



**NONRESIDENT
TRAINING
COURSE**



April 1994

Mess Management Specialist 3 & 2

NAVEDTRA 14164

Although the words “he,” “him,” and “his” are used sparingly in this course to enhance communication, they are not intended to be gender driven or to affront or discriminate against anyone.

PREFACE

By enrolling in this self-study course, you have demonstrated a desire to improve yourself and the Navy. Remember, however, this self-study course is only one part of the total Navy training program. Practical experience, schools, selected reading, and your desire to succeed are also necessary to successfully round out a fully meaningful training program.

THE COURSE: This self-study course is organized into subject matter areas, each containing learning objectives to help you determine what you should learn along with text and illustrations to help you understand the information. The subject matter reflects day-to-day requirements and experiences of personnel in the rating or skill area. It also reflects guidance provided by Enlisted Community Managers (ECMs) and other senior personnel, technical references, instructions, etc., and either the occupational or naval standards, which are listed in the *Manual of Navy Enlisted Manpower Personnel Classifications and Occupational Standards*, NAVPERS 18068.

THE QUESTIONS: The questions that appear in this course are designed to help you understand the material in the text.

VALUE: In completing this course, you will improve your military and professional knowledge. Importantly, it can also help you study for the Navy-wide advancement in rate examination. If you are studying and discover a reference in the text to another publication for further information, look it up.

*1994 Edition Prepared by
MSC Anthony Ellington and
MSC Cresencio Mariano*

Published by
NAVAL EDUCATION AND TRAINING
PROFESSIONAL DEVELOPMENT
AND TECHNOLOGY CENTER

**NAVSUP Logistics Tracking Number
0504-LP-026-8180**

Sailor's Creed

“I am a United States Sailor.

I will support and defend the Constitution of the United States of America and I will obey the orders of those appointed over me.

I represent the fighting spirit of the Navy and those who have gone before me to defend freedom and democracy around the world.

I proudly serve my country's Navy combat team with honor, courage and commitment.

I am committed to excellence and the fair treatment of all.”

CONTENTS

BASIC PART

CHAPTER	PAGE
1. Sanitation	1-1
2. Receipt, Inspection, Expenditure, and Storage of Food Items	2-1
3. Accounting	3-1
4. Foodservice Equipment	4-1
5. Food Preparation	5-1
6. Meat, Poultry, and Seafood	6-1
7. Nutrition and Menu Planning	7-1
8. Breads and Desserts	8-1
9. Foodservice.	9-1
10. Quarters Afloat and Ashore	10-1
11. Field Kitchens	11-1

ADVANCED PART

12. Foodservice Management	12-1
13. Foodservice Administration	13-1

APPENDIX

I. References	AI-1
II. Glossary of Terms and Acronyms	AII-1

INDEX	INDEX-1
-----------------	---------

INSTRUCTIONS FOR TAKING THE COURSE

ASSIGNMENTS

The text pages that you are to study are listed at the beginning of each assignment. Study these pages carefully before attempting to answer the questions. Pay close attention to tables and illustrations and read the learning objectives. The learning objectives state what you should be able to do after studying the material. Answering the questions correctly helps you accomplish the objectives.

SELECTING YOUR ANSWERS

Read each question carefully, then select the BEST answer. You may refer freely to the text. The answers must be the result of your own work and decisions. You are prohibited from referring to or copying the answers of others and from giving answers to anyone else taking the course.

SUBMITTING YOUR ASSIGNMENTS

To have your assignments graded, you must be enrolled in the course with the Nonresident Training Course Administration Branch at the Naval Education and Training Professional Development and Technology Center (NETPDTC). Following enrollment, there are two ways of having your assignments graded: (1) use the Internet to submit your assignments as you complete them, or (2) send all the assignments at one time by mail to NETPDTC.

Grading on the Internet: Advantages to Internet grading are:

- you may submit your answers as soon as you complete an assignment, and
- you get your results faster; usually by the next working day (approximately 24 hours).

In addition to receiving grade results for each assignment, you will receive course completion confirmation once you have completed all the

assignments. To submit your assignment answers via the Internet, go to:

<https://courses.cnet.navy.mil>

Grading by Mail: When you submit answer sheets by mail, send all of your assignments at one time. Do NOT submit individual answer sheets for grading. Mail all of your assignments in an envelope, which you either provide yourself or obtain from your nearest Educational Services Officer (ESO). Submit answer sheets to:

COMMANDING OFFICER
NETPDTC N331
6490 SAUFLEY FIELD ROAD
PENSACOLA FL 32559-5000

Answer Sheets: All courses include one “scannable” answer sheet for each assignment. These answer sheets are preprinted with your SSN, name, assignment number, and course number. Explanations for completing the answer sheets are on the answer sheet.

Do not use answer sheet reproductions: Use only the original answer sheets that we provide—reproductions will not work with our scanning equipment and cannot be processed.

Follow the instructions for marking your answers on the answer sheet. Be sure that blocks 1, 2, and 3 are filled in correctly. This information is necessary for your course to be properly processed and for you to receive credit for your work.

COMPLETION TIME

Courses must be completed within 12 months from the date of enrollment. This includes time required to resubmit failed assignments.

PASS/FAIL ASSIGNMENT PROCEDURES

If your overall course score is 3.2 or higher, you will pass the course and will not be required to resubmit assignments. Once your assignments have been graded you will receive course completion confirmation.

If you receive less than a 3.2 on any assignment and your overall course score is below 3.2, you will be given the opportunity to resubmit failed assignments. **You may resubmit failed assignments only once.** Internet students will receive notification when they have failed an assignment--they may then resubmit failed assignments on the web site. Internet students may view and print results for failed assignments from the web site. Students who submit by mail will receive a failing result letter and a new answer sheet for resubmission of each failed assignment.

COMPLETION CONFIRMATION

After successfully completing this course, you will receive a letter of completion.

ERRATA

Errata are used to correct minor errors or delete obsolete information in a course. Errata may also be used to provide instructions to the student. If a course has an errata, it will be included as the first page(s) after the front cover. Errata for all courses can be accessed and viewed/downloaded at:

<https://www.advancement.cnet.navy.mil>

STUDENT FEEDBACK QUESTIONS

We value your suggestions, questions, and criticisms on our courses. If you would like to communicate with us regarding this course, we encourage you, if possible, to use e-mail. If you write or fax, please use a copy of the Student Comment form that follows this page.

For subject matter questions:

E-mail: n313.products@cnet.navy.mil
Phone: Comm: (850) 452-1001, Ext. 2167
DSN: 922-1001, Ext. 2167
FAX: (850) 452-1370
(Do not fax answer sheets.)
Address: COMMANDING OFFICER
NETPDTC (CODE 313)
6490 SAUFLEY FIELD ROAD
PENSACOLA FL 32509-5237

For enrollment, shipping, grading, or completion letter questions

E-mail: fleetservices@cnet.navy.mil
Phone: Toll Free: 877-264-8583
Comm: (850) 452-1511/1181/1859
DSN: 922-1511/1181/1859
FAX: (850) 452-1370
(Do not fax answer sheets.)
Address: COMMANDING OFFICER
NETPDTC (CODE N331)
6490 SAUFLEY FIELD ROAD
PENSACOLA FL 32559-5000

NAVAL RESERVE RETIREMENT CREDIT

If you are a member of the Naval Reserve, you will receive retirement points if you are authorized to receive them under current directives governing retirement of Naval Reserve personnel. For Naval Reserve retirement, this course is evaluated at 12 points. (Refer to *Administrative Procedures for Naval Reservists on Inactive Duty*, BUPERSINST 1001.39, for more information about retirement points.)

COURSE OBJECTIVES

In completing this nonresident training course, you will demonstrate a knowledge of the subject matter by correctly answering questions on the following: sanitation; receipt, inspection, expenditure, and storage of food items; accounting; foodservice equipment; food preparation; meat, poultry, and seafood; nutrition and menu planning; breads and desserts; foodservice; quarters afloat and ashore; and field kitchens.

Student Comments

Course Title: Mess Management Specialist 3&2 _____

NAVEDTRA: 14164 _____ **Date:** _____

We need some information about you:

Rate/Rank and Name: _____ SSN: _____ Command/Unit _____

Street Address: _____ City: _____ State/FPO: _____ Zip _____

Your comments, suggestions, etc.:

Privacy Act Statement: Under authority of Title 5, USC 301, information regarding your military status is requested in processing your comments and in preparing a reply. This information will not be divulged without written authorization to anyone other than those within DOD for official use in determining performance.

NETPDTC 1550/41 (Rev 4-00)

CHAPTER 1

SANITATION

In a foodservice operation nothing can rival the importance of the sanitary aspects of food preparation and service. Carelessly handled food is easily contaminated with pathogenic organisms that may lead to illness. This chapter discusses the methods of preventing illnesses arising from poor sanitary practices in the preparation and service of food.

In addition to the hazards of food contamination, which Mess Management Specialist (MS) personnel have always contended with, modern warfare has added other hazardous chemical, biological, and radiological agents that may be used in any future war. Protection of the food supply and decontamination measures in the galley and messing areas are vital to the defense of the ship or station.

FOOD-BORNE ILLNESSES

Food-borne illnesses can incapacitate large numbers of personnel in a short period of time. In addition to the toxins or poisons produced by bacterial growth, certain foods are inherently or naturally poisonous. The poisons in these foods tend to attack the nervous system resulting in such symptoms as weakness or paralysis, numbness, tingling of the ears, apprehension, and even death.

Food-borne illnesses can be classified into the three following basic types: natural or chemical food poisoning, food intoxication, and food infection.

NATURAL OR CHEMICAL FOOD POISONING

Both natural and chemical food poisonings are caused by man; man's carelessness, indifference, or ignorance. Natural and chemical food poisonings are grouped together as one food-borne illness because they both occur naturally. The characteristics that differentiate natural and chemical poisonings are discussed next.

Natural Food Poisoning. In this type of food-borne illness, the food in its natural state contains elements poisonous to humans. As an MS, you will learn of many new foods that are not common to the United States.

Some of these foods are from plants and animals that can cause severe illness and even death when consumed.

Every effort is made to keep poisonous plants off a ship. But sometimes they do get aboard. Toadstools, hemlock mussels (such as those found on the West Coast during the summer), tropical fish (such as toadfish, puffing fish, and certain members of the jack fish family), and in tropical waters, at certain seasons of the year, barracuda can cause poisoning and death. Some types of mushrooms also contain natural poisons. Only an expert can decide whether or not a certain mushroom is fit to eat. The safest rule is to never use unfamiliar foods unless your medical officer approves their use.

Chemical Food Poisoning. Some food-borne illnesses are caused by chemical poisons. In the case of chemical food poisoning, the poisons are introduced into the food accidentally. The following types of chemical poisoning may be experienced in foodservice operations.

Antimony Poisoning

Antimony poisoning is caused by eating food cooked in poorly coated or chipped enameled cooking utensils.

Cadmium Poisoning

Cadmium poisoning may take place if chilled acid foods or drinks are allowed to stand in cadmium-plated metal containers before they are served. Illness may strike 10 to 15 minutes after the food is eaten. Lemonade, fruit punch, tomatoes, raspberry gelatin dessert, and tea containing lemon juice can be contaminated by cadmium. Also, ice trays and metal pitchers plated with cadmium can cause chemical poisoning when filled with cold acid foods.

Cyanide Poisoning

Cyanide poisoning may result if silverware is not properly washed and sanitized after detarnishing.

Zinc Poisoning

Zinc poisoning in food is rare. It may occur when acid foods are cooked in galvanized iron kettles. Outbreaks have occurred when apples have been cooked in this type of kettle.

Lead and Arsenic Poisonings

Lead and arsenic sometimes used to spray vegetables may cause these foods to become poisonous. Be sure all fresh fruits and vegetables are thoroughly washed before you cook them, or before they are eaten raw. Lead poisoning may also result from the ingestion of food or water that has been in contact with lead pipes, lead-plated equipment, and lead-soldered pots and pans. Lead is a cumulative poison; the accumulation of small doses in the body will eventually cause chronic lead poisoning.

Fluoride Poisoning

Fluoride poisoning is caused by sodium fluoride, a substance often used to get rid of cockroaches. It is a white powder that can be easily mistaken for powdered milk. Keep all containers of such poison out of the galley and bakeshop.

Methyl Chloride Poisoning

Methyl chloride poisoning is caused by leaking mechanical refrigerators. Check your equipment for such leaks and request scheduled planned maintenance service (PMS) from the engineering division to detect faulty equipment.

FOOD INTOXICATION

This type of illness is caused by toxins. Under favorable conditions certain bacteria produce chemical compounds called toxins, which, if ingested, cause food intoxication. Staphylococcus is the most commonly reported food intoxication.

Staphylococcus

The staphylococcus germ is found in the throat, on the skin in pimples and boils, and in great abundance in the postnasal drip of people recovering from colds. Consequently, the most prevalent carrier of food intoxication is foodservice personnel. People with any of these symptoms must not be allowed to work in food preparation spaces in any capacity.

Foods most associated with outbreaks of staphylococcus are pork products and fowl. Ham is also susceptible to staphylococcus poisoning and must not be sliced too far in advance of serving unless properly refrigerated.

Other foods commonly involved are potted meats, fish, cheese, milk products (including cream- and custard-filled pastries), and potato and macaroni salads. Foods can contain sufficient toxin to cause food poisoning and yet have no odor of spoilage and no abnormal taste. Even when food has been properly refrigerated, it can become contaminated by bacteria while it is being prepared or while it is standing in the galley before it is served.

Botulism

Botulism is a second type of food intoxication. This disease, usually fatal, is caused by the toxin produced by the rod-shaped bacterium called clostridium botulinum. Botulinum organisms are found in the soil and gain access to foods through contact with soil, dust, and possibly water.

The foods most often responsible for botulism are either canned or fermented foods in which the preserving process has not succeeded in destroying the bacteria in the food. The botulinum grows and multiplies in an airtight container. However, when cans are damaged, leak, bulge, or are sprung, the contents are presumed to be unsafe.

The botulinum organisms sometimes produce a gas and cheesy odor in food, but the absence of these signs does not necessarily mean that the bacteria are not present.

FOOD INFECTION

This type of food illness is caused by microorganisms such as the salmonella, shigella, and clostridium species and the streptococcus, bacillus, and typhoid fever bacteria. A large percentage of food infections are transmitted by foods that have been allowed to remain at room temperature for a prolonged period of time.

The great majority of outbreaks of food infection is caused by meat (poultry, particularly turkey) and meat mixtures. For this reason, poultry dressing should not be served as a leftover. Other foods that may be involved are custards, milk cream, ice cream, seafood, meat, eggs, meat products, shellfish, salads, mayonnaise,

salad dressings, poultry dressing, bread puddings, cream pies, eclairs, and filled pastries.

These microorganisms are transmitted to the food by personnel who are sick or carriers and who are allowed to handle food in the food preparation area.

Salmonellosis

Salmonella bacteria are transmitted by foods, usually from undercooked or semicooked raw foods, or from foods that have become infected after cooking by persons who are harboring the bacteria. Since salmonella bacilli leave the body through the intestinal tract, the main source of salmonella infection is people who do not wash their hands after leaving the head. Consequently, they contaminate all the food they handle. Also, mice, rats, and cockroaches may contaminate food by dragging filth over food and food utensils, or by intestinal deposits that are brushed off into food or containers.

While no specific foods may be said to be responsible for salmonellosis, the ones most likely to harbor the salmonella bacilli are (1) those that are usually eaten raw such as salads and greens; (2) cooked leftover foods that are not reheated thoroughly; (3) foods that are undercooked, especially poultry and uninspected meats; and (4) infected eggs that are eaten raw or undercooked. See "Safe Egg-Handling Guidelines" in chapter 1 of NAVMED P-5010.

Streptococcus

Infections such as septic sore throat and scarlet fever are transmitted by contaminated milk and by certain other foods, including meat, meat products, and dressings. One type of this infection also causes a gastrointestinal disturbance. Floor dust is one of the modes of transmission.

Typhoid Fever

Typhoid fever is transmitted by milk, shellfish, or water supplies that have become polluted with the urine or feces of a person harboring the organism of this disease. It is also spread by human carriers and flies that transport the typhoid bacteria from soiled articles to foods, dishes, and cooking utensils.

Bacillus Dysentery

Bacillus dysentery is transmitted by contaminated foods or water, by human carriers, or by flies. The

bacilli of this disease are found in the bowel discharges of infected persons.

Infectious Hepatitis

Infectious hepatitis is a form of liver disease with symptoms of general discomfort. Jaundice, often characterized by skin yellowing, and other signs of liver injury are sometimes present. The disease is highly contagious. Drinking water or unsanitary conditions and flies or other biting insects may transmit the infectious material.

ANIMAL PARASITES

Animal parasites sometimes enter the body in food and produce infections. Some of these forms of animal life are one-celled. All are so tiny that they are not visible when the food is being prepared.

Amoebic Dysentery

This illness is caused by a one-celled animal, the amoeba. These organisms eat the red blood corpuscles of the body and the cells that line the intestines. The dysentery-producing amoeba is transmitted by foods served cold and moist, such as celery, lettuce, other fresh vegetables, or fresh berries. These foods may be infected by human excretions, by flies, or by having been grown in fields where animal excreta was used as fertilizer.

Trichinosis

Eating infected pork that has not been thoroughly cooked is the most common cause of trichinosis. All fresh pork products must be cooked to an internal temperature of 165°F or above to kill the trichinella worm. Since there is no way of knowing whether or not this parasite is present, the pork must always be thoroughly cooked.

Beef Tapeworm Infection

Beef tapeworms are transmitted by infected beef that has not been cooked long enough to kill the encysted larvae. To prevent ingesting the beef tapeworm, only government-inspected beef should be used. If it is necessary to use beef that has not been inspected, freeze it at 14°F or below for 5 days or longer, or pickle it in a 20- to 25-percent salt solution for 5 days or longer. Cook it well-done; never serve it rare.

Fish Tapeworm Infection

Fish tapeworm is transmitted by infected fish that has not been thoroughly cooked. For purposes of safety, always make sure fish is thoroughly cooked and is never tasted in the raw state.

MOLDS AND YEASTS

Other types of cell life that may not be harmful are molds and yeasts.

Molds

Molds are composed of many cells and maybe very small or large enough to cover an entire wall. They grow best in dark, damp places where temperatures are favorable. Some molds are valuable in the production of medicines such as penicillin; other molds may cause certain infections in human beings.

Molds spoil the taste of food and eventually destroy it. Molds may be removed from certain foods and the remainder of the food used. Consult your medical department on the precautions to be taken.

Yeasts

Like bacteria, yeasts are single-celled. They reproduce by budding. When a bud becomes sufficiently large, it separates from the original cell and becomes an independent cell. Certain yeasts are used in breadmaking, vinegar fermentation, and the manufacture of beverages.

FOOD PREPARATION

It is evident that the foodservice worker is the most important link in the transmission of disease through food. The workers' health, personal habits, understanding of bacteria, and the methods of preparing and serving of food are of concern not only to themselves but also to their shipmates as well.

BACTERIA

An understanding of bacteria is valuable to all personnel and essential to those who work with food in any way. Bacteria are one-celled microorganisms; so small they are visible only under a microscope. They are widely distributed in the air, water, soil, and in animal and plant tissues. Bacteria are classified according to their shape. Those round in shape are

called cocci; the rod-shaped ones are called bacilli; and the spiral-shaped ones are called spirilla.

Since bacteria cannot be seen, our best defense against the harmful bacteria is strict adherence to sanitation principles. Bacteria can move of their own accord only in liquids and cannot leave a fluid surface unless transported as "passengers" by other agents such as dust, food dishes, silverware, cooking utensils, dirty fingers or fingernails, a common drinking cup, a hand towel, water, insects, or rodents.

Bacteria reproduce themselves simply by dividing in half. On the average each bacterium, under favorable conditions, will divide and become two bacteria every 20 minutes. The rate of multiplication or growth of bacteria is affected by heat or cold. Certain types of bacteria, if allowed to grow and multiply, produce toxins that cause food poisoning. Boiling will kill all bacteria, but it will not kill the toxins once they are allowed to form. Certain strains of the staphylococcus bacteria will withstand boiling temperature for long periods of time before they are killed and are virtually impossible to kill by normal cooking methods. Once toxins have been allowed to form, no amount of cooking will make the food safe. Refrigeration will prevent the bacteria from producing toxins but will not kill the toxins once they are formed.

FOODSERVICE PERSONNEL

Since foodservice personnel are considered to be the most likely mode of transmission of disease through food, certain requirements such as medical examinations, sanitation training, and personal hygiene must be completed before such personnel can work in food preparation areas.

Physical Examination

All foodservice personnel including personnel employed by civilian contract services must be examined and determined to be free from communicable diseases before initial assignment in foodservice. Subsequent physical examinations will be conducted annually. The physical examination must be sufficiently comprehensive to detect acute or chronic diseases. Laboratory tests and other diagnostic determinations are performed at the discretion of the senior medical officer; however, all foodservice personnel must be examined for evidence of tuberculosis. Employees of contract services must be examined by either local or military medical

departments to make sure a complete and thorough physical examination has been done.

Personnel having any open lesions, particularly on the hands, face, or neck or acne on the face, are prohibited from performing foodservice duty.

Examination of personnel with questionable medical or social histories must be comprehensive including X-ray of the chest, stool and urine examinations for parasite and bacterial pathogens, and other such determinations as may be indicated by international agreements.

All personnel must repeat medical tests when away from duty for 30 days or more. All personnel must submit to laboratory examinations and other tests to detect and treat acute or chronic diseases and be relieved from duty if they are infected.

Training

All foodservice personnel must be thoroughly indoctrinated in personal hygiene and food sanitation, as well as in the methods and importance of preventing food-borne illness. Temporary foodservice personnel must be indoctrinated as follows:

- All foodservice personnel will receive a minimum of 6 hours' initial training and 6 hours' annual refresher training in foodservice sanitation principles.
- All foodservice sanitation training will be conducted by environmental health officers and/or preventive medicine technicians.

In those cases where it can be shown that environmental health officers or preventive medicine technicians are not available to perform such training, medical department representatives, MSs in paygrade E-5 and above, or civilian foodservice supervisors who have received special training to qualify them as foodservice sanitation instructors maybe used. Special instructor certification training may be taken at either a Navy environmental and preventive medicine unit or naval regional medical center preventive medicine service, and completion of training must be documented. Certified instructors must use and maintain up-to-date, standard Navy lesson plans in their training programs. Instructors must be recertified every 3 years and are authorized to sign the Foodservice Training Certificate, NAVMED 4061/1.

Personal Hygiene

The group of principles and rules designed to promote personal health and cleanliness is known as personal hygiene. The following procedures should be used to ensure personal cleanliness.

TAKE DAILY SHOWER OR BATH.— Maintain a high degree of cleanliness by thoroughly soaping and rinsing the body to remove dirt, perspiration, and bacteria. This practice improves circulation, appearance, and health, and is the foundation of personal hygiene. Frequent washing of hair is mandatory. Keep teeth clean by brushing at least twice daily, but preferably after each meal.

WEAR CLEAN GARMENTS.— Wear clean inner and outer garments. Germs are harbored in clothing as well as on skin surfaces, and diseases are likely to be transmitted. Caps (or hairnets for women) completely covering the hair must be worn at all times when working with food. Keep hair trimmed for neat appearance. Change clothing and aprons soon after soiling.

WASH HANDS BEFORE STARTING AND AFTER FINISHING WORK WITH FOOD.— Provide plenty of hot and cold running water under pressure. Soap and paper towels with adequate waste receptacles must be available. Continuous rolled paper toweling that is sanitary may be used if it is approved by the National Sanitation Foundation Testing Laboratory or meets equivalent standards, but use of such toweling must be supervised.

Thorough washing of hands with hot soapy water to remove soil and contamination before commencing work is mandatory. After each visit to the toilet, all food handlers are required to scrub hands and nails. When interruptions occur during routine duties in the galley, personnel are required to wash their hands before resuming work. Frequent washing of soiled hands during work is also essential. Never wear an apron to the toilet or washroom.

Hands are probably the most common vehicle for transmitting germs. Personnel should keep fingernails closely clipped, trimmed, and cleaned underneath and around cuticle. Cleaning is effective only with soaps or detergents and warm water. Unless clean towels or other satisfactory hand-drying devices are provided, the benefits of frequent hand scrubbing are completely nullified.

PROHIBIT USE OF TOBACCO.— Smoking in food preparation, serving, or dishwashing areas is

DAILY SHOWER



FOR HEALTH AND CLEANLINESS

CLEAN CLOTHES



INSIDE AND OUTSIDE

FREQUENT HANDWASHING

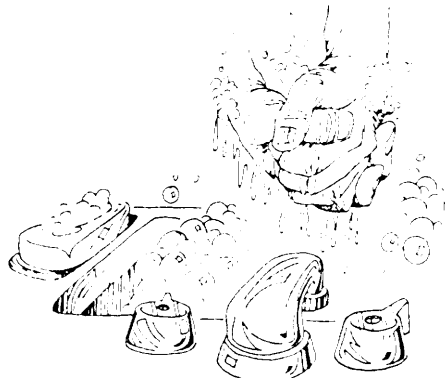

VERY IMPORTANT

CLEAN SHORT NAILS

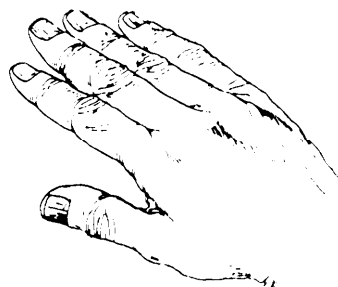

REDUCE DISEASE TRANSMISSION

HAIR CONFINED—WASHED

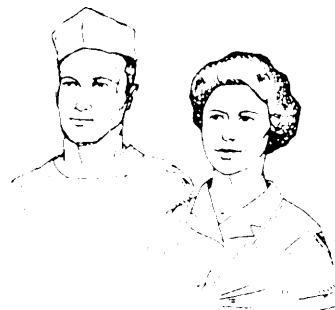

CAP

NET

Figure 1-1.—Good daily health habits for foodservice personnel.

prohibited. The use of tobacco while preparing or serving food may contaminate the fingers and hands with saliva and may promote spitting and coughing, which transmit disease organisms present in the saliva to food or food-contact surfaces. If smoking areas away from the galley are provided, personnel should use these

designated areas, but thoroughly scrub hands before resuming work to prevent food contamination.

DEVELOP SANITARY WORK HABITS.— A wide range of communicable diseases and infections may be transmitted by food handlers to other personnel through contaminated food and careless practices.

Some of the desirable work habits that personnel should develop to prevent personal contamination areas follows:

- Spoons, knives, and forks should be picked up or touched only by their handles.
- Cups, glasses, and bowls should be handled so that fingers and thumb do not contact inside surfaces or lip-contact surfaces.
- Portable- and fixed-food preparation equipment should be stored so that they require minimum handling by personnel. Improper storage ruins the effect of sanitizing, and excess handling will introduce contaminating material.
- Disposable dinnerware must be handled and dispensed to prevent contamination of surfaces that come in contact with food or with the mouth of the user.
- Tongs, picks, spatulas, scoops, dipping spoons, and other suitable utensils must be used in such a manner to keep manual contact with food at a minimum.

Figure 1-1 shows some of the good daily health habits for foodservice personnel.

REPORT PERSONAL ILLNESS AND ALL MINOR INFECTIONS.— Boils and sore throats are sources of bacteria that can cause severe food-borne diseases. When ill, report it and make arrangements to be relieved of duty. Sores, rashes of any kind, pimples, or other skin eruptions as well as cuts should be reported and medical aid solicited as soon as possible. Both supervisory personnel and operators are responsible for notifying medical personnel if a disease is suspected.

APPLY PROFESSIONAL TRAINING AND TECHNIQUES.— All personnel must be alert to the hazards associated with speedup methods and shortcuts to washing and sanitizing operations. Techniques of sanitizing—including times, temperatures, and routines—should be memorized and applied. The effectiveness of sanitation is directly related to the competence and cooperation of foodservice personnel.

COMPLY WITH SANITARY REGULATIONS.— Public health ordinances and regulations imposed by the Bureau of Medicine and Surgery (BUMED) must be observed in day-to-day foodservice operations. Recognized standards of sanitation embracing accepted public health principles are prescribed by these sources and administration of regulations at each activity will be enforced. Figure 1-2 shows correct and safe work habits you should develop and practice.

PRECAUTIONS

Most food-borne disease outbreaks are due to four factors: (1) preparation of food too far in advance, (2) poor refrigeration of food, (3) careless handling of food, and (4) failure of personnel to follow good personal hygiene habits.

The following precautions should be observed in preparing and serving food:

- Food should be served promptly after it is prepared.
- Any food that has been ground or chopped and is to be cooked later or incorporated in a prepared dish must be refrigerated immediately. Such ground or chopped food should be refrigerated until cooked; once cooked, they should never be saved as leftovers. When food is ground, an increase in the area of contamination and growth of harmful bacteria results. When chilled foods are ground, the grinding process warms the food to the point where bacteria growth may start.
- Place meats that are cut, sliced, or diced in shallow containers, cover with lids or with waxed paper, and refrigerate immediately. The temperature of the meat-cutting room should be maintained at 50°F. Improper handling of meats can result in spoilage as well as in the transmission of disease.
- If you are using individual serving containers, do not put ice on top of containers.
- All fresh pork products must be cooked to an internal temperature of 165°F or above. Never serve raw pork products.
- Keep foods covered at all times except during actual preparation and serving.
- Palletize all subsistence items in storage spaces to facilitate cleaning and air circulation.
- Keep all worktables and benches clean at all times.
- Store food off the deck.
- Keep food preparation utensils, meat grinders, and other similar equipment clean and handle them properly. Food that comes in contact with equipment that is contaminated becomes contaminated also.
- Wash your hands before preparing food.



DON'T BE A THREE-FINGER JOE



USE TWO HANDS OR A TRAY



DON'T BE A BUTTERFINGERS

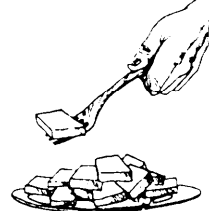

USE A FORK

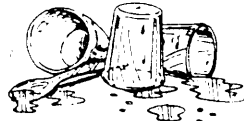

**THOSE YOU SERVE
CAN TRANSMIT A DISEASE TO YOU!**



DON'T



DO



**DON'T PASS BY WASHBOWL
WASH HANDS**



DON'T

Figure 1-2.-Develop and practice correct and safe work habits.

- Do not cough, sneeze, or talk over food while it is being prepared or served.
- Never smoke while you are preparing food. Saliva can be dropped on foods very easily when you are smoking.
- Keep fingers away from the mouth, lips, and face.
- Handle foods as little as possible.

- Use tongs to handle butter, doughnuts, bread, and other similar items of food. Do not use your hands.

Inspections

To make sure all foodservice division rules and directed procedures are being followed, the food service officer and/or designated assistants should make both unexpected daily inspections and thorough weekly inspections of all foodservice personnel, spaces, and

operations. As an aid to conducting an inspection the following items should be checked:

Food handlers. Clean personal appearance that includes clean working uniform (including apron and cap), haircut, clean shave, close-clipped fingernails, head covering, neatness in dress, and absence of cuts, sores, acne, or other indications of skin disorders on exposed parts of head, hands, or arms.

Galley. Deck drains, sinks, and grease traps must be clean and free of any dirt and food particles. Inspect for insect and rodent infestation.

Ranges and grills. Clean and free from grease (ovens, unit cover, drip pan, range grease receptacles, hood and hood filters).

Can opener and base. Clean and free from accumulated grime and food particles.

Deep-fat fryers. Clean, coils clean, basket clean, and in good condition.

Steam-jacketed kettles. Clean under cover and cover-exhaust opening; lids and spigots easily removable without tools for cleaning. Drain clean and free of food particles.

Ovens. Clean and free of burned food and food particles.

Sinks and galley utensils. Clean and neatly stored; steel and plastic sponges (but not steel wool) used for cleaning galley utensils are clean and free of food particles, air dried, and neatly stored.

Mixing machines and attachments, ice-cream machine, meat and vegetable grinders and attachments, and proof boxes. Clean and in good operating conditions.

Cutting boards. Clean and dry, no evidence of cracks or pitted surfaces.

Vegetable-preparation room. Inspect for cleanliness of deck, drains, traps, and sinks. Look for any sign of insect and rodent infestation.

Potato-peeling machine. Dismantled (cover and disk removed), wash-water strainer clean and in good condition.

Slicing and dicing machine. Dismantled, clean (parts oiled if not in use), and in good condition.

Dining area. Inspect for cleanliness of decks, tables, benches, serving tables, coffee urns, milk dispensers, warming ovens, water fountains, and ice

machines; all gear clean and neatly stored. Look for insect and rodent infestation.

Scullery. Decks and gear must be clean. Dishwashing machine dismantled, clean and free of odors, spray pipe clean, racks clean and in good condition, curtains clean and in good condition, thermometers operating properly, and trash and garbage cans clean and tightly covered

Garbage and trash room. Clean, orderly, and free from obnoxious odors; cans clean and tightly covered. Inspect for insect and rodent infestation.

The 4-Hour Rule

Protein foods that are not served immediately after they are cooked should either be chilled to temperatures of 40°F or lower (but not frozen) or held at 140°F or higher. Protein foods include meats, fish, poultry, gravies, meat stocks, soups, eggs, custards, cream fillings, and milk. Growth of harmful bacteria and the development of toxins (poisons) formed by the bacteria occur rapidly in cooked protein foods during holding at temperatures between 40°F and 140°F. Cooked protein foods that have been held at temperatures between 40°F and 140°F for more than 4 hours will be considered unfit for consumption and must be destroyed.

This principle is known as the 4-hour rule. If the product is refrigerated at intervals and then permitted to warm up, the total time of the various periods between 40°F and 140°F must not be more than 4 hours. Protein foods composed of ingredients that are hand-peeled, hand-sliced, or hand-diced after they are cooked should never be used as leftovers; the 4-hour limit between temperatures of 40°F and 140°F is usually taken in preparing, chilling, and serving the food. These foods include potato, chicken, macaroni, shrimp, and egg salads and similar items. Hand preparation not only increases the chance of contamination, but generally increases the length of time that these foods are held at room temperatures. It is also dangerous to return opened jars or bowls of mayonnaise and cooked salad dressing from the salad bar to the refrigerator for reuse at a later meal because of the danger of miscalculation as to the total time that has elapsed from the time that these salad dressings have been held at temperatures between 40°F and 140°F.

Holding Temperatures

Holding temperatures are of utmost importance. Food held at temperatures that are too high or too low

can ruin both the taste and the appearance of food as well as increase the risks of food-borne disease.

HOT FOODS.— The holding temperature of hot foods held on a serving line should be maintained between 180°F and 200°F.

COLD FOODS.— Keep cold foods such as salads, potato salad combinations, and ham plates cold by setting them on ice or on refrigerated salad bar units maintained between 34°F and 40°F.

BEVERAGES.— Beverages should be served hot or cold as applicable. As with food, the quality depends on proper preparation, holding, and dispensing.

Leftovers

When leftovers or warm foods are chilled, care must be taken to ensure prompt and thorough chilling (40°F or below) to the center of the food mass. Foods that are to be refrigerated should be placed in shallow pans to a depth of not more than 3 inches and must be covered with lids or waxed paper. Do not put leftovers in large, deep pans as chilling may take so long to get to the center of the food mass that sufficient time is allowed for the growth of harmful bacteria and development of toxins. Guard against any procedure that might delay cooling. Place foods to be chilled in the chill box immediately. Leftover food must not be saved for more than 36 hours. Freezing of leftovers is prohibited. Foods composed of ingredients that have been peeled, sliced, or diced by hand after cooking must never be used as leftovers since the 4-hour limit between temperatures of 40°F and 140°F is usually taken up in preparing, chilling, and serving the food. To prevent miscalculations in the length of time leftovers have been stored, all leftovers must be labeled with the date and time of preparation.

Frozen Foods

Frozen foods should be thawed in the refrigerator. Freezing breaks down tissue and, therefore, foods can be invaded by germs more rapidly. Once foods are frozen and then thawed, they must not be refrozen. If not eaten, they should be stored under 40°F.

Milk and Milk Products

Milk and milk products and other protein foods are frequent offenders in transmitting infectious diseases to man because of their rapid rate of perishability. Strict surveillance of all handling procedures from cow to man is necessary to prevent contamination and possible milk-borne diseases.

When procured by Navy and Marine Corps activities, milk and milk products must conform in all respects to either federal or military specifications. The perishability of such products is a most important factor, thus strict compliance with all sanitary requirements is mandatory.

Delivery inspections of dairy products are normally conducted by personnel attached to the receiving activities. These inspectors must make sure milk and milk products are from approved sources and delivered in containers that are in good condition and properly sealed. They must make sure the temperature of the product on delivery is 40°F or less or follows the current Defense Personnel Support Center (DPSC) contract.

Of prime importance to medical and foodservice personnel is the maintenance of recommended temperatures in storing (40°F or less), dispensing (32°F-40°F), and enforcing approved sanitary methods in the handling of such products.

Fresh Fruits and Vegetables

Fresh fruits and vegetables should be washed thoroughly under running water to remove any particles of dirt or to remove poisonous insect sprays. Green vegetables of uncertain origin should be suspected of being contaminated with pathogenic organisms. They should be chemically sanitized by immersion for at least 15 minutes in a 100-ppm (parts per million) available chlorine solution, or 30 minutes in a 50-ppm available chlorine solution, or other approved method. Then they should be thoroughly rinsed with potable water before they are cooked or served. Head items such as lettuce, cabbage, or celery must be broken apart before they are sanitized.

Canned Products

Canned foods that appear abnormal in odor or appearance should never be eaten or even tasted, but should be discarded. When you are inspecting canned meats, fish, poultry, vegetables, fruit, and juices, the following factors should be considered.

CAN LABELS.— Check to make sure contents and processing date are stamped on the end of the container or on the label.

CAN EXTERIOR.— The exterior of the can should be examined for general appearance, dents, swelling, rust, and pinholes. Cans having severe dents that cross either the side or end seams or that crinkle the metal to a point similar to those depicted in figures 1-3,

1-4, and 1-5 should not be used. Rusty cans maybe used provided the rust does not penetrate the can. Rust that can be wiped off is not penetrating.

CAN INTERIOR.— Contents should be removed, the can rinsed, and the interior examined for pinholes against a strong light. If pinholes are present, contents should be discarded.

CONTENTS.— Contents of can should be examined for characteristic odor and appearance of the product.

REJECTION OR SURVEY.— Except for coffee and molasses, foods contained in cans displaying the following conditions are unsatisfactory and should be surveyed and disposed of:



Figure 1-3.—Severe angularly dented can with crimping of body.

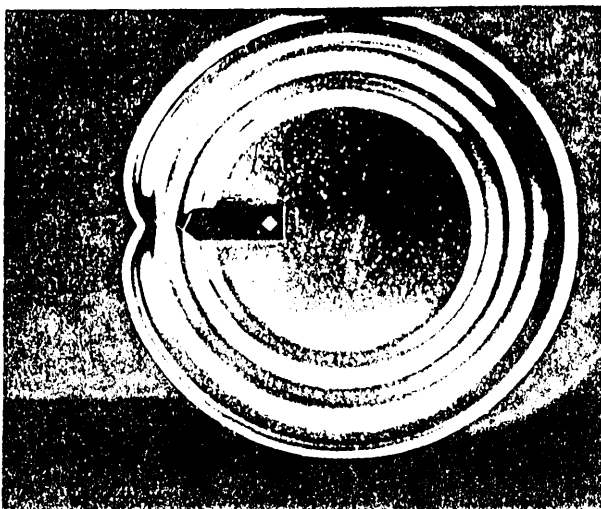

Figure 1-4.—Severe dent that buckles end seam of a can.



Figure 1-5.—A severely dented can in which the end seam is pulled out of position.

Pinholes—tiny holes caused by action of food acids during prolonged storage.

Swells (or swellers)—both ends of cans bulge outward because of bacterial action and gas production. Ends do not yield to finger pressure. (Molasses may bulge in tropical areas, but this condition is not dangerous and the product need not be rejected for this reason.)

Springers—one or both ends bulge outward because of bacterial action and gas. However, this bulge will yield on pressure and spring back to bulge condition on release. Springers or swellers of coffee containers, however, usually indicate a properly sealed container that has merely retained natural coffee-bean gases.

Flippers—both ends are flat, but one end will bulge outward when the opposite end receives pressure. This condition is caused by either bacterial action or chemical action resulting in gas production.

Spoiled or Damaged Food Products

Several precautions eliminate the factors that cause spoiled or damaged food items. These precautions include inspection for quality upon receipt, proper storage and handling, and maintenance of required temperatures relative to each respective phase of the operation. The absence of any one of these precautions may encourage food spoilage and damage.

The following hazardous material should be disposed of accordingly, using the applicable survey procedures outlined in NAVSUP P-486, volume I:

- Cans in unsatisfactory or surveyable condition

- Food products with spoilage or damage indicated by offensive odors, presence of slime, abnormal color, or other evidence of deterioration

- Food items adulterated by easily recognizable foreign material such as metal, glass, dirt, or insects

Do not attempt to taste or cook food in these states. It is safe to observe the old saying, "When in doubt, throw it out." The risk of food-borne illness must be avoided. After any occurrences of spoiled or damaged food, corrective actions must be provided and measures must be designed to prevent future occurrences.

KEEPING UTENSILS AND EQUIPMENT CLEAN

All phases of sanitation in a general mess are important. However, one of the most important is the proper cleaning and sanitizing of equipment (including trays, dishes, and other dinnerware) used for preparing, handling, cooking, and serving food.

Dishes may be washed by hand or by machine. Whatever the method, the final results may either be excellent or poor, depending upon how conscientiously you apply your knowledge and skill in using the equipment and materials provided. The best equipment and detergents will not do a good job of dishwashing if used improperly.

Types of Soil

Unless the galley equipment and utensils are thoroughly cleansed, food particles in which bacteria may grow will remain on them. These food soils are divided into several distinct types:

Freshly deposited soil—the soil that remains immediately after the equipment or utensil has been used.

Thin film—the soil that remains as the result of ineffective cleaning, following a flushing with water. Thin films are not easily seen and they are capable of sustaining germs.

Built-up deposits—the result of repeated ineffective cleaning methods causing a day-by-day accumulation of soil.

Dried deposits—accumulations that result from drying action and formation of a heavy crusty deposit.

Baked deposits—deposits that have been baked onto equipment and have become difficult to remove.

Removing Stubborn Soils

The Navy procures the correct type of detergent to be used in washing food preparation utensils and equipment. Hot water also provides temperatures that increase the chemical activities of the various ingredients in properly compounded detergents. Friction is an important part of cleaning. The required friction may be applied by brushing with approved brushes or by strong flushing, as in dishwashing machines. A hard abrasive should never be used on any metal surface. This results in scratches that provide lodging places for soil. It is recommended that pots and pans, cooking utensils, and other such items be presoaked to loosen any food clinging to the utensil. Then, they should be washed using the proper detergent compound and hot water. A detergent increases the effectiveness of the water as a cleaning agent. The washed pots and pans must be rinsed with warm water at 120°F to 140°F, then sanitized for 30 seconds in hot water of 170°F or for at least 1 minute in an approved chemical sanitizing solution such as the standard stock chlorine-iodine type. Once washed and sanitized, the clean pots and pans should be stored, bottoms up, in clean racks. Otherwise, the effort spent in washing and sanitizing them is wasted. Figure 1-6 shows the

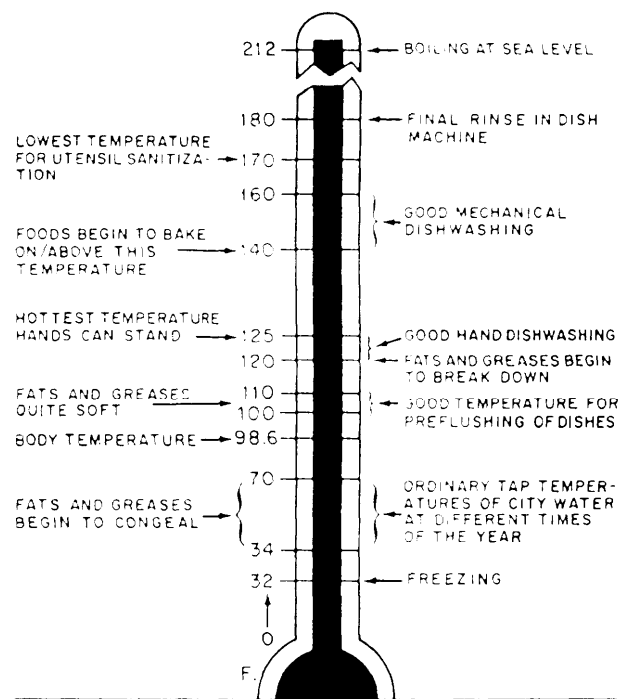

Figure 1-6.—Temperatures necessary for proper sanitizing of foodservice equipments and utensils.

temperatures necessary for the proper cleaning and sanitizing of foodservice equipment and utensils.

Hand Dishwashing

The equipment provided for manual dishwashing varies from a one-compartment sink to the preferred three-compartment sink. A remote dial thermometer and a booster heater should be installed under the final

rinse compartment. Regardless of the type of sink on board your ship or station, the procedures outlined in figures 1-7 and 1-8 should be filled.

Machine Dishwashing

High-standard dishwashing demands that the machine be kept clean inside and out. Lime deposits from water should not be allowed to accumulate inside

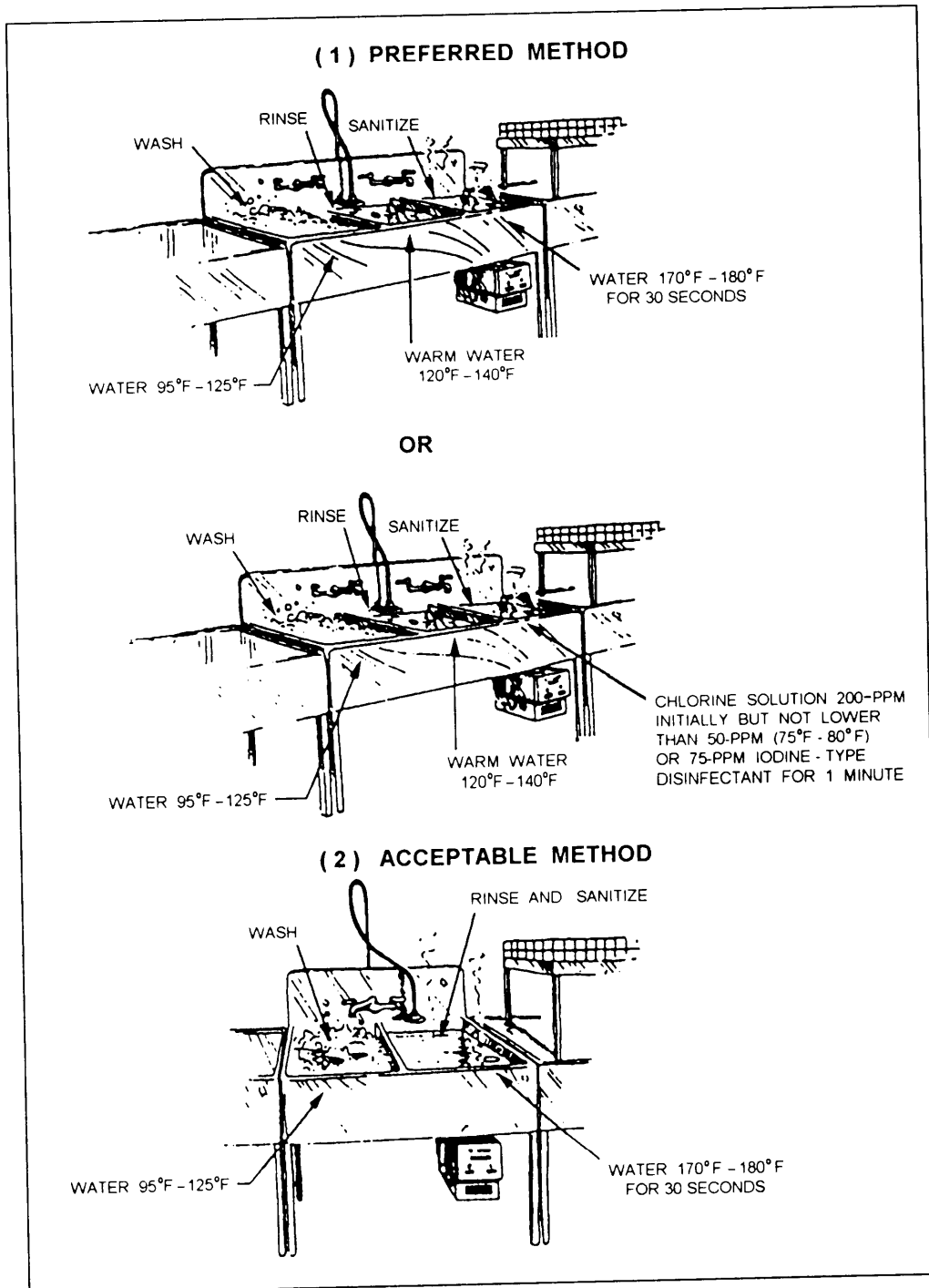

Figure 1-7.—Methods for manual washing of dishes and cooking and serving utensils.

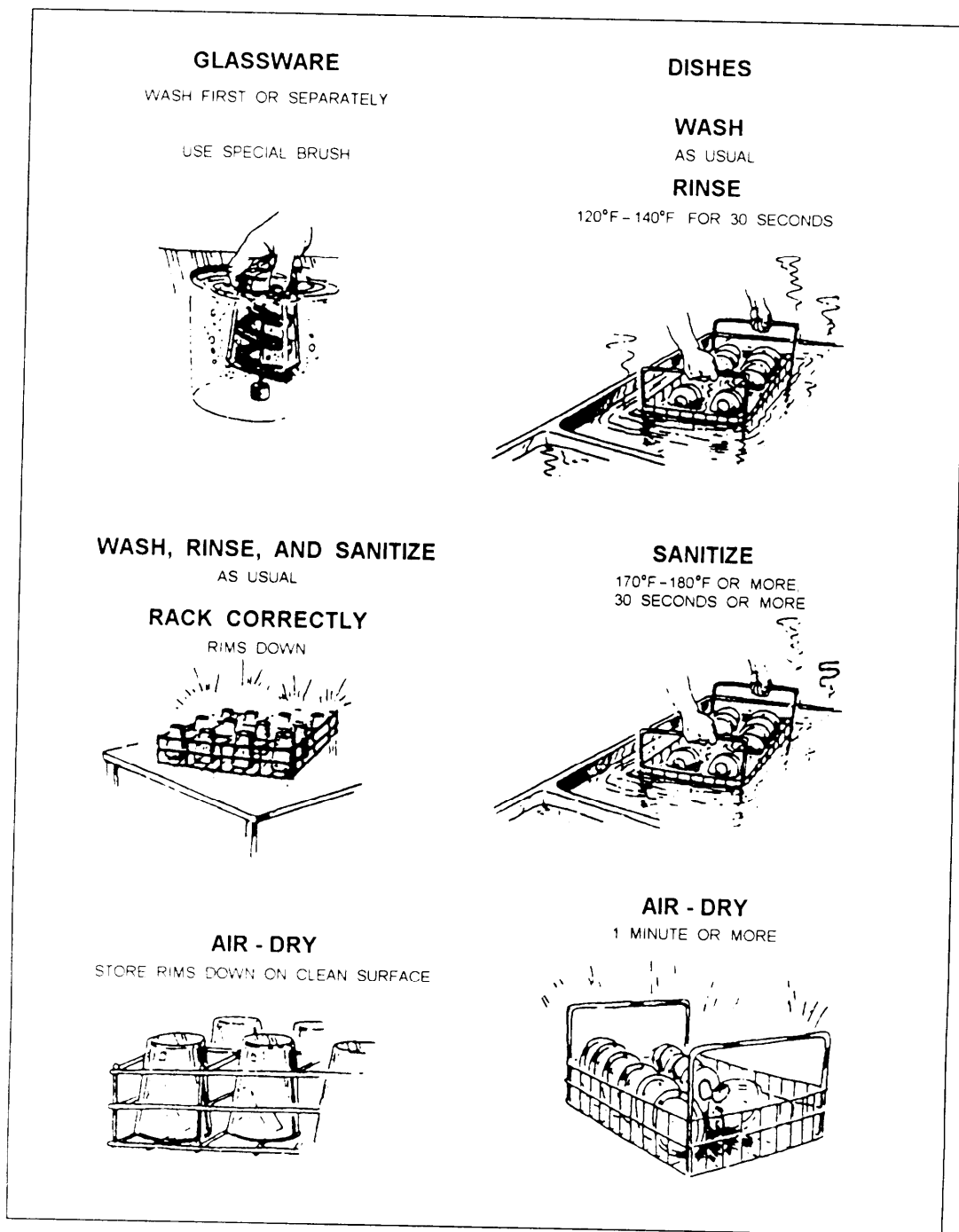

Figure 1-8.-Checkpoints in manual dishwashing.

the tanks even to slightest degree. The machine must look and smell clean.

Machines properly maintained will operate with efficient service over a long period of time. If neglected, dishwashing machines, like any piece of mechanical equipment, will bring on costly repairs and decreased efficiency in cleaning and sanitizing.

Preflushing of dishes will help avoid clogging of spray nozzles with food particles. Clean wash water will prevent a buildup of bacterial population and subsequent contamination. Do not let wash water enter the rinse tanks. A dishwashing machine is not a garbage disposal, and an accumulation of food scraps and grease greatly hampers the washing operation. Check the

water flow pressure, using a proper gauge. On spray-type machines, flow should not be less than 15 pounds per square inch nor more than 25 pounds per square inch for the final rinse.

The procedure for racking gear for washing is equally as important as preflushing. All items should be racked to permit washing solutions and spray rinses to contact the surfaces of the articles. Overloading as well as improper placement of items on racks will impede the operation.

SANITATION OF FOODSERVICE SPACES

Galleys, the bakeshop, vegetable preparation areas, food storage and refrigeration facilities, and any other facilities or equipment in which food is prepared, served, or dispensed constitute the total physical plant of the foodservice operations. It is mandatory to keep these spaces in sanitary condition at all times.

Decks, Bulkheads, and Overheads

Regular after-meal cleanup is necessary to prevent an accumulation of filth, and frequent in-between cleaning is required if deck cleanliness is to be maintained at a peak standard. When food is spilled, it should be wiped up immediately.

No attempt should be made to sweep down decks and dining areas during food preparation and service, as dust rises in the air and will fall on foods and worktables. Pick up wastes and deposit them in proper receptacles.

Vacuum cleaning is the recommended method for dry cleaning bulkheads and overheads.

Ventilation System

Good air circulation is a basic requirement of proper sanitation because it reduces condensation of steam and minimizes heat, vapors, smoke, fumes, odors, and soiling. Mold and bacterial growth are inhibited whenever there is ample, dry, clean air.

Prevent grease from accumulating on hood appliances. Accumulations of grease can drip either into food being prepared or onto surfaces of equipment where contamination of food is possible. Filters should be removed and soaked in a hot (180°F), strong detergent solution. Scrub with a brush. Rinse under running water or by applying steam from a hose. Removable filters may be run through the dishwashing machine.

Lighting System

Sufficient lighting in all areas of food storage, preparation, and service, and in scullery operations is a fundamental requirement of proper sanitation and safe working conditions. Grease, dirt, and vermin can be more easily detected and corrected where there is ample light.

Routine cleaning of light fixtures and light bulbs will contribute to adequate lighting and eliminate the accumulation of dirt and grease film.

Storage Areas

Fresh and frozen food items are perishable and must receive proper handling in transit and storage to reduce risk to the health and welfare of personnel who prepare and eat foods. During loading and unloading on docks, piers, or on board, you should keep areas as clean as possible. Long exposure to weather will hasten spoilage. Daily checks on the sanitation of dry, freeze, and chill spaces are essential. Mold and decay go hand in hand with poor housekeeping. Decks, deck gratings, bulkheads, and overheads should be cleaned, sanitized, and aired as often as possible. Cleaning and defrosting of refrigerated spaces should proceed when stocks are low.

Cleaning gear (for example, swabs and brooms) and cleaning supplies (for example, detergents, disinfectants, and other toxic materials) should be stored in areas specifically designated for their purpose. These items should not be stored in food storage cabinets or on food storage shelves.

Dressing Rooms, Lockers, and Toilet Facilities

Street clothes should never be worn in the galley. Adequate, clean, and orderly facilities should be provided for personnel to keep and change clothing to be worn when performing routine duties in foodservice operations. Adequate space should be provided for hanging up these pieces of clothing because they can contaminate food, food equipment, and food preparation surfaces. Dressing rooms or designated areas for changing and storing clothing must be located outside the areas where food is stored, prepared, and served. Dressing rooms and lockers must be clean and orderly at all times.

Conveniently located toilet facilities must be accessible to personnel at all times. These areas must be adequately equipped with proper waste receptacles, toilet paper, and an approved hand-drying device or

sufficient disposable towels. Heads should be located within or immediately adjacent to toilet areas as well as within food preparation areas. These heads must be kept in a clean and orderly appearance. An authorized soap dispensing system and hot and cold running water are also required for use by personnel.

Garbage and Trash Disposal

The method of collection and disposal of garbage may differ on various ships or stations, but the basic requirements are the same. Garbage must be disposed of promptly to prevent contamination of spaces and to eliminate a possible fire hazard.

Garbage and refuse must be kept in leakproof, nonabsorbent containers and a sufficient number should be provided to prevent overfilling. Containers will be emptied as necessary during operations and at the close of each workday. After being emptied, each container should be thoroughly cleaned, inside and outside, in a manner that will not cause contamination of food, equipment, utensils, or food preparation areas. Suitable facilities, including hot water and detergent, should be provided and used for washing the containers.

Ashore galleys and outside refuse and garbage storage areas or enclosures should not be located within 100 feet of the foodservice facility. They should be placed on or above a smooth surface of nonabsorbent material such as concrete or machine-laid asphalt. These surfaces must be kept clean and in good condition.

Food waste disposers or grinders may be used for garbage disposal provided they are designed and/or located in a reamer that prevents contamination of food contact surfaces as a result of a splash and aerosol generation. Potable water should be used as a flushing medium unless otherwise indicated by BUMED.

Insect and Rodent Control

According to BUMED, the term *vector* is used to refer to all insects, rodents, and related animals that are significantly related to the transmission of disease to man, act as intermediate hosts or reservoirs of disease, present problems of sanitary or hygienic significance, or otherwise affect the health and efficiency of personnel.

Programs for controlling vectors are command responsibilities coordinated through public works programs and medical departments. Because the first and most important step in control is to destroy breeding

grounds, basic sanitation measures for which foodservice personnel are responsible must be strictly enforced.

The foodservice facility and its adjacent grounds must be kept clean and free of litter and debris. Openings to the outside should be effectively protected against the entrance of rodents and insects by use of self-closing doors, closed windows, screens, air curtains, or other means. Screens should be tight-fitting, free of breaks or tears, and not less than 16 to 1 mesh. However, screens are not required in air-conditioned foodservice spaces where windows or portholes are sealed closed.

Space Cleanliness

In most foodservice operations, a space inspection is conducted before securing. At most commands the inspection is conducted by the duty supply officer or a senior MS. Areas of concern are sanitation, fire, safety, and security.

Always remember that strict sanitation procedures should be followed in all areas of foodservice operations. Cleanliness can never be overemphasized.

FOOD SERVING AREAS.— All serving lines should be equipped with a functional sneeze shield. It must present a barrier between the oral zone of patrons within the normal range of stature and the food displayed for service.

Proper cleaning and sanitizing procedures for foodservice equipment on the line and around the serving area are equally important in the galley. A number of regulations attendant to serving food must be observed to reduce the possibility of food infection. All pans, serving utensils, and counters must be kept immaculately clean and sanitized.

Self-service salad bars must be carefully supervised to prevent contamination of food items by patrons, thereby preventing the transmissions of pathogenic organisms from one person to another.

FOOD PREPARATION AREAS.— High standards of sanitation and cleanliness must be maintained at all times in these areas. As an MS, you will practice and enforce the “clean as you go” policy for every foodservice person. Cleaning in this way helps maintain high sanitation standards as well as cut down on the cleanup time after the meal and at end of the workday. Wash your hands and equipment first before starting to prepare food items. Contaminated hands or equipment leads to contaminated food. Keep

worktables sanitized and immaculate y clean. Do not use steel wool for cleaning. Smoking is not permitted in any foodservice areas.

RECEIVING AND FOOD STORAGE AREAS.— Before receiving and storing food items, it is very important that loading docks, piers, or areas where foods are received and stored must be thoroughly cleaned to avoid food contamination. Stores must be inspected for the presence of cockroaches and other insect pests before they are stored. Correct storage procedures play a major role in preventing food-borne illnesses and increasing the storage life of food. High levels of sanitation and safety must be maintained in all food storage facilities. Food items should be safely palletized or placed on shelves in an appropriate manner. This proper storage allows proper cleaning and prevents insect and rodent infestation.

DEFENSE AGAINST RADIOLOGICAL, BIOLOGICAL, AND CHEMICAL AGENTS

The nature of the radiological, biological, and chemical contamination problem and the basic procedures to be followed when decontaminating food, galleys, spaces, and equipment are discussed in the following paragraphs.

DEFENSE AGAINST RADIOLOGICAL AGENTS

Radiological defense includes all such measures to minimize personnel and material damage from radioactivity. The basic responsibility for this function resides with the damage control organization of the ship or station. Your basic guidance in radiological defense matters will come from them. Supply department personnel are normally assigned appropriate duties according to the damage control plan. You should be aware of the plans and procedures to be followed on board your ship or station.

Emergency operations are those that immediately follow the blast. During this period, a realistic evaluation of the disaster is made and initial steps toward recovery are taken. Protective clothing monitoring equipment and decontamination gear will also be needed.

RADIOLOGICAL CONTAMINATION

Blast damage and thermal radiation may result in partial or complete destruction of messing facilities and

food items. Radioactivity is important because of the effect it has on the human body. Because of its ability to penetrate matter deeply, gamma radiation is usually considered to be the most hazardous. Since the principal source of alpha particles would be the unfissioned nuclear material of the weapon, the probability of significant alpha contamination from nuclear detonation is small. Beta particles have poor penetrating ability. Ordinary clothing will stop beta particles. They enter the skin only to a depth of about one-fifth of an inch, but their ionizing power is about 100 times that of gamma rays. When ingested with food, inhaled, or admitted into the body through cuts or open wounds, beta particles meet no barriers and become particularly destructive if they are retained in the body for sometime. Therefore, in food preparation and service, all forms of radioactivity should be regarded as hazardous.

Radioactivity may be introduced into exposed materials that are close to the burst. Such items as soap, table salt, copper, or brass may become radioactive as a result of radiation (the action of neutrons). Radioactivity may also be carried by blast residues, the principal one being dust particles. A person contaminated by radioactive materials can easily contaminate an otherwise safe object or area. If the person handles foods, the foods can become contaminated. Radioactivity cannot be destroyed by cooking or sterilization; neither can it be neutralized by chemical treatment. It must be removed as completely as possible to a limit of radioactivity set by the command authority in the light of existing circumstances.

MONITORING TO DETERMINE EXTENT OF RADIOACTIVITY

Radioactive materials can only be removed by physical means. The extent of radioactivity existing in any food preparation or serving area should be determined by a survey with radiac monitoring equipment. This includes the galley utensils, food for preparation, dinnerware, the scullery, and all personnel involved in food preparation and service. If the survey so indicates, it may be necessary to reestablish the mess in another area designated as safe by the commanding officer.

The supply officer is responsible for taking the necessary precautions to make sure the food served is free from radioactive contamination. Galleys and other food preparation spaces, food, equipment, utensils, dinnerware, and personnel engaged in the foodservice operation should be carefully monitored by qualified persons with appropriate monitoring equipment to learn

the presence and the extent of radioactive contamination.

Decontamination operations should be carried out as required. Food items in glass or metal containers or sealed in barrier-wrap packages are the least likely to be contaminated. These should, nevertheless, be monitored, and care should be exercised upon opening such packages to avoid contamination. The fresh water supply should be monitored. Food items should be monitored in their dry state because dilution with water will substantially lower the beta readings and the presence of alpha particles may not even show up on radiac instruments. All food items, when they have been monitored, must be clearly marked as Contaminated or Safe for Use. All food items should be cleared for use after monitoring if found to be within acceptable limits established by the local command according to the *Radiation Health Protection Manual*, NAVMED P-5055.

RADIOLOGICAL DECONTAMINATION

There are various methods of removing contamination. They differ in effectiveness in removing the contaminant, in applicability to given surfaces, and in the rate of operation. These, in general, fall into two classes, gross or rough decontamination and detailed decontamination. Gross decontamination consists of a rapid washing down with large quantities of uncontaminated water from a fire hose or nozzle system. This class is generally not suitable for use in galley and messing areas except for decks. Detailed decontamination procedures are more thorough. These procedures use more time, manpower, and material, but they are also more effective. Detailed decontamination will be necessary in galley and messing areas. Efforts to decontaminate with heavily contaminated water will obviously be ineffective. However, water contaminated to a lesser degree than the surface contamination to be removed may still be used. Water used for decontamination must be allowed to drain freely from contaminated areas. Water from tightly covered storage tanks should be safe and potable, provided the circulating system is tight. Water from open reservoirs cannot be relied upon to be free from contamination. Seawater in the neighborhood of an aerial burst to windward will be contaminated at the surface. A subsurface burst will heavily contaminate seawater in the vicinity. General knowledge of the local situation and a monitor survey should provide data on which a decision regarding the water supply will be based.

When materials (cleaning agents) specifically designed for the removal of radioactive contaminants are available, they should be used according to instructions and the material safety data sheet (MSDS). When they are not available, the following solutions are suggested for the general cleaning of galley surfaces:

Formula 1

Detergent general-purpose, liquid, water-soluble, type I, 1/2 pound. Military specification MIL-D-16791.

Sodium phosphate, tribasic, technical (trisodium phosphate), 1/2 pound. Federal specification O-S-642, type II.

Water, hot, 12 gallons, 100 pounds.

Directions: The sodium phosphate should be completely dissolved by stirring it into hot water. The liquid detergent should be added and stirred until it is thoroughly dispersed.

Formula 2

Dishwashing compound, machine, granular, free flowing. Federal specification P-D-425a (specify whether hard or soft water will be used).

Directions: The compound should be dissolved in hot water to make a 0.5 percent (approximate) solution (1 pound per 25 gallons of water).

The solution should be hot when it is used.

Formula 3

Citric acid, monohydrate, granular form. Military specification MIL-A-11029 (Cml), Change No. 3223.

Directions: Citric acid should be dissolved by stirring to make a 3 percent (approximate) solution (3 pounds per 12 gallons of water). In use, utensils should be immersed and metal surfaces should be sprayed.

Except for citric acid, the previous materials are commonly used and are readily available. The suggested formulas are not intended to take the place of agents specified in existing decontamination instructions. They constitute the bare minimum as substitutes and should serve to meet immediate emergency requirements. All chemical cleaning agents function most efficiently when hot. The choice of method and cleaning agent to be used should depend upon the nature of the surface to be decontaminated, the kind and degree of contamination, and the time, manpower, and materials available to do the work.

All these cleaning agents are hazardous materials. Always wear goggles and protective gloves when

mixing these solutions, and consult the MSDS for specific precautions.

Decontaminating Foods

All food should be carefully monitored. Foods in metal or glass packages may be safe. Contamination is best removed from the external surfaces by washing. Food items in sealed, dustproof packages may also be safe, provided the wrapper is not broken. To remove the contamination from these packages, vacuum them and carefully remove the outer wrap. Some vegetables can also be decontaminated if they are carefully washed, dried, monitored, and peeled-if monitoring shows contamination is not above specified limits. When surface contamination cannot be physically removed, the food should be condemned. All foods must be inspected and approved by the medical officer.

Decontaminating Spaces and Equipment

Thorough cleaning of all surfaces is vital. Work should commence overhead and continue downward in the direction of the liquid flow. When feasible, the first step should consist of flushing the surfaces with safe water. Do not get water on electrical controls that are not waterproofed. The second step involves systematic scrubbing with chemical cleaning agents. Piping, ductwork, stanchions, bulkheads, coamings, and decks should be repeatedly scrubbed until monitoring indicates that a safe condition exists. Bare metal surfaces should be given an initial scrubbing with alkaline detergents to remove grease film. When available, citric acid solution should then be applied and allowed to remain for a minimum period of 10 minutes. Rinse the surface with safe, fresh water, allow to dry, and monitor. In the absence of citric acid, vinegar may be used, but it is less effective.

Decontaminating Utensils and Dinnerware

Treat metal utensils and dinnerware such as metal tableware and cutlery in the same manner as other metal surfaces. Wash with a detergent followed by an acid treatment. When possible, immerse utensils and dinnerware in the acid solution. Crockery and glass present no particular cleaning problem, provided the glazed surfaces are without scratches or foreign deposits such as stains or hard water scale. Plastic ware may present some difficulty because of the relatively porous character of the surface, scratches, and the presence of foreign deposits. Both glassware and plastic ware should be machine washed, rinsed, dried, and each item

monitored. Those that do not pass should be inspected for cracks and surface defects. Cracked and badly scratched items should be disposed of immediately. The other items still showing contamination should be given repeated washings until safe, or they should be segregated to await natural decay of contamination or disposal of the item.

Protection of Personnel

When you are engaged in decontamination, wear protective clothing as prescribed by the ship's damage control bill. If protective clothing is not available, similar garments may be substituted. Care must be taken to make sure substitute clothing adequately prevents radioactive particles from coming in contact with the skin or gaining entry to the body by ingestion, inhalation, or through breaks in the skin. Masks should be worn. In the absence of regulation masks, chemical goggles should be worn to protect the eyes. A high efficiency particulate air (HEPA) filter respirator also can be used to protect the lungs.

Spaces that were not contaminated, or that have been decontaminated, must be carefully protected. All personnel and material must be carefully monitored (decontaminated if needed) before anyone is permitted to enter these spaces. Cleaning gear, items of protective clothing, and so forth, used in decontamination procedures should be segregated and disposed of as contaminated according to their level of contamination.

To familiarize yourself with protective clothing and equipment, and with the procedure for adapting regular issue clothing for NBC warfare protection, see *Military Requirements for Petty Officer Third Class*, NAVEDTRA 12044.

Preventing Recontamination

Contaminated items brought accidentally into spaces should be removed and, pending decontamination of the affected areas, these areas should be roped off. Personnel who may have walked through these areas or who may have otherwise come in contact with radioactive particles should be sent to the decontamination station.

DEFENSE AGAINST BIOLOGICAL AGENTS

The United States has renounced all use of biological agents in warfare, but the need still exists to be prepared to defend ourselves against these agents if

other countries should use them. The following section, therefore, discusses the nature of biological agents and the measures you should use to decontaminate the galley, messing areas, and food storage spaces in the event of enemy biological attack.

A biological agent is defined as a microorganism that either causes disease in man, plants, and animals or causes the deterioration of material.

The chief objective of biological agents is mass infection that results in the incapacitation or death of large numbers of individuals or in the destruction of their sources of food, both animal and plant. The biological agents, unlike most other weapons, act on living matter only and are limited in use to these objectives.

In case of a biological attack there are certain instructions that should be carried out for the protection and decontamination of eating, drinking, and galley utensils; galley and foodservice equipment; and messing areas contaminated by biological agents.

Good sanitary and hygienic practices are the best defense against many aspects of biological warfare. A close examination of the cleanliness of the mess and strict adherence to the applicable instructions will improve biological defense greatly.

The problems of biological agents differ from ordinary military hygiene problems only in that harder types of organisms may be present in other than their normal environment and in higher levels of contamination.

BIOLOGICAL CONTAMINATION

In treating the problem of biological attack, it is assumed that there could be contamination of personnel, of all exposed surfaces, and of circulating air. Because of the current difficulties in rapidly detecting biological agents, knowledge of contamination might (although not necessarily) be based on the occurrence of widespread or unusual sickness. This sickness could be caused by contamination that had occurred several days or weeks before. A situation could exist also whereby extensive use of biological agents would require additional precautions in the operation of all messes. These instructions are intended for use in the event of suspected or known biological attack. The problem is to decontaminate and prevent recontamination.

BIOLOGICAL DECONTAMINATION METHODS

Use calcium hypochlorite (bleach) solutions for biological decontamination. Scrub the interior surfaces of contaminated spaces with 200-ppm chlorine solution to remove dust and grease. Then, hose spaces with fresh, safe water and repeat the process. You may also use iodine solutions prepared by the medical department.

Large equipment (those items too large to be immersed in sinks or run through dishwashing machines) should be washed, rinsed, and decontaminated in the same manner as prescribed for interior surfaces of messes. Small items of equipment that will not suffer damage by immersion should be washed, rinsed, and sanitized in the dishwashing machine or by hand dishwashing as described earlier in this chapter.

Before eating and drinking utensils are brought to the scullery for decontamination, the interior bulkheads, all working surfaces (tables, dish carts, and sinks), the interior and exterior of the dishwashing machine, and all other equipment used in the washing and sanitizing of eating and drinking utensils should be thoroughly washed, rinsed, and decontaminated as appropriate.

Eating and drinking utensils should be decontaminated by machine or hand washing. A person who has handled contaminated utensils should not handle decontaminated utensils until the person has been decontaminated. Decontaminated articles should not be placed in contact with any surface that has been exposed to contamination. If possible, use baskets or containers designed to hold silverware in a vertical position, handles down, during the washing and sanitizing processes, and additional containers of similar construction into which the silverware may be inverted without being handled by workers. If such containers are not available, lay the silverware flat in the racks, not exceeding two utensils, with the handles extending in the same direction. Do not exceed a depth of two utensils. Take care when removing utensils from the racks after decontamination to prevent recontamination.

Sterilization by hypochlorite solution should be used only when dishwashing machines do not operate correctly. The utensils should be soaked, while still in the washrack, for 1 full minute at 100°F to 140°F in a solution of 1 part hypochlorite and 50 parts water in a single-tank machine, or 1 part hypochlorite and 500 parts water in a double-tank machine; one-fifth of 1 percent of a detergent must be added to either solution.

This solution may be mixed from nonionic detergent and any one of several chlorine containing compounds such as calcium hypochlorite, or laundry bleach.

In storage, compounds containing chlorine have been known to deteriorate. It will be necessary, therefore, to have a qualified person from the ship's company analyze the soaking solution for chlorine content to make sure the proper concentration of available chlorine is attained and continued at sufficient strength.

After the sterilization, soak and water rinse, cover the washracks containing the utensils with a cloth that has been sterilized by boiling. Do not transfer utensils to another rack. Make sure personnel in the serving line pick up utensils from the washracks by touching only the handles.

Large equipment may be decontaminated by the use of hypochlorite. Hypochlorite is corrosive to all metals that will rust and should not be allowed to come in contact with motors and other electrical equipment from which hypochlorite could not be thoroughly wiped off. After decontamination, cover as much of the equipment as possible with clean cloths to prevent recontamination.

Avoidance of Recontamination

Recontamination may be caused by secondary aerosols that resettle organisms on surfaces or contaminate the air that is breathed. Secondary aerosols are clouds formed from particles (bacteria or other organisms) that, having been deposited on a surface, are stirred up into the air again by scuffing, shaking, or other mechanical action. Secondary aerosols may be suppressed by wetting surfaces with oil or water. If oil is used as a suppressant, it must not generate harmful vapors and it must not be applied to walking surfaces which may create slippery conditions.

It is important to make sure, before entering the messing area, MS personnel and all personnel eating in the messing areas are as free as possible from contamination. The medical officer should be consulted on the decontamination of foodservice personnel. In cold weather, personnel in the serving line should be required to remove outer garments and leave them outside the messing area before entering the mess. It has been found that removing clothing will shake off organisms that have come in contact with the surfaces, thereby setting up secondary aerosols. Do not permit unauthorized personnel in foodservice spaces.

Hypochlorite is a strong oxidizer and, in powdered form, reacts violently with oils and greases. Use hypochlorite in a well-ventilated area. Always wear goggles and protective gloves, and consult the MSDS for additional precautions.

Decontaminating Food Items

The advice of the medical officer must be sought before any attempt is made to decontaminate food suspected of biological contamination.

Semiperishable Food Items

Food packed in containers that are resistant to the passage of biological agents (sealed containers made of metal, plastic, glass, or porcelain) requires only proper exterior decontamination be performed. Paper labels and paper covers must be removed from the container and one of the following methods of decontamination should be used:

1. Immerse the containers for 15 minutes in a solution of water to which 200-ppm available chlorine has been added and then rinse them with potable water.
2. Soak the containers for a minimum of 15 minutes in effective detergent solution as a quick method to reduce contamination to a safe level (see formula 1 discussed under the heading Radiological Decontamination); then rinse them with potable water.
3. The exterior surfaces of stacks of food packed in impermeable packages can be sterilized using any of the standard chemical methods such as bleach solution, sodium carbonate, or DS2 followed by rinsing in potable water.

Food packages that will not stand immersion must be wiped off with a solution of water to which 200-ppm available chlorine has been added and the food thoroughly cooked before it is eaten.

Fresh or Chill Items

Food that can be peeled or pared may be decontaminated by soaking for 15 minutes in water to which 200-ppm available chlorine has been added before it is peeled. The food must then be thoroughly rinsed in potable water. It can then be peeled or pared and should be rinsed again with potable water. This method has been applied satisfactorily to apples, potatoes, and eggs.

For other fresh or chill items, the use of heat is the most practical means of decontaminating foods.

Thorough cooking will reduce contamination to a safe level so that food can be consumed.

Frozen Items

Food items stored in the freeze space in impermeable containers (tamed frozen strawberries, for example) may be decontaminated by immersing the containers for 15 minutes in a solution of water to which 200-ppm available chlorine has been added; the containers are then rinsed with potable water.

Food items stored in the freeze space in permeable containers (frozen vegetables, for example) may be decontaminated as outlined earlier for food packaged in sacks or other permeable containers.

Food items stored in the freeze space, but not contained in outer packaging (meat, for example), must be completely thawed and thoroughly cooked before they are eaten.

Additional Precautions

Hands should be free of contamination during the opening operations to make sure the contents are not contaminated. Opened cans of fruit jam, jelly, or similar foods must be destroyed. Opened cans of vegetables may be decontaminated by boiling the vegetables for a minimum of 15 minutes in a steam-jacketed kettle.

Biological Decontamination in Food Preparation

The use of heat is the most practical means of decontaminating biologically contaminated foods. In no case should decontaminated food be consumed until it is pronounced safe by a medical officer. It is recommended that, insofar as possible, only foods contained in impermeable packages (cans, bottles, jars) be decontaminated and used for meal preparation.

Food items that are not packaged or that are packaged in permeable containers may be cooked by either cooking in a pressure-type cooker at 15 pounds of pressure at 250°F (or 121°C) for 15 minutes or boiling for a minimum of 15 minutes.

Certain contaminated items may be decontaminated by baking. Only those recipes listed in the *Armed Forces Recipe Service* (AFRS) that specify an oven temperature of 400°F and above, for a cooking period of 30 minutes or longer, should be used to prepare baked items from contaminated ingredients.

All meats except those contained in decontaminated impermeable containers (canned meat items) must be cooked to the well-done stage. Guidance cards in the AFRS include information on internal temperatures indicating the well-done state.

Biological Decontamination of Water

The detection of water contamination and requisite laboratory analysis are responsibilities of the medical department. Biological decontamination of water is not difficult when regular water treatment facilities exist. However, more chlorine probably will need to be added during the ordinary processing of the water. If no water treatment facilities are available, water can be decontaminated by any of the following methods:

1. By boiling for 20 minutes
2. By using iodine tablets coupled with boiling

A medical officer should approve the method of decontaminating; after the decontamination process, the officer should determine whether or not the water is fit to be used. Water that has been decontaminated must be protected against further contamination.

DEFENSE AGAINST CHEMICAL AGENTS

The United States has committed itself against initiating the use of chemical agents. However, it is necessary to be prepared against attack by an enemy using this type of warfare.

A chemical agent is defined as a solid, liquid, or gas that, through its chemical properties, produces lethal or damaging effects on man, animals, plants, or material, or produces a screening or signaling smoke.

Chemical warfare agents, like the biological warfare agents, are used mainly because of their effect on personnel, although some agents will have a corrosive effect on specific materials, and incendiary devices will burn most materials. These agents produce a harmful physiological reaction when applied to the body externally, inhaled, or ingested. Most chemical agents cause disorganization of the functioning of the body.

The degree of contamination of the messing area and equipment depends on the chemical agent used and the factors involved, such as the method of delivery (vapor, light liquid, and heavy liquid), the weather, and the various strengths of contamination.

The following paragraphs prescribe the methods to be used in decontaminating eating, drinking, and galley utensils; galley and foodservice equipment; and messing areas that are contaminated by chemical agents.

Vapor Contamination

After the surrounding areas have been decontaminated, the entire general mess should be aerated thoroughly and the entire area washed down inside and out with safe water. All equipment and utensils used in the preparation and service of food should be washed carefully using normal procedures. Spaces, utensils, and equipment should then be tested with the chemical agent detector kit and, if necessary, any of the prescribed procedures should be repeated.

Light Liquid Contamination

The messing area inside and out should be washed with hot water. You may add an alkaline detergent, such as a standard general-purpose detergent, and if applied at high pressure, it will increase the water's effectiveness. As an alternative method, for mustard gas, you may apply a bleach solution to all surfaces. After washing down, aerate the entire area. If slight contamination remains, the area should be heated to as high a temperature as possible for about 1 to 2 hours. Then the spaces should be opened and ventilated for 15 minutes. Repeat the procedure as necessary, testing at intervals with a chemical agent detector kit. Porous objects, such as meat blocks and wooden benches, may absorb liquid contamination to the extent that they will have to be destroyed. Metal, glass, or china utensils or any equipment that is not damaged by water should be immersed for 30 minutes in actively boiling water. Add 1 cupful of alkaline detergent to each 5 gallons of water. Upon completion of the boiling process, you should follow normal dishwashing procedures. Plastics generally cannot withstand boiling water and should be destroyed.

Heavy Contamination of Liquid

Heavy contamination of liquid is unlikely, except from a direct hit, in which case recovery of the space

and contents will be a major undertaking. However, when such is the case, the following procedures are recommended.

Space should be roped off or abandoned as unsalvageable, as no amount of washing or scrubbing of a porous surface that is heavily contaminated by a liquid chemical agent (particularly mustard gas) is likely to do much good.

Metal, glass, or china utensils or any equipment that is not damaged by water should be decontaminated in the same manner as prescribed for light contamination of liquid discussed earlier.

Large equipment unsuited for immersion in boiling water should be scrubbed vigorously with DS2 solution or hot water and an alkaline detergent, rinsed, disassembled, and scrubbed again paying particular attention to any parts not reached in the assembled state that are reachable in the disassembled state. Then, the equipment should be rinsed, dried, oiled, greased, and reassembled. Wooden items should be removed and destroyed.

On electrical equipment, unless the electrical unit is enclosed in a watertight seal, water must not be used in the decontamination process. Electrical equipment should be cleaned with trichloroethane or DS2 solution. All greases must be removed, bearings cleaned, and the equipment regressed.

Trichloroethane and DS2 are toxic chemicals. Protective clothing and respirators should be worn when they are used, and the MSDSs should be consulted for additional precautions.

Careful inspection must be made of the general situation before large quantities of food or water suspected of chemical agent contamination are destroyed. Contaminated food and water must be destroyed in some cases; in other cases, they may be salvaged by special decontamination procedures. In any event, the responsibility belongs to the medical department to determine whether food or water contaminated by chemical agents should be decontaminated or destroyed.

CHAPTER 2

RECEIPT, INSPECTION, EXPENDITURE, AND STORAGE OF FOOD ITEMS

As a Mess Management Specialist (MS), you may be assigned as the jack-of-the-dust or as the subsistence bulk storeroom storekeeper, responsible for the proper receipt and storage of food items and making breakouts to the general mess, officers' mess, and chief petty officers' mess. It is also your responsibility to keep these spaces clean, safe, and orderly and to keep the leading MS up to date on stock levels.

This chapter discusses the procedures for the receipt, inspection, storage, and expenditure of food items as prescribed by the *Food Service Management*, NAVSUP P-486.

RECEIPT

Deliveries can usually be anticipated because of shipment notices, delivery dates on requisitions, or other notifications, and preparations should consequently be made to receive the material. Receiving personnel should be ready to inspect the material, storerooms should be ready to receive the material, and the necessary arrangements for working parties should be made well in advance so that once the anticipated material arrives, it may be stored immediately to prevent temperature fluctuations. Such fluctuations will reduce the quality and storage life of food items.

Subsistence items received aboard a ship or shore activity are accompanied by a variety of receipt documents depending upon the method of request and the issuing activity. Certain certifications are common to all receipt documents. Receiving personnel must do the following:

- Inventory all food items
- Circle the quantity accepted
- Date the document upon receipt
- Have items inspected by a medical representative
- Have the documents stamped by a medical representative as passing medical inspection
- Sign the document to indicate receipt

UNLOAD SHIPMENT

Always remember that safety, sanitation, and security of food items should not be compromised when unloading and loading stores. Careful planning and preparation will minimize, if not prevent, this problem. Receiving procedures will be issued and routes established. This will facilitate unloading and loading stores and definitely eliminate wandering food items that could be lost or stolen.

Working parties should be requested well in advance and requirements are established from each department. Get the request for working parties and requirement lists including the day of delivery published in the plan of the day a few days before the day of delivery. When there is a sufficient number of personnel from other departments, use supply personnel as checkers, spotters, and supervisors to the greatest extent possible.

Unload and load as fast as possible to avoid prolonged exposure to less than ideal temperatures and to not diminish the average shelf life of food items and to prevent spoilage.

Safety

All personnel involved in receiving and storing food items must receive instructions on the following safety precautions:

- The proper method of lifting heavy objects
- Wearing of protective hats, safety shoes, and gloves
- Operation of materials-handling equipment such as forklifts, pallet jacks, and portable conveyors
- Removal of hatch covers and ladders

Designated Receiver

When food items are received, the food service officer (FSO) or a designated assistant inspects the food items to verify the exact quantity received and signs the receiving documents to acknowledge receipt.

Custody

The bulk storeroom storekeeper having custody of the food items delivered accepts responsibility by signing a statement on the invoice that normally reads, "I accept responsibility for these items and hold myself accountable to the United States Government."

Date Stamping

Food items must be date-stamped or color-coded to make sure the oldest stock is used first.

INSPECTION

Regardless of the source from which food items are obtained and regardless of any prior inspection, it may be your responsibility to inspect them as they arrive to determine that the specified quantities have been received.

A designated member of the medical department should perform a fitness-for-human-consumption inspection upon receipt of food items that have been purchased from a local market or under contracts that require inspection at destination. The receipt document showing that this inspection has been done must be signed by the medical representative.

Inspection of Food Items Received From Naval Sources and Other Government Agencies

An ashore supply activity will perform a quality inspection of food items upon acceptance from the original supplier. This inspection should be done according to NAVSUPINST 4355.4 and should make sure the food items conform to the specifications included in the purchase document. Such inspection will not be duplicated aboard ship. Before storing, the receiving individual will coordinate inspection procedures to detect any deterioration, contamination, or infestation that may have occurred since the quality inspection at the supply activity. Contaminated or infested foods received via underway replenishment should be immediately separated and disposed of according to the NAVSUP P-486. Government-owned subsistence items received in usable condition but unfit for storage should be used promptly and any loss surveyed.

Inspection of Food Items Received From Commercial Sources

Subsistence items received from commercial vendors will be inspected at origin and destination for conformance to all terms and conditions quoted or referred to in the contract or purchase order. However, inspection at origin may be waived if lack of time or other justifying circumstances exist. The supply officer will make sure the commercial vendor has certified that the food items delivered are in conformance with the requirements of the Federal Food, Drug, and Cosmetic Act. Meat, poultry, fish, and their by-products delivered under contract within the United States will be accepted only if they bear the appropriate stamps from the respective government agencies. In addition they should also have the special Department of Defense stamp. These various stamps are illustrated in figure 2-1.

Inspection by the Medical Department

A designated representative of the medical department will perform a fitness-for-human-consumption inspection upon receipt of food items that have been purchased on the local market or under contracts that require inspection at destination. The receipt document showing that a fitness-for-human-consumption inspection has been performed should be signed by the medical representative. Suspected items in which there is doubt as to fitness are not accepted and are referred to a local Army veterinarian or environmental preventive medicine unit (EPMU) for analysis.

Unsatisfactory Food Items

The subsistence supply system has quality assurance provisions designed to guarantee the receipt of wholesome, satisfactory food products. However, the system does experience breakdowns in specification standards is allowing some unsatisfactory products to filter into the supply pipeline.

NONHAZARDOUS.— These food items do not meet expected or desired standards, but do not constitute a health hazard to personnel if consumed. A good example of this would be chicken wings in a box labeled breasts.

HAZARDOUS.— These food items would possibly cause, or are suspected to have already caused, harm after being consumed. Determination of fitness for human consumption is the responsibility of the

DEPARTMENT OF AGRICULTURE
INSPECTION STAMPS

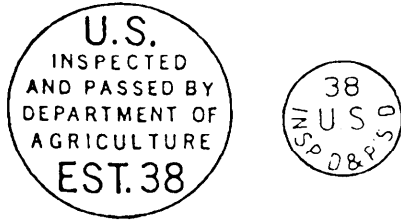

MEAT

DEPARTMENT OF DEFENSE
INSPECTION STAMPS

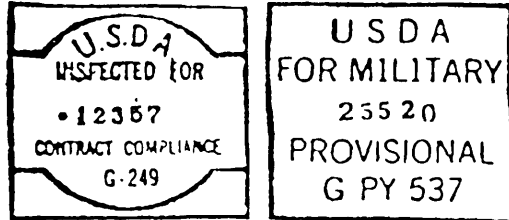

POULTRY

DEPARTMENT OF COMMERCE
INSPECTION STAMPS

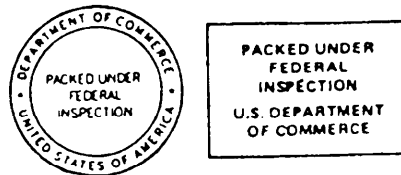

FISH

Figure 2-1.—Meat, poultry, fish, and their by-products inspection stamps.

medical officer. Examples of hazardous food item characteristics are widespread presence of swollen or leaking cans and products with either offensive or unusual odors and colors or any other evidence of deterioration.

Refer to the NAVSUP P-486, volume I, for more information regarding the reporting and handling of nonhazardous and hazardous food items.

Discrepancies in Shipment

It is always possible that several discrepancies can occur during shipment and receipt. All of these can be discovered during careful inspection and verification of receipts. The following actions will be taken when these discrepancies are found.

SHORTAGES IN SHIPMENT.— A shortage occurs when the quantity received is less than the quantity shown on the receipt, regardless of the quantity on the original requisition. If a shortage exists, contact the issuer or shipper, either in person or by message, to try to resolve the discrepancy. Refer to NAVSUPINST 4440.179 for further guidance. Shortages due to transportation discrepancies will be reported according to NAVSUPINST 4610.33. Receiving activities will notify the supply/transportation officer of all transportation discrepancies upon their discovery. For all types of discrepancies, the receipt inspector and the bulk storeroom custodian will indicate on the receipt

document the actual quantity physically received by drawing a single line through the invoice quantity and recording and circling the actual quantity. Both will then sign and date the receipt documents. (See figs. 2-2 and 2-3.) Forward the documents to the FSO.

When substantial shortages are found in shipments received from Navy supply activities (Navy supply centers [NSCs] or Navy supply depots [NSDs]) or combat logistics force ships (AFSs, AFs or AORs), you should immediately contact the issuer/shipper in person or by message to resolve the discrepancies. In the event shortages do exist after investigation, the full quantity and dollar value of the invoice will be posted to the Subsistence Ledger, NAVSUP Form 335; the Record of Receipts and Expenditures, NAVSUP Form 367; and the Requisition Log, NAVSUP Form 1336. The quantity and dollar value of the loss of \$50 or more per line item will also be posted to the records according to the survey procedures found in the NAVSUP P-486, volume I. Losses of less than \$50 per line item will be documented as a loss without survey.

OVERAGES IN SHIPMENT.— An overage occurs when the quantity physically received exceeds the quantity stated on the receipt document regardless of the quantity on the original requisition or purchase order. When this occurs, immediate liaison is to be established with the issuer to resolve the discrepancies.

DOC IDENT	FROM	FSC	STOCK NUMBER	ADD	QUANTITY	DOCUMENT NUMBER	SUPPLEMENTARY ADDRESS	UNIT PRICE	DEL DATE	MARK FOR PROJECT	UNIT PRICE																				
AQA NDZ 3			890501053190	LB	20250	05504 33649031	BDPTM APZ 9M EPS 12011				67																				
SHIPPED FROM		SHIP TO		MARK FOR PROJECT		TOTAL PRICE																									
00244 NSC SAN DIEGO CA		05504 USS DUARTE DD-901				167.50																									
A	WAREHOUSE LOCATION	B	TYPE OF CARGO	C	UNIT WEIGHT	D	UNIT CUBE	E	U F C	F	N M F C	G	FREIGHT RATE	H	DOCUMENT DATE	I	HAT COND	J	QUANTITY	K		L		M		N	O	P	Q	R	S
SUBSTITUTE DATA (ITE)		CLASSIFICATION NOMENCLATURE		ITEM NOMENCLATURE		RECEIVED BY AND DATE		INSPECTED BY AND DATE		REMARKS		SIGNATURE		DATE		RATE		DATE		NAME		DATE		RATE		DATE		NAME		DATE	
13 TRANSPORTATION CHARGEABLE TO		14 BLADING, AWB, OR RECEIVER'S SIGNATURE (AND DATE)		15 RECEIVER'S DOCUMENT NUMBER		16 RECEIVED BY AND DATE		17 INSPECTED BY AND DATE		18 REMARKS		19 SIGNATURE		20 DATE		21 RATE		22 DATE		23 NAME		24 DATE		25 RATE		26 DATE		27 NAME		28 DATE	

DD FORM 1348-1
S/N 0102-U-013-1040
UNTIL EXHAUSTED

64 MAY BE USED

DOD SINGLE LINE ITEM RELEASE/RECEIPT DOCUMENT

Figure 2-2.—Receipt by bulk storeroom custodian using DD Form 1348-1.

DOC IDENT	FROM	FSC	STOCK NUMBER	ADD	QUANTITY	DOCUMENT NUMBER	SUPPLEMENTARY ADDRESS	UNIT PRICE	DEL DATE	MARK FOR PROJECT	UNIT PRICE																				
AQA NDZ 3			890501053190	LB	200	05504 33649031	BDPTM APZ 9M EPS 12011				67																				
SHIPPED FROM		SHIP TO		MARK FOR PROJECT		TOTAL PRICE																									
00244 NSC SAN DIEGO CA		05504 USS DUARTE DD-901				134.00 167.50																									
A	WAREHOUSE LOCATION	B	TYPE OF CARGO	C	UNIT WEIGHT	D	UNIT CUBE	E	U F C	F	N M F C	G	FREIGHT RATE	H	DOCUMENT DATE	I	HAT COND	J	QUANTITY	K		L		M		N	O	P	Q	R	S
SUBSTITUTE DATA (ITE)		CLASSIFICATION NOMENCLATURE		ITEM NOMENCLATURE		RECEIVED BY AND DATE		INSPECTED BY AND DATE		REMARKS		SIGNATURE		DATE		RATE		DATE		NAME		DATE		RATE		DATE		NAME		DATE	
13 TRANSPORTATION CHARGEABLE TO		14 BLADING, AWB, OR RECEIVER'S SIGNATURE (AND DATE)		15 RECEIVER'S DOCUMENT NUMBER		16 RECEIVED BY AND DATE		17 INSPECTED BY AND DATE		18 REMARKS		19 SIGNATURE		20 DATE		21 RATE		22 DATE		23 NAME		24 DATE		25 RATE		26 DATE		27 NAME		28 DATE	

DD FORM 1348-1
S/N 0102-U-013-1040
1 MAR 74 EDITION OF 1 JAN 64 MAY BE USED
UNTIL EXHAUSTED

DOD SINGLE LINE ITEM RELEASE/RECEIPT DOCUMENT

Figure 2-3.—Receipt by receipt inspector-shortage in shipment using DD Form 1348-1.

Overages From a Navy Source.— When discrepancies from a Navy source are not resolved, the receipt inspector and bulk storeroom storekeeper should indicate the actual quantity physically received on the receipt document by drawing a single line through the invoiced quantity. Then both sign and date the receipt document. See figure 2-4. Forward this document to the FSO. A dummy receipt document should then be

prepared to document the excess quantity received. This dummy receipt document can be a DOD Single Line Item Release/Receipt Document, DD Form 1348-1, or a Requisition and Invoice Shipping Document, DD Form 1149. See figures 2-5 and 2-6 for examples of these documents. In addition, mark on the document Dummy Invoice to Cover Excess Shipment to distinguish the dummy invoice from a normal receipt.

DD FORM 1348-1, 1 MAR 74 EDITION OF 1 JAN 64 MAY BE USED UNTIL EXHAUSTED

DD SINGLE LINE ITEM RELEASE/RECEIPT DOCUMENT

Figure 2-4.—Original invoice to cover excess shipment receipt by bulk storeroom storekeeper using DD Form 1348-1.

DD FORM 1348-1, 1 MAR 74 EDITION OF 1 JAN 64 MAY BE USED UNTIL EXHAUSTED

DD SINGLE LINE ITEM RELEASE/RECEIPT DOCUMENT

Figure 2-5.—Dummy invoice to cover excess shipment using DD Form 1348-1.

U.S. GOVERNMENT PRINTING OFFICE: 1982-762-322

SHIPMENT CONFIDENTIAL

1 2 3 4 5 6 7 8 9 10 11 12 13 14 15 16 17 18 19 20 21 22 23 24 25 26 27 28 29 30 31 32 33 34 35 36 37 38 39 40 41 42 43 44 45 46 47 48 49 50

REQUISITION AND INVOICE/SHIPPING DOCUMENT

1. FROM: R05504 USS DUARTE (DD 901)

2. TO: H00244 NSC, SAN DIEGO, CA

3. DATE OF ISSUE: 30 DEC 93

4. ISSUE DATE: 11 JAN 94

5. AUTHORITY OF ISSUE: NAVSUP PUB 486, PARA 6207

6. SHIPMENT ORIGIN: P. T. BOAT, LT, SC, USN

7. DUMMY INVOICE TO COVER EXCESS SHIPMENT

8. QUANTITY AND UNIT: 1721804.2270 (000) 00031 (0) 068732 (2D)

9. PROJECT CODE: 003364

10. COST CODE: 0R0550473170

LINE NO.	FEDERAL STOCK NUMBER	DESCRIPTION AND CODING OF MATERIAL AND/OR SERVICES	QUANTITY	UNIT	UNIT PRICE	TOTAL DOLLARS
1	BEEF, PATTIE MIX Q31 8905-01-050-3190		50		.67	33.50
TOTAL						

NOTE: Item received during replenishment from NSC on 11 JAN 94, DUARTE Doc. R05504-1364-9Q31 applies. Copy forwarded to issuing activity.

RECORDSKEEPER SIGNS AND DATES TO INDICATE RECEIPT OF OVERSHIPMENT

PREPARED BY: *MSA R. Cordeiro*

DATE: 1/11/94

DD FORM 1149 (9-82)

ORIGINAL

Figure 2-6.—Dummy invoice to cover excess shipment using DD Form 1149.

It will also be used as the source document for posting the excess receipt. After the preparation of the dummy invoice document, the receipt inspector and bulk storeroom storekeeper will circle the excess quantity received, then both will sign and date the document. Forward the documents to the FSO.

Overages From a Commercial Source.— When an overage occurs from a commercial vendor, the receipt inspector and bulk storeroom custodian will sign only for the requested quantities on the receipt documents and forward the documents to the FSO. Any excess quantities will be returned to the vendor.

RECEIPTS WITHOUT INVOICES.— When food items are received without invoices or unpriced invoices, a dummy invoice will be prepared and the food items will be taken up at the last receipt price as shown on your current NAVSUP Form 335. When the price invoice is received, the receipt unit price rounded off to the nearest cent will be the unit price for the item. A cross-reference will be made on the priced invoice to its

related dummy invoice and, if required, an additional line entry will be posted on the NAVSUP Form 367 for any difference.

ERRONEOUS INVOICES.— An erroneous invoice is an invoice where the invoice quantity times the unit price does not equal the total dollar value.

Erroneous Invoice From a Navy Source.— When an invoice is received containing an error of \$5 or more, a corrected or credit invoice will be requested from the issuing activity. The error is lined through on the original receipt document (fig. 2-7), without erasing the erroneous figure and the correct amount will be inserted and posted to the NAVSUP Form 1336 and the NAVSUP Form 367. Upon receipt, the corrected or credit invoice will be filed with the retained records. Errors of less than \$50 will be posted as is to the NAVSUP Form 1336 and the NAVSUP Form 367. The difference will be absorbed in the price adjustment at the end of the accounting period.

SHIP TO	SHIP TO	MARK FOR PROJECT	TOTAL PRICE DOLLARS CTS
00244 NSC SAN DIEGO CA	05504 USS DUARTE DD-901		175 50 167 50
WAREHOUSE LOCATION	TYPE OF UNIT	UNIT WEIGHT	UNIT
SUBSTITUTE DATA	MENCLATURE	FREIGHT RATE	DOCUMENT CODE
REMARKS	RECEIVED BY AND DATE	INSPECTED BY AND DATE	WAREHOUSE LOCATION
CORRECTED INVOICE REQUESTED FROM NSC SAN DIEGO ON 11 JANUARY 1994	7752 J M Inspector 1/11/94		

Figure 2-7.-DD Form 1348-1, an erroneous invoice.

Erroneous Invoice From Commercial Sources.— When an invoice is received containing an error of any dollar value, a corrected invoice should be requested from the commercial vendor. The error will be lined through without erasing the erroneous figure and the correct amount will be inserted and posted to the NAVSUP Form 1336 and the NAVSUP Form 367. Upon receipt, the corrected invoice will be filed with retained returns.

Posting Receipts

When you are posting receipts, there are two pieces of information that must be transcribed to general mess records. They are the quantity received and the value of the receipt. Receipts are posted to the Record of Receipts and Expenditures, NAVSUP Form 367; the Subsistence Ledger, NAVSUP Form 335; the Stock Tally Card, NAVSUP Form 209; and the Requisition Log, NAVSUP Form 1336.

The total money value of each receipt document is posted to the NAVSUP Form 367. The first entry is always the inventory value carried forward from the previous quarter. Next, each receipt document is posted to the applicable page of the NAVSUP Form 335. A

separate page of the NAVSUP Form 335 is prepared for each item carried in stock.

One difference you should notice is the unit price. Stock food items have two unit prices, the fixed price and the last receipt price. Since the purchase price for food items on the commercial market fluctuates and the general mess (GM) must operate on a fixed ration allowance, the Navy Food Service Systems Office (NAVFSSO) establishes a fixed price for most items that are used in the GM. Thus, the same charge is made throughout the accounting period for an item with a fixed price regardless of the current market or last receipt price. On the other hand, the last receipt price and the date an item is received are entered in the spaces provided to allow this price to be used to survey, transfer, or sell items to private messes. Also, this price is used to charge out items that do not have fixed prices to the GM and to extend the inventory value.

The use of the Stock Tally Card, NAVSUP Form 209, is optional but strongly recommended. If the cards are used, both the bulk storeroom storekeeper and the jack-of-the-dust should maintain separate sets. When both the issue and bulk storerooms are under the custody of the same storekeeper, only one set of stock tally cards needs to be maintained to show the total stock on hand

SUBSISTENCE LEDGER (4442)

HIGH LIMIT		120		8915-00-582-4060		D76 TOMATOES, #10 CN		LOW LIMIT		40		UNIT OF ISSUE		CN	
MO	DAY	RECEIPTS	EXPENDITURES			ON HAND	MO	DAY	RECEIPTS	EXPENDITURES			ON HAND		
			ISSUED	CUM TOTAL	OTHER					ISSUED	CUM TOTAL	OTHER			
	1	1	B.F.			108									
	1	3		12	12	96									
	1	5	W.R.			94									
	1	9		10	22	84									
	1	12	CPO			72									
	1	20		14	36	58									
	1	27	36			90									
1/1	1.78	2	5	12	48	78									
4/1	1.78	2	11	12	60	66									
		2	15	CO		62									
		2	17		14	74									
		2	23	36		84									
		2	29		6	80									
		3	3		12	92									
		3	7		6	98									
		3	10	W.R.		92									
		3	11	CPO		36									
12/27	1.74	3	15		6	104									
1/27	1.75	3	21	90		120									
3/21	1.77	3	25		18	122									
		3	26			98									
		3	28		8	130									
		3	29	SURVEY		78									
		3	31	INVADJ +12	12	142									
		3	31	162	142	62									
		4	1	B.F.		108									

SALE AT \$1.74 PER CAN

TRANSFER AT \$1.74 PER CAN

SALE AT \$1.75 PER CAN

SALE AT \$1.75 PER CAN

FOOD SERVICE OFFICER WILL INVESTIGATE AND RECONCILE, IF POSSIBLE, DIFFERENCES IN EXCESS OF 5% OF THE TOTAL EXPENDITURES (142 + 62 = 204). THE FOOD SERVICE OFFICER WILL ALSO INITIAL ALL ADJUSTMENT ENTRIES IN EXCESS OF 5% OF THE TOTAL EXPENDITURES.

SALE AT \$1.77 PER CAN

SURVEY AT \$1.77 PER CAN

ISSUES TO THE GENERAL MESS AT \$1.78 PER CAN (WHEN NO FIXED PRICE IS ESTABLISHED, USE THE LAST RECEIPT PRICE (\$1.77))

TOTAL QUANTITY POSTED TO NAVSUP FORM 1059 AND EXTENDED AT THE END OF THE ACCOUNTING PERIOD

AS AN ADDED CHECK TO DETERMINE THE ACCURACY OF THE DATA ON THIS FORM, INSERT A TOTAL LINE AND TAKE THE INVENTORY B.F. (1) FIGURE AND ADD THE TOTAL RECEIPTS (2) AND FROM THIS SUM SUBTRACT THE "CUM TOTAL" (3) AND OTHER (4) FIGURES WITH THE RESULT EQUALING THE ENDING INVENTORY (5) (108 + 162 = 270 - 142 = 128 - 62 = 66)

INFORMATION IS TYPED ON THIS ILLUSTRATION ONLY FOR LEGIBLE PRINTING PURPOSES

Figure 2-8.—Subsistence Ledger, NAVSUP Form 335.

in both the issue and bulk storerooms. Refer to figures 2-8, 2-9, and 2-10 for the preparation and posting of receipts.

Distribution of Receipt Documents From Naval Supply Activities

The DOD Single Line Item Requisition System Document, DD Form 1348; the DOD Single Line Item Release/Receipt Document, DD Form 1348-1; or the

local receipt document required by the supplying activity is used for the receipt document except during underway replenishment. During such replenishment, receipt is documented by the DD Form 1149. At least three copies of a receipt document are received. The copies are distributed as follows:

- Original, signed by the inspector acknowledging that receipts were inspected for quantity and condition and filed in the FSO's accountability file.

REQUISITION LOG (4430) NAVSUP FORM 1336 (8-69)					(REGULAR PROCEDURE)				MONTH AND YEAR January 1994	
DOCUMENT		ITEM	SOURCE	DATE RECEIVED	RECEIPT WITHOUT CHARGE	CUMULATIVE TOTAL	RECEIPT WITH CHARGE	CUMULATIVE TOTAL		
DATE	SERIAL									
3364	9Q31	(B/F) Beef, Ground	NSC NORVA	1/5			61.60			
	Q58	Chicken, Cut-up	"	"			37.80			
	Q84	Fish Portions	"	"			78.00			
	Q95	Frankfurters	"	"			37.20	214.80		
4006	9B28	Beans, Green #10	NSC NORVA	1/9			8.28			
	B80	Carrots, #10	"	"			8.64	231.52		
4021	9C04	Corn, Whole, #303	AS-11	1/22	6.00					
	C26	Fruit Cocktail, #10	"	"	13.86					
	C71	Mushrooms, 8oz	"	"	21.84					
	D20	Pimientos, #25	"	"	17.44					
	D76	Tomatoes, #10	"	"	9.06	88.20				
4023	9K44	Potato Chips, 8oz	NLON	1/24			48.00	279.52		
4026	9V69	Lettuce, Ind, Pk	ABCPRODUCE	NIS						
4027	9W41	Tomatoes, #10	NLON	1/30			9.00			
	W62	Bread, Rye	"	"			9.80	298.32		
4030	9W92	Rolls, Hamb	AS-11	1/31	8.40	96.60				
Total for January 1989							96.60	298.32		

LINE ITEM LISTING OF EACH ITEM ON THE SAME REQUISITION/PURCHASE DOCUMENT

SUM OF 3 MONTHLY TOTALS WILL EQUAL "RECEIPTS WITHOUT CHARGE" ON QUARTERLY NAVSUP FORM 1358

UNFILLED REQUISITIONS RECEIVED AFTER MONTHLY CLOSEOUT WILL BE LISTED ON THE SUBSEQUENT MONTH LOG UPON RECEIPT OF MATERIAL

MONTHLY TOTAL ENTERED ON NAVSUP FORM 1357 "RECEIPTS WITH CHARGE". SUM OF 3 MONTHLY TOTALS WILL EQUAL "RECEIPTS WITH CHARGE" ON QUARTERLY NAVSUP FORM 1358

INFORMATION IS TYPED ON THIS ILLUSTRATION ONLY FOR LEGIBLE PRINTING PURPOSES

17N 0108 305-0400

Figure 2-9.—Requisition Log, NAVSUP Form 1336.

ACTIVITY _____ UIC _____																				
RECORD OF RECEIPTS AND EXPENDITURES (4442)																				
RECEIPTS					EXPENDITURES															
*19 94		SOURCE	DOCUMENT NO		VALUE		*19 94		ACTIVITY/PURPOSE	DOCUMENT NO		VALUE								
MO	DAY		MO	DAY	MO	DAY	MO	DAY		MO	DAY	MO	DAY							
1	1	INV B.F.				11	257	69	1	8	USS ALBANY	03623	3008	9Q31			61	60		
1	5	NSC NORVA	3364	9Q31	9Q95		214	60	1	31	W/R MESS							35	87	
1	9	NSC NORVA	4006	9B28	9B80		16	92	1	31	USS TREPANG	05155	3029	9Q37			157	35		
1	22	USS FULTON	4021	9C04	9D74		88	20	2	10	SURVEY			3041	9692			102	00	
1	24	SUBASE NILON	4023	9K44								05155	3044	9Q40				674	00	
1	30	SUBASE NILON	4027	9W41	9W62									3046	9R81			150	75	
1	31	USS FULTON	4030	9W92														251	36	
2	16	NAVSTA GTMO	4044	9Q34	9U69		7	199	69	3	18	SURVEY						184	80	
2	18	NAVSTA GTMO	4046	9Q10	9U69		1	156	21	3	21	USS TREPANG	05155	3081				20	88	
3	5	NSC NORVA	4062	9A02	9P84		15	321	15	3	31	W/R MESS						392	31	
3	19	NSC NORVA	4074	9C06	9P28		8	736	68	3	31	SPECIAL MEALS						72	64	
3	30	NAVSTA MAYPORT	4088	9Q17	9U15		12	963	33	3	31	EXP W/O SURVEY			3091	9V11		106	70	
3	31	FOREMOST DAIRY	4088	9U34	9U86		1	747	82	3	31	ISSUES TO GM						39	231	49
3	31	TOTAL					58	977	39	3	31	INV						16	342	15
												POST UIC OF OTHER ACTIVITIES						57	783	80
												PRICE ADJ						+1	193	59
												TOTAL						58	977	39

Figure 2-10.—Preparation of Record of Receipts and Expenditures NAVSUP Form 367.

- One copy, signed by the storeroom storekeeper acknowledging responsibility for the items received and filed in the FSO's accountability file.
- One copy, extended, to one of two files; receipts with charge or receipts without charge. This copy is used by the records keeper to post to the NAVSUP Form 335, the NAVSUP Form 367, and the NAVSUP Form 1336, and then filed in the appropriate receipts file.
- All remaining copies are attached to the outstanding requisition copy taken from the outstanding requisition file.

Distribution of Receipt Documents From Commercial Sources

Receipts from purchase and indefinite delivery-type contracts are handled in much the same manner as receipts from Navy activities. When an order is placed, one copy of the Order for Supplies or Services/Request

for Quotation, DD Form 1155, will be given to the storeroom storekeeper for the incoming material file. Upon receipt of the material, the inspector will remove all copies (minimum of three) from the outstanding purchase order file, inspect the material, circle the quantity received, and then sign and date block 26 of the DD Form 1155. The copies are distributed as follows:

- Copy signed by the inspector and one additional copy are placed under lock and key by the FSO until receipt of the dealer's bill.
- One copy is delivered to the records storekeeper for posting to the NAVSUP Forms 335 and 367 and placed in the appropriate receipt file.
- All remaining copies are returned to the outstanding purchase order file pending receipt of the dealer's bill.
- The storeroom storekeeper should remove the copy of the applicable DD Form 1155 from the

incoming material file, circle the quantity accepted, sign it (accepting responsibility), and deliver it to the FSO who will place it in his or her accountability file.

An exception to these procedures occurs when orders are placed for delivery over an extended period. In this case, after the storeroom storekeeper has signed each delivery ticket, assuming responsibility for the food items, the ticket is filed in the accountability file and the amount of the delivery noted on the DD Form 1155 at the end of the month. When final delivery has been made, the distribution of the DD Form 1155 will follow procedures as shown in items a through d.

FOOD STORAGE

All areas in which food items are stored must be kept clean and clear of unnecessary traffic and unpleasant odors. Care should be taken to keep food items away from areas where asphalt, fuel, creosote, or lubricating oils are present. Smoking in food storage spaces is prohibited to avoid fire and prevent certain food items from absorbing the odor or smoke. Items in damaged containers or bags will be issued immediate if they are fit for human consumption; otherwise, they will be surveyed. Inspect the food items regularly for signs of damage, spoilage, and insect or rodent infestation. More specific storage principles and procedures are discussed later in this chapter.

PRINCIPLES OF STORAGE

Certain basic storage principles and procedures must be observed regardless of the type of items. Organized storage spaces help facilitate storing, issuing, counting, cleaning, and safety. This organization will result in a quicker determination of items that are low and thereby avoid unplanned replenishment. Applying these principles will save you headaches and future problems.

Safety

Materials must be stored properly to prevent injury to the ship and the crew and to prevent damage to the material itself. Items that are stored overhead and on top of bins must be secured with particular care because the lashing or other means of securing maybe subjected to heavy strain while the ship is underway.

Accessibility

Supplies must be arranged in storage to facilitate breakouts. Items that are issued most frequently should

be located nearest to the breakout area. Whenever possible, avoid storing an item on top of or behind a totally different kind of material. Failure to observe this rule causes slow breakouts and slow and inaccurate inventories. Items must be stored so that, under ordinary conditions, the oldest stock will be the first issued; this process is the first in/first out (FI/FO) rule.

Orderliness

Case goods should be stored neatly in the storage area so that they can be counted by sight without being moved.

Safety, accessibility, and orderliness are closely interrelated and must be considered together. For instance, if for the sake of accessibility, you leave cases of canned goods stacked in the passageway, or if you do not secure them properly, you will violate rules of safety and orderliness. If such a practice were carried to an extreme, you would eventually have such confusion that accessibility would suffer also.

SEMIPERISHABLE FOOD ITEMS

The term *semiperishable* refers to food items that are canned, dried, dehydrated, or otherwise processed to the extent that such items may, under normal conditions, be stored in a nonrefrigerated space. While semiperishable food items are not nearly as prone to spoilage as perishable food items, spoilage can and will occur if the items are mishandled, improperly stored, or stored too long. Always remember the length of storage should be based on the packing date of the product and not the date of receipt.

Storage Principles of Semiperishable Food Items

When possible, store semiperishable food items in clean, cool, dry, well-ventilated storerooms. Check all items at regular intervals for signs of damage. Keep your storerooms clean to prevent the contamination of bagged foods by dirt and dust.

Separate and clearly mark shipments so that the oldest lots-as packed, not as received—are issued first. However, if newer lots show signs of deterioration or spoilage, they should be issued first.

Methods of storage depend on the size and the contents of the container and the bursting or breaking strength of the bottom layers. Care must be taken not to stack items too high because of the danger of bursting or crushing the bottom layers.

Do not stack items near steam or other heated pipes. Use pallets or deck grating to raise the items off the deck and stack individual lots so as to permit proper circulation of air and facilitate cleaning.

Bagged items and those requiring insect control should not be stored in large lots in corners of the storeroom or directly against the bulkhead. This type of storage will not permit sufficient room for cleaning and inspecting. When possible, palletized storage should be used to ease the handling of the stores and reduce losses through breakage in handling.

The safe storage period for dry food items varies greatly, depending on such elements as temperature, humidity, care in handling, protection from the weather, quality of the food when received, and the packing. Food items that have been on hand beyond the safe storage limit should be inspected for spoilage, leakage, or other damage. If such items are in good condition, use them as promptly as possible. Survey all items unfit for human consumption according to the NAVSUP P-486, volume I.

Rotation of Semiperishable Food Items

The publication, *Retail Subsistence Management*, NAVSUP P-581, contains detailed information regarding the rotation of semiperishable food items. Study the tables given in appendix E carefully. It is not practical to memorize them, but by careful study you should develop general ideas about the keeping times of the various foods and the changes that indicate a food item has been kept too long. The keeping times shown are average keeping times for products stored at 70°F. The 70°F temperature is representative of average temperatures at most Navy stock points. Keeping times will be reduced by approximately 50 percent if storage temperatures are maintained at 90°F. Keeping times will be increased by approximately 100 percent if storage temperatures are maintained at 40°F.

PERISHABLE FOODS

All foods are perishable. The term *perishable* as applied here refers to food items requiring refrigeration and special handling.

All fresh and frozen food items are highly perishable and subject to rapid deterioration when improperly stored. They require accurate temperatures, controlled humidity, air circulation, and special care in keeping the storage space sanitary. Failure to maintain any one of these conditions will result in rapid spoilage and eventual loss. Most spoilage in fresh and frozen

food items is caused by bacteria and fungi and spreads rapidly from the decayed items to the sound food items.

You may be assigned as the MS in charge of the cold storage area. When such is the case, your duties regarding storage and care of fresh and frozen food items are as follows:

- Make frequent inspections, sort, and remove any decayed items or portions. This will keep losses and surveys to a minimum.
- Separate and mark shipments to make clear their relative ages. This allows the issue of oldest food items first unless there is some reason (such as the condition) for giving a newer lot priority.
- Inspect food items to make sure Department of Defense (DOD) requirements are met. In the event frozen stores are received in a thawed or partially thawed condition, seek medical advice and refer to the NAVSUP P-486, volume I, for survey procedures.

Fresh Fruits and Vegetables

Raise the containers off the deck with pallets or gratings away from bulkheads and cooling coils and provide space between stacks, and at least 6 inches of clearance between tops of stacks and the opening of the air ducts to permit the circulation of air. In some cases it may be necessary to use a fan to maintain adequate circulation of all parts of the storeroom.

SAFETY PRECAUTION: When fresh fruits and vegetables are stored in a tight compartment at temperatures of 40°F or higher, the concentration of the carbon dioxide produced by respiration may reach a level in which it is unsafe to work. One way to check the amount of carbon dioxide present in a room is to light a match or candle. If the light is extinguished, do not work in the space until fresh air has been introduced.

Meat and Meat Products

Proper circulation of air is of prime importance in keeping the desired temperature in all parts of the meat storage space. Do not stack cases directly on the deck; use pallets or deck gratings to allow free circulation of air under all items stored in the space. Stacks should be at least 4 inches from the bulkhead or refrigeration coils. Generally, when the recommended temperature in all parts of the refrigerated space is uniform within the stacks, the circulation of air in the space is considered adequate.

Frozen Fruits and Vegetables

Frozen fruits and vegetables are highly perishable unless properly stored. Upon delivery, they must be transferred promptly to a low-temperature storage space. Check the temperature of the load upon arrival by taking temperature readings of cartons selected from top layers inside of shipping cases.

When the temperature is found to be higher than that of the freezer room, scatter the shipping cases loosely about the room on hand trucks or on the deck with adequate space between individual cases to permit rapid lowering of the product temperature to the freezer room temperature. Use of a portable fan to create an air current over the items will speed up temperature equalization. When the temperature of the items has been lowered sufficiently, stack the cases compactly at once. Stack from the bulkhead toward the center of the room, starting about 4 inches from the bulkhead or bulkhead coils. Stack the cases on pallets to permit the circulation of air under them. The use of pallets will also improve the sanitary conditions. In rooms where cold air is expelled directly from blower units at the ends of the rooms, the cases should be stacked low enough to permit air circulation. Allow at least 2 feet between the top of the stack and the overhead or air ducts.

Dairy Products and Eggs

Keep the cold storage room for dairy products and eggs fresh by keeping it clean and by circulating the air slowly. Air circulation can be increased by the use of pallets or deck gratings and by the proper stacking of the various lots.

REFRIGERATION UNITS

Three factors affect the rate at which frost and ice accumulate on refrigerator coils: (1) door traffic, (2) excessive temperature difference between the coils and the box, and (3) moisture from the stored materials. In each case the buildup can be reduced by properly planned and executed breakout procedures. Measures discussed in the following paragraphs may be used to prevent excessive icing of coils.

Door Traffic

Breakouts should be planned for a full day's requirements. All messes must draw their frozen subsistence items at a predetermined time, usually in the morning. Any items withdrawn at this single daily breakout from the freeze box, if not intended for

immediate use, should be stored temporarily in the chill box.

This one breakout per day should be strictly enforced. With a little planning on the part of the various messes, it should not be too difficult. In this way, the reefer temperature will remain constant and excessive icing from too much door traffic will be kept to a minimum.

Temperature Controls

A difference in the temperature of the refrigerated spaces and the refrigeration coils will cause vapor to form on the coils and the refrigeration coils will turn the vapor into ice. This ice formation continues until the temperatures of the coils and the refrigerated spaces equalize.

The temperatures of the coils and the refrigerated spaces are likely to differ most during the period when the freeze box is being restocked. The higher temperature of the food items being stored will cause a rise in temperature in the refrigerated space and produce vapors. There is no way to prevent this condition, since the work of storing must go on. However, once the storage has been completed, the box should remain closed until the normal temperature level of the freeze box has been reached.

Air Circulation

Proper storage and adequate air circulation help prevent excessive ice formation. Continuous circulation by electric blowers is necessary at all times. Storage arrangements should allow free circulation of air throughout the box.

Adequate aisles and overhead space should be provided to permit the free circulation of air from the blowers. Blowers should be inspected each day to ensure proper operation. Any malfunction in the circulating unit should be reported to the duty engineer immediately.

Defrosting and Cleaning Refrigerators

The refrigeration coils and units in cold storage spaces should be defrosted as often as possible. A layer of frost or ice 1/4 or more inches thick will reduce the efficiency of the refrigeration system and may result in overloading the compressors. Always consult the engineering department regarding the defrosting of the refrigeration system.

Most refrigeration units are so equipped that hot gas can be run through the cooling coil to melt the ice. Then the bulkheads, the overhead, and the deck remain cold because of the speed with which the coils are defrosted, and there is no necessity for moving the food. This method of defrosting should be used on all ships equipped with such a hot gas capability, since refrigeration is not interrupted.

If your cold storage plant is not of this type, it will be necessary to consult with the engineering department to determine other methods of defrosting. And, of course, you should never use an ice pick or a sharp tool to pick ice from the coils.

Once defrosting is completed by a nonhot gas method, scrub and wash the box thoroughly with hot soapy water. Rinse, dry, and air the box and return the food to its place immediately.

Refrigerator Log

A refrigerator (or reefer) log must be maintained by the person responsible for the refrigerated spaces. Temperature readings must be taken twice daily and at other times as necessary. The reefer log is presented daily to the leading MS and the FSO for review and initialing. Temperature irregularities must be reported to the leading MS and the FSO immediately.

EXPENDITURES

Food items may be expended by issue, transfer, sale, or survey.

ISSUES

Issues (or breakouts) of food items to the GM must be made on preapproved breakout documents and follow established procedures. These procedures are explained next.

Bulk Storeroom to Issue Storeroom Procedures Afloat

Breakouts of food items from the bulk storeroom to the issue room must not be made without an approved issue document, such as a Food-Item Report/Master Food Code List, NAVSUP Form 1059, or a Food-Item Request/Issue Document, NAVSUP Form 1282.

ISSUING PROCEDURE.— Requests for breakouts from the bulk storeroom must be made on a NAVSUP Form 1282 or a NAVSUP Form 1059, each prepared in triplicate. (See figs. 2-11 and 2-12.)

DOCUMENT DISTRIBUTION AND POSTING.— The completed form is signed by both the bulk storeroom and issue storeroom storekeepers and distributed as follows:

- The original is retained under lock and key by the FSO.
- The duplicate is retained by the bulk storeroom storekeeper for posting to the NAVSUP Form 209 or the NAVSUP Form 335, whichever is used.
- The triplicate is retained by the issue room storekeeper for posting to the NAVSUP Form 209 or the NAVSUP Form 335.

Issue Storeroom to Galley Procedure

Breakouts to the galley from the issue storeroom are made on an approved NAVSUP Form 1282 or NAVSUP Form 1059.

DOCUMENT PREPARATION.— The FSO establishes controls to account for each breakout document. When dry, fresh, and frozen items are in the custody of different individuals, separate breakout documents must be prepared (fig. 2-11).

When the NAVSUP Form 1282 is used, care must be taken to list items in the order in which they appear on the NAVSUP Form 1059. The food item code number from the NAVSUP Form 1059 must be entered to assist with posting to the NAVSUP Form 335 and to the NAVSUP Form 209. (See figs. 2-11 and 2-12.)

REQUIRED SIGNATURES.— Signatures on breakout documents serve as authorization and transfer accountability. Therefore, the importance of following established procedures cannot be overemphasized.

ISSUES.— The jack-of-the-dust (issue room storekeeper) issues the food items requested using a NAVSUP Form 1282, enters the actual quantities furnished, and delivers the items to the senior MS on duty. The jack-of-the-dust and the individual accepting the material sign in the Issued By and Received By blocks respectively.

RETURN OF FOOD ITEMS.— Strict accountability must be exercised over food items at all times to minimize waste and to make sure items are used for the purpose intended. Unused food items that are being returned must not be kept in the galley. These items (often referred to as breakbacks or returns) must be promptly returned to the storeroom so that accountability can be reestablished. Returns may be

NAVSUP FORM 1282 (REV. 5-82)

FOOD ITEM REQUEST/ISSUE DOCUMENT (1440)

REQUISITIONED BY (Signature, Rate and Title)

APPROVED BY (Signature, Rate and Title)

ASSIGNED BY FOOD SERVICE OFFICER

SIGNATURE OF SENIOR MS ON DUTY

FOOD CODE	DESCRIPTION OF MATERIAL	UNIT	QUANTITY		UNIT PRICE	VALUE
			REQUESTED	ISSUED		
A03	Bacon, sliced, Pre #10	CN	1	1	32.99	32.99

SIGNED BY (Signature, Rate and Title)

DATE

SHEET TOTAL 32.99

RECEIVED BY (Signature)

DATE

SUB TOTAL

DATE

BAKERY FOOD ()

DATE

GRAND TOTAL 32.99

I CERTIFY THAT _____ is an enlisted dining facility

SIGNATURE _____ DATE _____

POSTED TO 209 338 338 OTHER

SIGNATURE OF FOOD SERVICE OFFICER

ENTER FOOD ITEM CODE FROM NAVSUP FORM 1059

NAVSUP FORM 1059 (REV. 11-81)

FOOD ITEM REPORT/MASTER FOOD CODE LIST (10110)

DOCUMENT NO. _____

ASSIGNED BY FOOD SERVICE OFFICER

CODE	NSN	NOMENCLATURE	U/I	QUANTITY		UNIT PRICE	VALUE
				REQ'D	ISSUED		
A21		MEAT, POULTRY, AND FISH					
A22							
A23	M-036-0395	Bacon, Sliced, Precooked, #10	CN	1	1	32.99	32.99
A24							
A25							
A26	M-316-8104	Beef Chunks, 1# or	CN				
A27							
A28	M-751-2206	Chicken, Inned, 1# or	CN				
A29		Clams, minced, 1# or					
A30							

SUBTOTAL 1

TOTAL OF ALL SUBTOTALS 1

LESS GALLEY PRODUCED BAKERY PRODUCTS SOLD 1

GRAND TOTAL 1

Issue Approved by (Signature, Rate & Title)

ISSUED BY (Signature, Rate & Title)

SIGNATURE OF SENIOR MS ON DUTY

RECEIVED BY (Signature, Rate & Title)

SIGNATURE OF SUBSISTENCE ISSUE ROOM STOREKEEPER

I CERTIFY THE FOREGOING TO BE A TRUE STATEMENT.

SIGNATURE OF MS RECEIVING FOOD ITEMS

SIGNATURE _____

SIGNATURE OF FOOD SERVICE OFFICER

Figure 2-11.—Preparation of the Food-Item Request/Issue Document, NAVSUP Form 1282, and the Food-Item Report/Master Food Code List, NAVSUP Form 1059.

made on the original issue document, NAVSUP Form 1282. This form is signed in the Issued By block by the senior MS on duty and in the Received By block by the jack-of-the-dust.

DOCUMENT DISTRIBUTION AND POSTING.— The jack-of-the-dust retains one copy of the issue document for posting to the NAVSUP Form 209 or the NAVSUP Form 335 and then delivers the

original and the remaining copy to the GM keeper.

Issues From Combined Bulk and Issue Storerooms

On some ships, the bulk storeroom storekeeper is accountable for both the bulk and issue storerooms. Under this type of combined operation, the issue room

FOOD ITEM REQUEST-ISSUE DOCUMENT NAVSUP 1282 (REV. 10-78) SUP-0108 LF 301 2820						DOCUMENT NO.	
REQUISITIONED BY (Signature, Rate and Title)				REQ. DELY DATE	APPROVED BY (Signature, Rate and Title)		
FOOD CODE	DESCRIPTION OF MATERIAL	U/I	QUANTITY			UNIT PRICE	VALUE
			REQUESTED	ISSUED	RETURNED		
ISSUED BY (Signature, Rate and Title)		DATE	SHEET TOTAL				
RECEIVED BY (Signature, Rate and Title)		DATE	SUB TOTAL				
			BAKERY PROD. ()				
			GRAND TOTAL				
I CERTIFY THAT _____ DOCUMENTED ISSUES & THIS STATEMENT OF ISSUES TO _____ DATE _____							
SIGNATURE _____ DATE _____							
POSTED TO	209	335	338	OTHER			
PAGE ____ OF ____							

PREPARATION OF THE FOOD ITEM REQUEST ISSUE DOCUMENT (NAVSUP FORM 1282)
Procedures for preparation and completion of the NAVSUP Form 1282 with explanatory notes are as follows:

Caption	Expansion
Document No	Assigned from Document No. Control Log i.e., G-001 (Galley), VP-001 (Vag Prep), BA, 0001 (Bake Shop), BU-0001 (Butcher Shop)
Requisitioned by	Watch captain, vegetable preparation supervisor, Bake shop supervisor, butcher shop supervisor
Date of consumption	Actual date material will be used
Approved by	Senior MS on duty
Food item Code	Taken from NAVFSSONOTE 7330 series (Fixed Price List)
Description of material	Self-explanatory
U1	Self-explanatory
Quantity requested	Completed by watch captain work center supervisor
Quantity issued	Completed by issue room storekeeper
Quantity returned	Completed by issue room storekeeper
Net issue	Completed by issue room storekeeper
Unit price	Completed by records keeper
Value	Completed by records keeper
Issued by	Signed by issue room storekeeper at time of issue
First received by	Area supervisor at time of receipt
Returned by	Watch captain area supervisor at time of turnin
Second received by	Issue room storekeeper at time of receipt of turnin
Certification	Food service officer will review completed issue document and certify that the food item issued support the menu of the day
Signature/date	Food service officer after review
Posted to	Self-explanatory

PREPARATION OF THE FOOD ITEM REQUEST ISSUE DOCUMENT (NAVSUP FORM 1282)
Procedures for preparation and completion of the NAVSUP Form 1282 with explanatory notes are as follows:

Caption	Expansion
Document No	Assigned from Document No. Control Log i.e., G-001 (Galley), VP-001 (Vag Prep), BA, 0001 (Bake Shop), BU-0001 (Butcher Shop)
Requisitioned by	Watch captain, vegetable preparation supervisor, Bake shop supervisor, butcher shop supervisor
Date of consumption	Actual date material will be used
Approved by	Senior MS on duty
Food item Code	Taken from NAVFSSONOTE 7330 series (Fixed Price List)
Description of material	Self-explanatory
U1	Self-explanatory
Quantity requested	Completed by watch captain work center supervisor
Quantity issued	Completed by issue room storekeeper
Quantity returned	Completed by issue room storekeeper
Net issue	Completed by issue room storekeeper
Unit price	Completed by records keeper
Value	Completed by records keeper
Issued by	Signed by issue room storekeeper at time of issue
First received by	Area supervisor at time of receipt
Returned by	Watch captain area supervisor at time of turnin
Second received by	Issue room storekeeper at time of receipt of turnin
Certification	Food service officer will review completed issue document and certify that the food item issued support the menu of the day
Signature/date	Food service officer after review
Posted to	Self-explanatory

Figure 2-12.—Preparation explanation notes and the Food-Item Request/Issue Document, NAVSUP Form 1282.

becomes an extension of the bulk storeroom for accountability purposes. Thus, the same issue documents may be used for breakouts from the bulk storeroom to the galley and for reporting issues to the GM drawn from the issue room. When you are using this procedure, only items for immediate use are to be requested from the bulk storeroom or drawn from the issue room. Care must be taken to make sure no excesses are drawn and stored in the galley causing the issues to the GM to be overstated. Any food items remaining in the issue room under the combined accountability procedure must be counted and reported with the bulk storeroom items when inventory is taken.

RETURNS OR TURN-INS.— Unprepared food items remaining in the galley after completion of meal periods in which the items were intended to be used must be returned to the storeroom on a daily basis. The NAVSUP Form 1282 containing daily issues must be modified to document items and quantities returned and thereby show the new issues to the GM. Procedures for

turn-ins are the same as explained earlier under the Issue Storeroom to Galley Procedures heading.

DOCUMENT DISTRIBUTION AND POSTING.— The bulk storeroom storekeeper retains one copy of the issue document for posting to the NAVSUP Form 209 or the NAVSUP Form 335 and then delivers the original and the remaining copy to the GM records keeper.

TRANSFERS

Occasionally, the need to transfer food items between GMs is necessary. You may be told by the leading MS or FSO to estimate the quantities of the requested food items that may be spared for transfer to another GM. In reviewing your stocks of the requested items, you should make a complete check against the planned menu and consider the length of time before replenishment of the requested food items. Then, you should make your recommendation. This

recommendation should not jeopardize the operating capability of your GM.

Transfer Documents

Transfers of food items between ships and GMs ashore must be covered by a DD Form 1149 or a DD Form 1348m or some other document required by the transferring activity. These documents must be prepared with an original and five copies.

Distribution and Posting

The copies of the transfer document are distributed to the receiving activity and three copies are kept at the transferring activity. The subsistence bulk storeroom storekeeper posts issues to the NAVSUP Forms 209 or the NAVSUP Forms 335 in the Other column and then gives the copies to the GM records keeper.

SALE OF FOOD ITEMS

Food items may be sold to private messes afloat and Navy/Marine Corps officer and enlisted clubs ashore if approved by the commanding officer.

Sales to Afloat Private Messes

When food items are sold directly from the GM to a private mess, the authorized representative of the private mess will prepare a NAVSUP Form 1282. The NAVSUP Form 1282 will be signed by the private mess manager or treasurer, or an authorized representative. If a person other than the private mess manager or treasurer is authorized to sign requisitions, such authority will be furnished to the FSO in writing. The signed requisition will be forwarded for approval by the FSO or the designated representative. The approved requisition will be priced and extended at the last receipt unit price in effect at the time of issue with the exception of donated dairy products that will be sold at fixed prices. The GM representative and the jack-of-the-dust will sign for receipt and issue of the material and the NAVSUP Form 1282 will be distributed as follows:

- Signed original to the FSO to be held under lock pending preparation of the billing document.
- Signed duplicate to the mess treasurer.
- Signed triplicate, forward to the GM records keeper used for posting to the NAVSUP Form 335. After posting is completed, this copy is placed in the cash sales file.

Sales to authorized private messes will be posted to the NAVSUP Form 335 as they occur. The value of sales to the private messes will be posted to the NAVSUP Form 367 monthly from a copy of the billing document. Under no circumstances will unprepared food items furnished from the GM to a private mess be billed on the basis of meals consumed.

Sale of Galley Bakery Products

NAVFSSO will issue a price list that will be used in pricing the galley-produced bakery products sold to private messes. This price list is revised on a 6-month cycle or as required by changes in prices of the basic ingredients. The cost of galley-produced bakery products that do not appear in the price list is established at the local level based on the last receipt invoice prices for the basic ingredients. At the option of the FSO, a quarterly price list based on the last receipt prices of basic ingredients and approved by the commanding officer or the commanding officer's designated representative may be established for all galley-produced bakery products. In no case will locally established prices be less than the current prices issued by NAVFSSO.

A separate issue document, NAVSUP Form 1282 (fig. 2-13), is used for galley-produced bakery products. This form is submitted in triplicate, listing the items and quantities required, and is signed by the mess treasurer or the mess treasurer's designated representative. The approved document is presented to the baker for issue of the products. When issues are made, the authorized representative of the private mess will sign the original and two copies of the NAVSUP Form 1282 for receipt of the items and the issue document will be distributed as follows:

- Original, priced and extended, to the FSO to be kept under lock and key until used for preparation of the monthly billing document. (Galley-baked products should be listed separately on the monthly billing document to facilitate deduction from the quarterly recap of issues to the GM part of the retained returns.)
- Duplicate to the mess treasurer of the private mess.
- Triplicate to the GM records keeper to be subtracted from the daily value of issues to the NAVSUP Form 1282 for the GM.

The value of galley-produced bakery products sold will be deducted from the total value of issues to the GM before posting to the General Mess Control Record,

SIGNATURE OF MESS TREASURER OR DESIGNATED REP

SIGNATURE OF FOOD SERVICE OFFICER OR DESIGNATED REP

FOOD ITEM REQUEST/ISSUE DOCUMENT (4400)
NAVSUP FORM 1282 (REV. 5-82)

REQUISITIONED BY (Signature, Rate and Title)

DATE FOR CONSUMPTION

DOCUMENT NO. WR 024
APPROVED BY (Signature, Rate and Title)

FOOD CODE	DESCRIPTION OF MATERIAL	U/I	QUANTITY				UNIT PRICE	VALUE
			REQUESTED	ISSUED	RETURNED	NET		
W80	Doughnuts, iced	DZ	3	3			.26	.78
W98	Rolls, sweet, iced	DZ	4	4			.19	.76

FROM PRICE LIST FOR GALLEY-PRODUCED BAKERY PRODUCTS (NAVFSSNOTE 7330 SERIES)

NOTE: THIS INFORMATION IS TYPED ON ILLUSTRATION ONLY FOR LEGIBLE PRINTING PURPOSES

ISSUED BY (Signature, Rate and Title) → SIGNATURE OF BAKER DATE

RECEIVED BY (Signature) ← SIGNATURE OF WARDROOM REPRESENTATIVE

FORWARDED BY (Signature) BY (Signature)

SHEET TOTAL 1.54

SUB TOTAL

DEDUCTED FROM THE DAILY AND QUARTERLY ISSUES TO THE GENERAL MESS INCLUDED ON THE MONTHLY BILLING DOCUMENT

NUMBER OF DOCUMENTS → 1

I CERTIFY THAT _____ document(s) is/are a true statement of issues to WARDROOM MESS

SIGNATURE → SIGNATURE OF FOOD SERVICE OFFICER DATE _____

POSTED TO 209 335 338 OTHER

Figure 2-13. Sale of galley-baked products on a NAVSUP Form 1282.

NAVSUP Form 338. At the end of the accounting period the total value of galley-baked products sold to each private mess will be subtracted from the stores consumed.

Posting

The quantity of each item must be posted to the Other column of either the NAVSUP Form 209 or the NAVSUP Form 335 by the subsistence bulk storeroom storekeeper or the jack-of-the-dust. Then this information is forwarded to the GM records keeper for completion of the posting and accounting processes.

SURVEYS

The Navy term survey means the disposition of material after a loss situation has been investigated.

Purpose

The purpose is to expend materials from the records that are damaged, obsolete, deteriorated, lost, or stolen. The purpose also includes a review of the existing condition of the materials, the cause and responsibility

for this condition, and the recommendation for the final disposition of the materials.

Document

The document used depends on the reason for the survey. Refer to the NAVSUP P-486, volume I, for guidance on document usage and preparation.

Loss Without Survey

Food items accounted for in appropriations, Military Personnel, Navy, may be expended with the Loss without Survey, NAVSUP Form 1334, when culpable responsibility is not involved and in either of the following instances:

- Material is short or lost in shipment, and the value of the loss is less than \$50 per line item.
- Food items lost as a result of physical deterioration; veterinary sampling; damage in handling, fire, water, or similar circumstances; and the value of the loss is \$500 or less per line item.

A NAVSUP Form 1334 (fig. 2-14) is used to expend food items under these conditions. Repetitive

EXPENDITURE LOG (4442) (Loss without Survey) NAVSUP FORM 1334 (7-73)		ACTIVITY NAME, MAILING ADDRESS, AND UIC CODE MUST BE INSERTED		PERIOD					
DATE		STOCK NUMBER	ITEM NAME	U/I	QTY	LAST RECP'T PRICE	TOTAL VALUE	REASON FOR LOSS	FOOD SERVICE OFFICER (Signature)
1/11	8915-00-126-8748	V11 Bananas	LB	62	.15	9.30	Spoiled-in poor condition when received	SIGNATURE OF FOOD SERVICE OFFICER FOR EACH LINE ITEM	
2/19	8910-00-926-6048	U69 Eggs	DZ	55	.62	34.10	Spoiled-reefer failure		
2/19	8905-00-582-4051	Q64 Chicken	LB	75	.46	34.50	Spoiled-reefer failure		
3/16	8915-00-616-0191	V70 Lettuce	LB	55	.16	8.80	Received in poor condition		
3/21	8925-00-782-2983	Y08 Syrup	HD	2	3.00	6.00	Lost in shipment		
3/21	8940-00-616-0226	K33 Pie Filling, Apple	CN	3	2.80	8.40	Damaged in shipment		
TOTAL NET VALUE							101.10		

NOTE: INFORMATION IS TYPED ON ILLUSTRATION ONLY FOR LEGIBLE PRINTING PURPOSES

POSTED TO NAVSUP FORM 367 AND INCLUDED IN "SURVEYS AND LOSS WITHOUT SURVEY" CAPTION IN THE EXPENDITURES SECTION OF NAVSUP FORM 1358

Figure 2-14.—Loss without survey on an Expenditure Log, NAVSUP Form 1334.

entries of the same item for the purpose of circumventing maximum dollar limitations will not be allowed.

When the total loss of several items expended for the same reason—replenishment evolution, periodic shelf-life review, flood, fire, and so forth—exceeds \$1,000, a DD Form 200 will be completed as required.

MAINTENANCE OF RECEIPT AND EXPENDITURE RECORDS

Although the supply officer or FSO is responsible for requisitioning and procuring food items, in some instances, you may be required to perform these duties. In either case, you will need to maintain receipt and expenditure records. The following paragraphs explain the use of the Requisition Log, NAVSUP Form 1336, and the Record of Receipts and Expenditures, NAVSUP Form 367.

Requisition Log

Maintaining the Requisition Log, NAVSUP Form 1336, is optional for all ashore and afloat activities. The requisition log provides requisition documentation control and information on outstanding requisition documents and receipts. It also provides a breakdown of receipts with and without charge. Outstanding requisitions that are brought forward to the current month's requisition log should carry the same requisition document numbers assigned on the previous month's log.

Instead of maintaining the Requisition Log, NAVSUP Form 1336, all receipts without charge will be annotated with W/O in the left-hand margin on the NAVSUP Form 367. At the end of each month, the receipts with charge file will be used as the source file for determining the dollar value of the Receipts With Charge block for the monthly NAVSUP Form 1357. This value can also be verified using the NAVSUP Form 367 by totaling all receipts not annotated W/O.

Receipt document filing requirements are as follows:

- The original will be signed by the bulk storeroom custodian and filed in the accountability file.
- A copy will be signed by the receipt inspector and filed in the receipts with charge file or receipts without charge file.

- No other copies need be retained. Only the records keeper is required to maintain completed requisition or purchase order files for accountability.

Record of Receipts and Expenditures

The NAVSUP Form 367 will be used to record receipt transactions and also expenditure transactions by total money value for the accounting period. This record will be maintained in the records office and transactions will be posted as explained next.

RECEIPT TRANSACTIONS.— Receipt transactions recorded will include value of inventory carried forward, receipts from transfers, and receipts from purchases. All receipt transactions are posted as they occur.

EXPENDITURE TRANSACTIONS.— Expenditure transactions recorded will include the following:

Transfers. The money value (extended at last receipt price) of each transfer will be posted to the NAVSUP Form 367 as occurring.

Special meals. The value of food items used in preparing special meals will be posted from the Special Meals Report, NAVSUP Form 1340.

Surveys. The money value of each Report of Survey, DD Form 200, will be posted as it occurs. Losses without survey will be posted when summarized from the Expenditure Log (Loss Without Survey), NAVSUP Form 1334, and posted to the NAVSUP Form 367 at the end of the accounting period and/or upon the relief of the FSO.

Sales to private messes. The money value of sales to private messes will be posted monthly to NAVSUP Form 367 from the billing document.

Issues to the GM. The money value (extended at fixed price) of issues to the GM will be posted at the end of each accounting period from the Food Item Report/Master Food Code List, NAVSUP Form 1059. This is a summary of issues to the GM for the accounting period it summarizes.

Inventory. The money value (extended at last receipt price) of the inventory, at the end of the accounting period, will be posted from the NAVSUP Form 1059.

Price adjustment. The value of the Receipts and Expenditures side of the NAVSUP Form 367 will be totaled. The difference between the totals will be posted

as an expenditure captioned Price Adjustment, thus bringing the receipts and expenditures into balance.

A copy of the NAVSUP Form 367 (fig. 2-10) will be included as part of the subsistence returns to NAVFSSO at the end of the accounting period.

INVENTORY

Inventory is conducted in the GM on a quarterly basis. Special inventories are conducted as required. The types of inventories and the inventory requirements are explained next.

Requirements

GM food items must be inventoried by the FSO on the last day of each quarter and before being relieved. Special inventory requirements are as follows:

- At the end of each patrol period of fleet ballistic submarines and upon relief of either the blue or the gold crew.
- Aboard ships without Supply Corps officers, an inventory must be taken before the relief of the commanding officer if an accountable FSO has not been named.

Types

As an MS, you will often be directed to conduct a variety of inventories, some of which may be quite unfamiliar to you. Listed next are short explanations of some of the common inventories held.

Quarterly inventory. This inventory is required in all GMs at the end of each quarter.

Optional inventory. In the interest of reducing the workload for the quarterly inventory, this type of inventory may be taken at any time during the last month of the quarter.

Spot inventory. This type involves frequent (twice weekly) counting of a small number of fast-moving, high-cost items.

Relief of accountable officer. When the FSO is relieved, a complete inventory is taken to establish the new FSO's accountability.

Preparation for Inventory

In preparation for the inventory, all receipts and expenditure documents should be posted to the NAVSUP Form 209, NAVSUP Form 335, and NAVSUP

Form 367. All GM food items should be arranged by case lots with labels facing out and in NAVSUP Form 1059 sequence, if possible.

Physical Inventory

When the FSO is being relieved, both the present and the relieving FSOs should take the inventory. Personnel assigned responsibility for GM stock should be present and participate in the inventory of their respective spaces. Separate rough inventories should be taken of areas assigned to different individuals. Food items should not be moved from one storage area to another during the inventory. The FSO should make sure no issue, transfer, or sale of food items is made from GM stocks except in an emergency. When such expenditures occur, the inventory should be adjusted and initialed by the persons taking the inventory.

RECORDING INVENTORY DISCREPANCIES.— The rough inventory should be recorded on the NAVSUP Form 1059 or other appropriate recording document. Regardless of the form used, the rough inventory must be recorded in ink. Only an original rough inventory will be prepared. Errors and adjustments should be lined out, but not obliterated. Corrections must be initialed by the persons responsible for the inventory. Each page of the rough inventory must be signed by the FSO and the persons responsible for the storage areas.

RECONCILING INVENTORY DISCREPANCIES.— The quantities on the rough inventory will be compared with the balances on the NAVSUP Form 335. A list should be made of discrepancies between inventory quantities and on-hand balances. These discrepancies will be rechecked by the persons conducting the inventory. All discrepancies greater than 5 percent of total expenditures will be investigated and initialed by the FSO. If the inventory is initially correct, it may be posted at that time. However, if there are discrepancies, these discrepancies should be resolved before posting. If a discrepancy cannot be resolved, an inventory adjustment should be made. Required corrections will be made to the rough inventory and initialed by each person involved with the inventory.

AFTER THE INVENTORY.— After all the corrections have been made, the inventory should be recapped in duplicate on a NAVSUP Form 1059. The FSO should compare the smooth recapped inventory with the rough inventory before signing the smooth inventory. The rough inventory sheets should be placed in the accountability file until the next inventory has

been completed, after which they may be destroyed. The original and duplicate of the smooth inventory should be priced at the last receipt prices, extended, and totaled. The original should be retained by the FSO and filed with the retained returns.

The duplicate copy should be used for posting to the NAVSUP Forms 209, 335, and 367. Inventory quantities should be posted to the NAVSUP Form 209 and the NAVSUP Form 335. The total value of the inventory should be posted to the Expenditures side of the NAVSUP Form 367. After posting is completed, the duplicate copy should be used to prepare returns and then destroyed except for a copy to be retained by the relieving accountable officer.

Optional Inventory Posting Procedure

Upon completion of the inventory, quantities on hand are posted to the NAVSUP Form 335. Quantity

differences (either plus or minus) between the inventory and the NAVSUP Form 335 balances are posted to the Issued to General Mess column of the NAVSUP Form 335 and to the NAVSUP Form 1059 or the NAVSUP Form 1282, on which each item is priced using fixed prices, extended, and totaled. The total value of the differences is posted to the General Mess Control Record, NAVSUP Form 338, to reflect the actual food cost.

At the end of the quarter, the quantities on hand, as shown on the NAVSUP Forms 335, are posted to the NAVSUP Form 1059. These forms should be priced at last receipt prices, extended, totaled, and signed by the FSO. The value is posted to the NAVSUP Form 367 as the value of subsistence inventory carried forward at the end of the accounting period and is reported under Expenditures in the Balance Sheet section of the General Mess Operating Statement, NAVSUP Form 1358, opposite the caption Balance on Hand.

CHAPTER 3

ACCOUNTING

The objective of any system of records maintained by a messing facility is to provide a source of data to be used in the preparation of the required financial statements for that messing facility. When properly maintained, these records will also provide information that allows a more efficient operation of a messing facility. Improperly kept records tend to support practices that will lead to inefficiency and cause losses of money and material.

The types of financial records and reports that are required to be maintained by the general and private mess are discussed in this chapter.

GENERAL MESS ACCOUNTING SYSTEMS

All general messes (GMs) use an end-use accounting procedure, whereby activities may account for receipts and expenditures of items under the appropriation Operation and Maintenance, Navy (O& M,N). Returns are also prepared for periods when a GM is closed. Food items are received and stocked primarily to be consumed by the reporting activity. Under this authority, a GM uses the General Mess Operating Statement, NAVSUP Form 1358.

PREPARATION OF THE GENERAL MESS OPERATING STATEMENT

The NAVSUP Form 1358 is the principal foodservice report and is submitted at the end of each quarterly accounting period. This form is prepared in an original and two copies. The original and one copy are forwarded to the Navy Food Service Systems Office (NAVFSSO) by the 10th day following the end of the accounting period and one copy is retained by the food service officer (FSO). Aboard fleet ballistic submarines, the NAVSUP Form 1358 is prepared and submitted for the time period (patrol) that the mess is administered by each crew (blue and gold). The Record of Receipts and Expenditures, NAVSUP Form 367, and the General Mess Rations and Sales Report, NAVSUP Form 1357, are used in preparing the NAVSUP Form 1358. See figure 3-1. All monetary values are rounded to the nearest dollar, except the rates for computing allowances. For more information on the preparation of

the NAVSUP Form 1358, refer to the NAVSUP Publication 486, volume I, chapter 9.

SUBMISSION OF RETURNS

A NAVSUP Form 1358, original and one copy, with the substantiating documents prescribed are submitted by the FSO as follows:

- Within 10 days following the end of each regular accounting period
- Within 15 days following the end of an accounting period with overissue
- When the return of one period is merged with a previous or following period, but no later than 10 days following the latter merged period

Fleet ballistic submarines render a NAVSUP Form 1358, regardless of fiscal quarter or fiscal year, for each period the GM is administered by a particular crew (blue or gold). An alphabetic suffix B or G is added to the unit identification code to indicate a blue or gold crew. For example, SSBN 598 will render subsistence returns under unit identification code 5106(B) or 5106(G), as applicable.

Relief of the Accountable Food Service Officer

Upon relief of the FSO, an inventory is taken by both the relieved and relieving officers, and the stock records are balanced but not closed out. A copy of the relieving inventory is forwarded to NAVFSSO immediately after completion. NAVFSSO audits the relieving inventory and verifies FSO accountability. The accounts receivable of the relieved officer are transferred to the relieving officer. The relieving officer receipts for the monetary value of the inventory and submits returns at the end of the regular quarterly accounting period. If the relieving officer is not satisfied that accountability is within the prescribed limits according to the NAVSUP P-486, the commanding officer may direct the officer being relieved to close the records and submit a return for his or her period of accountability, which is usually a fractional period of the regular quarterly accounting period. The relieving officer then renders a return for

GENERAL MESS OPERATING STATEMENT (7330)		ACTIVITY NAME, MAILING ADDRESS, AND UIC CODE MUST BE INSERTED		NAVSUP REPORT 7330-B		
ACTIVITY (Name and mailing address)		PERIOD 1 JAN 199_ THRU 31 MAR 199_		DAYS IN PORT 6.7	FACILITY OPERATED (No. of days) 90	
NOTE: ROUND ALL VALUES TO NEAREST DOLLAR						
BALANCE SHEET		BEGINNING INVENTORY AT LAST RECEIPT PRICES		IF AT SEA DURING ENTIRE ACCOUNTING PERIOD INSERT A ZERO (0) IN THIS BLOCK		
RECEIPTS		TYPE OF PERSONNEL		RATIONS FED		
BALANCE BROUGHT FORWARD 1/	\$ 11,258	NAVY (Enlisted)		18,938	2/ 12,499	
RECEIPTS WITH CHARGE 2/	38,572	TOTAL OTHER PERSONNEL		605	2/ 605	
RECEIPTS WITHOUT CHARGE	1,066	TOTAL RATIONS		19,543	2/ 13,104	
TOTAL		COMPUTATION OF ALLOWANCES/FINANCIAL STATEMENT				
EXPENDITURES		VALUE	TYPE	RATIONS	RATE	VALUE
STORES CONSUMED	FIXED PRICES	35,441	BASIC ALLOWANCE	2/ 13,104	\$ 2.67	\$ 34,988
SPECIAL MEALS		190	100-149	13,104	.10	1,310
SURVEY & LOSS WITHOUT SURVEY		730	SPECIAL/SUPPLEMENTAL ALLOWANCES			
SALE OF BULK FOOD ITEMS 2/	LAST RECEIPT PRICES	1,051	ENSURE THAT THE RATES USES ARE CURRENT WITH THE RATES ISSUED BY NAVFSSNOTE 7330 SERIES (FIXED PRICE LIST) FOR REPORTING PERIOD			
TRANSFERS WITH REIMBURSEMENT		661	SUBMARINES			
TRANSFERS WITHOUT REIMBURSEMENT		217	SIGNATURE AND DATE INSERTED BY COMMANDING OFFICER, OR FOOD SERVICE OFFICER IF SO DESIGNATED AS ACCOUNTABLE (SHIPS W/O SUPPLY CORPS OFFICERS)			
BALANCE ON HAND	ENDING INVENTORY AT LAST RECEIPT PRICES	13,728	TOTAL ALLOWANCES			\$ 36,298
PRICE ADJUSTMENT		-1,122	STORES CONSUMED			35,441
TOTAL		\$ 50,896	REVIEWED BY LEADING			OVER/UNDER ISSUE \$ 85.7
NOTES		The figures contained in this column are correct to the best of my knowledge and belief.		I CERTIFY that the above information is correct to the best of my knowledge and belief.		
1 / Balance on hand previous report		EXECUTIVE PERSONNEL		CERTIFIED BY (SIGNATURE) (RANK AND TITLE)		
2 / Equals the sum of the 3 monthly "Ration and Sales Reports"		SIGNATURE AND DATE INSERTED BY EXECUTIVE/PERSONNEL OFFICER		INITIALS OR SIGNATURE OF LEADING MS		
3 / Post "TOTAL RATIONS" figure from the "RATIONS FED" column.		SIGNATURE AND DATE INSERTED BY FOOD SERVICE OFFICER (SHIPS WITH SUPPLY CORPS OFFICERS)				
Any remarks should be placed on the reverse side of this form.						

Figure 3-1.—Preparation of NAVSUP Form 1358.

the remainder of the accounting period. This is the only situation when a fractional return is required upon the relief of an accountable FSO.

Delay and Delinquency

When returns cannot be submitted on or before the date they are required to be submitted, a letter/message from the commanding officer explaining the reason for the delay and the anticipated mailing date is to be forwarded to NAVFSSO before the normal submission date. A copy of the letter is forwarded to the administrative/area/type commander via the military chain of command.

Merged Returns

To reduce the administrative work involved in preparing returns, a GM may merge returns of a

shortened accounting period of 31 days or less with the previous or following accounting period, except at the end of the fiscal year. For example, a ship or activity being disestablished on January 15 may merge that period with the return rendered for October 1 through December 31. Merged returns must be approved in writing by the commanding officer. NAVFSSO (code F) should be notified as soon as possible. The letter of notification should include the reason(s) for the merged returns. No GM returns are merged between 2 fiscal years unless specifically authorized by NAVFSSO.

Temporary Closure

The GMs that are temporarily closed for overhaul, remodeling, or renovation should continue to render monthly reports and quarterly returns in the usual manner, reporting any receipts, expenditures, or surveys. For example, if the GM continues to support

private messes, such transactions must be reported. However, in this case, all losses by survey and inventory are charged as sales to the private mess being supported. If no transactions are conducted by a temporarily closed GM, the monthly NAVSUP Form 1357 must be marked appropriately, GM closed on (date) _____ for (ROH/renovation/and so forth). Expected reopening date is (date) _____. If the reopening date is delayed, NAVFSSO (code F) must be notified.

Final Returns

When returns are no longer required because of deactivation or decommissioning, the final NAVSUP Form 1358 must be marked Final Returns-Decommissioned in red in the body of the Balance Sheet section. The Balance On Hand entry on the NAVSUP Form 1358 is left blank. Transferred stock balances are included in entries opposite the captions Transfers With Reimbursement or Transfers Without Reimbursement, as appropriate, and substantiated with transfer documents.

Combined Returns

When a combined NAVSUP Form 1358 is rendered for a group of ships or for two or more messes ashore with 25 persons or less, each operating a separate GM, a separate monetary allowance must be taken. The value is computed individually for each mess on the reverse of the NAVSUP Form 1358. The values will be totaled and posted to the Total Allowances block on the front of the NAVSUP Form 1358. The Computation of Allowances/Financial Statement section is noticeably marked See Reverse.

RETENTION OF RECORDS AND DOCUMENTS

The FSO maintains files of accounting records and substantiating documents required for audits of subsistence, supply, and GM operation. Records and documents should be retained and disposed of according to the *Navy and Marine Corps Records Disposition Manual*, SECNAVINST 5212.5.

The following original records and documents are retained:

- Subsistence Ledger, NAVSUP Form 335
- Record of Receipts and Expenditures, NAVSUP Form 367

- Food-Item Report/Master Food Code List, NAVSUP Form 1059, and/or Food-Item Request/Issue Document, NAVSUP Form 1282 (when used as issue documents supporting issues to a GM)

- Food-Item Report/Master Food Code List, NAVSUP Form 1059, and Food-Item Request/Issue Document, NAVSUP Form 1282 (when used as issue documents supporting sales to private messes and GMs)

- Food-Item Code/Master Food Code List, NAVSUP Form 1059, or Food-Item Request/Issue Document, NAVSUP Form 1282 (when used as inventory quantity adjustment sheets)

- Special Meal Request/Receipt, NAVSUP Form 340

- Monthly Recapitulation of Meal Record, NAVSUP Form 1292

- Ration and Sales Report, NAVSUP Form 1357

- Food-Preparation Worksheet, NAVSUP Form 1090

- Cash Meal Payment Book, DD Form 1544

- Copies of the following documents are retained:

- General Mess Operating Statement, NAVSUP Form 1358.

- Food-Item Report/Master Food Code List, NAVSUP Form 1059 (when used to summarize issues to the GM at the end of the quarter).

- Each receipt document for the accounting period stapled to an adding machine tape confirming the total.

- Each expenditure document for the accounting period for which an original is not retained. All expenditure documents are stapled to an adding machine tape confirming the total.

- Special Meals Report, NAVSUP Form 1340.

- Expenditure Log (Loss Without Survey), NAVSUP Form 1334.

- Report of Survey, DD Form 200.

RECORDS AND REPORTS IN A PRIVATE MESS AFLOAT

The extent to which the records are maintained in private messes afloat and their complexity are determined largely by the commanding officer and the mess treasurer. Small messes generally have fewer

records than larger messes, simply because they have fewer transactions to record. However, records must be maintained in all afloat private messes, even the very smallest, so that the mess treasurer can easily and quickly determine the financial condition of the mess.

The records, reports, and procedures explained are most common to most private messes afloat. Additional records may be required by the private mess treasurer or the commanding officer. Private messes afloat include the following types: flag officers' messes, unit commanders' messes, commanding officers' messes, wardroom messes, warrant officers' messes, and chief petty officers' messes.

FINANCIAL RECORDS

Keep in mind that all financial transactions affecting a mess must be supported by the proper documents. The omission of a single transaction will make it impossible for the mess treasurer to balance the accounts or to prepare the reports properly.

Financial transactions are supported by documents or vouchers that support receipts and expenditures for which the mess treasurer is responsible. As a Mess Management Specialist (MS) assigned to a private mess, you will be directly or indirectly involved in the financial transaction of the mess; therefore, you must be familiar with the various vouchers and documents that support receipts and expenditures of private messes afloat. All mess records must be retained for a period of 3 years.

PROCUREMENT DOCUMENTS

Most items consumed by private messes afloat are procured from the supply department. Therefore, the greatest number of procurement documents are requisitions to the supply department for food items from the GM.

Messes afloat may also purchase items from approved commercial sources. The methods by which items are purchased may vary, depending on the particular mess. But, whatever the method, the transactions must be supported by the proper documents.

All documents authorizing purchases paid for with mess funds must be signed by the treasurer or someone authorized in writing by the mess treasurer to incur indebtedness in the name of the mess.

Purchases From the General Mess

All food items purchased directly from the GM are supported by a NAVSUP Form 1282. The GM representative and the MS assigned as the issuing storeroom storekeeper should sign for the receipt and issue of the provisions respectively.

Purchases From Commercial Sources

Purchases from approved commercial sources are supported by purchase orders, dealers' invoices, or cash register receipts. Purchase orders should be issued for all purchases from approved commercial sources, including cash purchases authorized by the mess treasurer. A Purchase Order, NAVCOMPT Form 2213, or a locally prepared form may be used. The form must be prenumbered by the mess treasurer or an authorized representative. The original is sent to the dealer, and the copies are distributed and filed as directed by the mess treasurer. The dealer's invoice that accompanies deliveries must be checked against and attached to the applicable purchase order.

Cash purchases are supported by cash register receipts or an itemized receipt bill. If a cashbook or market book is maintained by the leading MS, all entries must be supported by receipts or receipted bills.

BILLING FROM THE GENERAL MESS

On or before the 5th day of the month the FSO prepares a bill for the amount due for food items (including galley-produced bakery products) issued to a private mess during the previous month. The FSO uses the following format: "I certify that the food items in the amount of \$400 (or actual amount for your mess) were sold to the wardroom mess during the month of April 1991."

When galley-produced bakery products are received during the month the bill includes this statement: "The \$400 total includes galley-produced bakery products in the amount of \$25.60." Applicable issue document numbers are listed on the bill.

Within 15 days following the month in which items were purchased, the mess treasurer must pay the amount due to the FSO and obtain a signature for receipt of the cash in a Cash Receipt Book, NAVSUP Form 470.

COMMUTED RATIONS/BASIC ALLOWANCE FOR SUBSISTENCE

The term *commuted rations/basic allowance for subsistence* (BAS) is defined as a cash allowance payable to enlisted personnel who are permitted to mess separately in lieu of rations-in-kind when messing facilities are available.

Each month the mess treasurer submits a list of enlisted personnel subsisted in the mess on a locally prepared form in triplicate to the disbursing officer. The form will show the social security number, name, and period subsisted if different than that stated for the period reported for each member whose rations are being commuted.

On the basis of the information furnished on the locally prepared form, the disbursing officer prepares a Public Voucher, Standard Form 1034, that supports payment of enlisted personnel commuted rations to the mess.

Rations commuted to the private mess are used only for subsisting the enlisted personnel. Commuted rations are not to be used in any manner whatsoever to support members' mess bills, increase the value of mess shares, or any other mess operation except the direct cost of feeding the enlisted personnel whose rations are commuted to the mess.

CASH RECEIPTS

Prenumbered receipts, issued in numerical sequence, must be given for each payment of any kind being received by a mess account. When prenumbered receipts are not currently available in the supply system they are to be procured locally. Plain receipts maybe prenumbered using a numbering machine; however, if this method is used, the numbering machine and all unnumbered receipts must be in the custody of a person not receiving cash into the mess account. Duplicate copies are to be retained by the mess treasurer for 3 years, and each numbered receipt must be accounted for. A receipt should be obtained from each member at the time a mess rebate is paid to the individual.

Normally, a safe is provided for the mess treasurer. when provided, it should be located in a place where adequate security can be maintained. If a safe is not available, the funds must be placed with the disbursing officer for safekeeping.

When practical, messes should establish bank accounts. Normally, the maximum amount of cash funds that the mess treasurer is authorized to have on

hand is established by the commanding officer. A separate bank account should be established for each mess aboard ship. Joint accounts are prohibited.

When petty cash funds are provided to an MS or a mess member to make purchases for the mess, a memorandum cash receipt must be issued and maintained by the mess treasurer as cash on hand. This receipt is held until it is replaced by a cash register tape receipt or similar type of document that substantiates the expenditure and any cash change totaling the entire amount of the funds issued.

Checks and Bank Statements

Canceled checks support payments for purchases and other expenditures of the mess. They must be retained and filed so as to be readily available to auditing and inspecting officers. Bank balances support entries of cash assets in mess accounts.

Control of Safe Combinations

Every person responsible for mess funds must be provided with a safe or a separate locked compartment in a large safe. The rules in the *Navy Comptroller Manual*, volume 4, are applicable. One important rule is that the responsible individual is not to reveal the combination of the safe to any person. Placing the combination in a sealed envelope to be kept in the custody of the commanding officer or any other officer is prohibited. Safe combinations must be changed every 6 months and whenever a new custodian takes over.

Control of Keys

To pinpoint responsibility, it is essential that only one person has an active key to any storerooms or other secured spaces. If considered necessary, a duplicate key may be placed in a sealed envelope in the mess treasurers's safe or inside a glass-fronted, locked cupboard. In the absence of the custodian for a particular store or storage space, emergency entrance may be accomplished by the mess treasurer who should open the storeroom or space in the presence of two witnesses. After entry, the space is to be sealed, in the presence of the two witnesses, until the custodian returns.

INVENTORIES

All provisions on hand that have been procured from mess funds are inventoried on the last day of each month. The inventory is taken by the mess treasurer and

and expenditures of the mess from which the financial condition of the mess can be determined at any time. The treasurer must submit a statement of the accounts of the mess to the commanding officer at the end of the month. The statement must show in detail the money owed by or to the mess, mess receipts and expenditures, and any contracts entered into for future deliveries of supplies.

The *Nonappropriated Fund Accounting Procedures*, NAVSO P-3520, prescribes general financial management policies and principles governing nonappropriated fund activities and the applicable portions governing the financial management of private messes afloat. Additional local controls may be established if desired.

ACCOUNTING RECORDS

It is necessary to keep accounting records to be able to account for every transaction that has occurred. These records are also used in the preparation of the monthly financial operating statement for messes afloat at the end of the quarter. All mess records are retained for a period of 3 years.

Records of Collections and Expenditures

These records reflect all collections (or receipts) and expenditures of cash and checks. They are not used to record funds due or owed or the dollar value of materials received or expended. See figures 3-2 and 3-3.

RECORD OF EXPENDITURES			FOR MONTH OF JANUARY 1992	
DATE	NAME	AMOUNT	PURPOSE	
4	FOOD SERVICE OFFICER	782 80	DECEMBER 1991 PROVISIONS	
18	PETE'S JEWELRY	25 00	FAREWELL GIFT FOR LTJG METTS	
20	LTJG METTS MESS BILL 30.97 MESS SHARE 44.59	75 56	DETACHED O945, 20 JANUARY 1992	
24	NAVY COMMISSARY STORE	82 78	JANUARY 1992 PROVISIONS	
25	WILFONG'S FISH MARKET	131 08	DECEMBER 1991 PROVISIONS	
	CASH ON HAND AT EOM	1586 64		
	TOTAL	2683 86		

Figure 3-3.—Record of expenditures.

Records of Accounts Payable and Accounts Receivable

These records reflect the monies owed to the mess and the unpaid debts of the mess. These are closed monthly. All unsettled accounts are carried forward to the following month. See figures 3-4 and 3-5.

Records of Mess Members

A record must be maintained of members of the mess by member's name, date of membership, and the amount paid for the membership. Upon redemption of the membership the record should show the date the membership was redeemed and the amount for which it

ACCOUNTS PAYABLE					FOR MONTH OF JANUARY 1992	
DATE INCURRED	NAME OF PAYEE	AMOUNT		PURPOSE	DATE PAID	
1	FOOD SERVICE OFFICER	782	80	DECEMBER 1991 PROVISIONS	4	
1	WILFONG'S FISH MARKET	131	08	DECEMBER 1992 PROVISIONS	29	
8	LCDR LAMBERT	12	90	MESS BILL REBATE - LEAVE 0001, 8 JAN - 0730, 13 JAN	CF	
15	JOE'S PIZZA	98	50	JANUARY 1992 PROVISIONS	CF	
17	LT WALCOTT	15	48	MESS BILL REBATE - TAD 0600, 17 JAN - 0730, 23 JAN	CF	
18	PETE'S JEWELRY	25	00	FAREWELL GIFT FOR LTJG METTS	18	
18	LCDR MCCARY	75	00	FEBRUARY 1992 MESS BILL PAID IN ADVANCE	CF	
20	LEROY'S DELI	127	84	JANUARY 1992 PROVISIONS	CF	
20	LTJG METTS	MESS BILL 30.92 MESS SHARE 44.59	75 56	DETACHED 0945, 20 JANUARY 1992	20	
24	NAVY COMMISSARY STORE	82	78	JANUARY 1992 PROVISIONS	24	
31	FOOD SERVICE OFFICER	1095	88	JANUARY 1992 PROVISIONS	CF	
31	LTJG HAMMER	MESS SHARE 44.59	44 59	DETACHED 1930, 31 JANUARY 1992	CF	

On the first day of the month, list all unpaid Accounts Payable brought forward from the previous month. At the end of the month, all unpaid Accounts Payable will be carried forward to the next month's report. Mark CF (carried forward) in Date Paid column.

Figure 3-4.—Record of accounts payable.

ACCOUNTS RECEIVABLE

FOR MONTH OF JANUARY 1992

DATE INCURRED	NAME	AMOUNT	PURPOSE	DATE RECD
1	DISBURSING OFFICER	220 00	DECEMBER 1991 COMMUTED RATIONS	11
1	LCDR SLOUGH	75 00	DECEMBER 1991 MESS BILL	12
1	LTJG HAMMER	80 00	JANUARY 1992 MESS BILL	6
1	LCDR SIMS	80 00	JANUARY 1992 MESS BILL	4
1	LT DOYLE	80 00	JANUARY 1992 MESS BILL	5
1	ENS SMITH	80 00	JANUARY 1992 MESS BILL	7
1	LTJG JAMES	80 00	JANUARY 1992 MESS BILL	6
1	LCDR SLOUGH	80 00	JANUARY 1992 MESS BILL	12
1	LTJG HAYES	80 00	JANUARY 1992 MESS BILL	6
1	ENS BAKER	80 00	JANUARY 1992 MESS BILL	CF
1	ENS ALLEN	80 00	JANUARY 1992 MESS BILL	7
1	CDR JONES	80 00	JANUARY 1992 MESS BILL	4
1	LT WALCOTT	80 00	JANUARY 1992 MESS BILL	4
1	LTJG METTS	80 00	JANUARY 1992 MESS BILL	6
1	ENS SNYDER	80 00	JANUARY 1992 MESS BILL	7
1	ENS RICHEY	80 00	JANUARY 1992 MESS BILL	7
1	LTJG DOFF	80 00	JANUARY 1992 MESS BILL	6
1	LCDR LAMBERT	80 00	JANUARY 1992 MESS BILL	4
1	LCDR MCCARY	80 00	JANUARY 1992 MESS BILL	18
10	LT ROBINSON	MESS BILL 56.77 MESS SHARE 44.59	ARRIVED 1300, 10 JANUARY 1992	CF
15	CDR MCGEE	MESS BILL 43.87 MESS SHARE 44.59	ARRIVED 1300, 15 JANUARY 1992	15
18	LCDR MCCARY	75 00	ESTIMATED FEBRUARY 1992 MESS BILL PAID IN ADVANCE	18
31	DISBURSING OFFICER	309 96	JANUARY 1992 COMMUTED RATIONS	CF

On the first day of the month, list all uncollected Accounts Receivable brought forward from the previous month. Also, list names of all current mess members. At the end of the month, all uncollected Accounts Receivable will be carried forward to the next month's report. Mark CF (carried forward) in Date Received column.

Figure 3-5.—Record of accounts receivable.

was redeemed. A locally prepared form may be used for this purpose. See figure 3-6.

Petty Cash Vouchers

When needed, the commanding officer can authorize in writing the establishment of a petty cash fund. The authorization specifies the amount of cash

authorized for the petty cash fund. Payments setting up petty cash funds and the replenishment of such funds are made by check or cash transfer voucher if the mess does not have a checking account. The replenishment of petty cash funds must be substantiated by a signed Petty Cash Voucher, NAVCOMPT Form 743, and by the dealer's sales slip or receipt. An example of a petty cash voucher is shown in figure 3-7.

RECORDS OF MESS MEMBERS

MEMBER	DATE JOINED	SHARE		DATE DETACHED	SHARE	
LTJG HAMMER	2 SEP 88	36	01	31 JAN 92	44	59
LTJG GULF	5 SEP 88	36	01	14 MAR 90	43	17
ENS HOFFMAN	21 OCT 88	37	99	16 OCT 90	41	05
LCDR SIMS	16 NOV 88	38	19			
LT SUMNER	20 NOV 88	38	19	15 DEC 90	42	79
LT FLAGG	22 JAN 89	38	75	20 DEC 90	42	79
LT DOYLE	1 MAR 89	40	76			
ENS SMITH	3 MAR 89	40	76			
LTJG JAMES	14 APR 89	38	90			
ENS WELTER	13 MAY 89	39	06	21 JAN 91	43	81
LCDR SLOUGH	29 MAY 89	39	06			
LT LINGARD	6 JUL 89	39	95	20 MAR 91	43	17
LTJG HAYES	30 JUL 89	39	95			
ENS BAKER	10 OCT 89	41	05			
ENS ALLEN	13 OCT 89	41	05			
CDR JONES	10 NOV 89	42	96			
LT WALCOTT	29 DEC 89	42	79			
LTJG METTS	4 JAN 90	43	81	20 JAN 92	44	59
ENS SNYDER	16 MAY 90	42	19			
ENS RICHEY	2 AUG 90	43	75			
LTJG DOFF	17 NOV 90	43	75			
LCDR LAMBERT	20 MAY 91	42	63			
LCDR MCCARY	7 SEP 91	43	67			
LT ROBINSON	10 JAN 92	44	59			
CDR MCGEE	15 JAN 92	44	59			

Figure 3-6.—Records of mess members.

Food Cost Control Record

Often messes afloat operate without the benefit of a central storeroom where provisions are received and stored before issue to the private mess or wardroom galley. Since messes afloat have limited storage

facilities, most food used is requisitioned from the GM on a regular basis. Food procurement records are limited generally to those covering receipts of subsistence items from the GM. This simplifies food cost accounting and consequently, food cost control. The use of the food cost control record is optional for

<div style="border: 1px solid black; padding: 2px; display: inline-block;">PRENUMBERED BY THE MESS</div>	
PETTY CASH VOUCHER <small>NAVCOMPT FORM 743 (7-54)</small>	
NO _____	
AMOUNT	DATE
FOR	
CHARGE TO	
RECEIVED BY	APPROVED BY
<div style="border: 1px solid black; padding: 5px; display: inline-block;">SIGNATURE OF PAYEE</div>	<div style="border: 1px solid black; padding: 5px; display: inline-block;">APPROVED BY MESS TREASURER</div>

Figure 3-7.—Petty cash voucher.

messes with less than 20 members. An example of a food cost control record is shown in figure 3-8.

Meals Served Record Sheet

This record reflects a summary of all meals that were consumed in the mess, broken down by category (officers, enlisted, or guests), and further broken down by breakfast, lunch, and dinner. The document used to support these figures is the Sale of General Mess Meals, NAVSUP Form 1046, that is used to record meal consumption. This record will be used in the preparation of the Computation of Commuted Rations form. An example of a meals served record sheet is shown in figure 3-9.

Monthly Voucher Folders

All private mess itemized and certified receipts and tapes of provisions purchased locally, copies of vouchers covering transactions with the disbursing officer, and any other vouchers substantiating entries on the mess statement will be filed in monthly voucher folders. These folders are submitted to the audit board and eventually retained by the mess treasurer.

PREPARATION OF MONTHLY FINANCIAL OPERATING STATEMENT

The mess treasurer is responsible for the preparation of the monthly financial operating statement consisting of a cash account that shows cash received (income) and cash spent (expenses), and a balance sheet that shows the financial condition of the mess and provides useful

FOOD COST CONTROL RECORD
FOR MONTH OF JANUARY 1992

BEGINNING INVENTORY \$ 102.40

DATE (1)	RECEIPTS		CLOSING INVENTORY (4)	COST OF FOOD USED TO DATE (5)	ALLOWANCE		OVER/UNDER (8)
	DAILY (2)	CUMULATIVE TOTAL (3)			DAILY (6)	CUMULATIVE TOTAL (7)	
1	42 50	42 50			66 00	66 00	
2	67 69	110 19			66 00	132 00	
3	38 92	145 11			66 00	198 00	
4	21 46	170 57			66 00	264 00	
5	18 49	189 06			66 00	330 00	
6	25 09	214 15			66 00	396 00	
7	8 88	223 03	85 63	239 80	66 00	462 00	222 20
8	22 24	245 27			66 00	528 00	
9	52 14	297 41			66 00	594 00	
10	11 15	308 56			66 00	660 00	
11	19 02	327 58			66 00	726 00	
12	87 77	415 35			66 00	792 00	
13	35 00	450 35			66 00	858 00	
14	36 18	486 53	32 16	556 77	66 00	924 00	367 23
15	98 50	585 03			66 00	990 00	
16	25 12	610 15			66 00	1056 00	
17	59 56	669 71			66 00	1122 00	
18	38 50	708 21			66 00	1188 00	
19	10 08	718 29			66 00	1254 00	
20	127 84	846 13			66 00	1320 00	
21	29 09	875 22	28 37	949 25	66 00	1386 00	436 75
22	42 62	917 84			66 00	1452 00	
23	45 00	962 84			66 00	1518 00	
24	82 78	1045 62			66 00	1584 00	
25	27 84	1073 46			66 00	1650 00	
26	57 53	1130 99			66 00	1716 00	
27	52 47	1183 46			66 00	1782 00	
28	58 00	1241 46	36 84	1307 02	66 00	1848 00	540 98
29	43 73	1285 19			66 00	1914 00	
30	52 78	1337 97			66 00	1980 00	
31	67 03	1405 00	123 63	1383 77	66 00	2046 00	662 23

Figure 3-8.—Food cost control record.

statistical data for the operation of the mess, using the Monthly Financial Operating Statement for Messes Afloat, NAVSUP Form 1367. See figure 3-10. An original and one copy are prepared as of the last day of the month that the mess was in operation. The original must be signed by the mess treasurer, the audit board, and the commanding officer. Then the original should be returned to the mess treasurer for his or her records.

For more information on the preparation of the NAVSUP Form 1367, see the NAVSUP P-486, volume II, chapter 7. Finally, the copy is then posted for the information of all members of the mess.

CREDIT SALES

If the sale of meals from a GM has been authorized and is considered practical, the commanding officer

MEALS SERVED RECORD SHEET

FOR MONTH OF JANUARY 1992

DATE	OFFICERS			ENLISTED			GUEST			DAILY TOTAL
	B	L	D	B	L	D	B	L	D	
1	10	12	10	3	5	4			1	45
2	12	15	10	4	4	3		1	1	50
3	10	14	10	4	5	4				47
4	11	12	11	4	5	3		1	1	48
5	12	15	12	4	5	4				52
6	10	15	10	4	4	3				46
7	11	12	10	3	3	3		1	2	45
8	10	12	9	2	3	2		4	3	45
9	11	14	12	4	5	4				50
10	12	14	11	4	5	5				51
11	15	15	15	5	5	5	4	4	4	72
12	15	15	15	5	5	5	4	4	4	72
13	15	15	15	5	5	2	4	4	4	69
14	11	13	10	2	3	2		2	3	46
15	10	12	11	2	4	2		4	4	49
16	15	15	13	4	4	5				56
17	12	15	12	4	5	4				52
18	12	15	13	4	5	3				52
19	11	15	12	3	5	4				50
20	11	15	10	4	5	4				49
21	10	11	11	2	3	2				39
22	11	14	12	2	2	2		2	3	48
23	10	15	11	4	5	5		1	3	54
24	11	15	12	5	5	4				52
25	12	15	11	4	5	4				51
26	12	15	11	3	4	3				48
27	11	15	12	3	5	4				50
28	16	16	16	5	5	5	2	2	2	69
29	16	16	16	5	5	5	2	2	2	69
30	16	16	16	5	5	5	2	2	2	69
31	14	16	13	5	5	4				57
TOT	375	444	372	117	139	114	18	34	39	1652

Figure 3-9.—Meals served record sheet.

may authorize the sale of meals on a credit basis to officers, enlisted, and the other categories subsisted on a daily basis.

When meals are sold on a credit basis, the Sale of General Mess Meals, NAVSUP Form 1046, is used and

completed by the FSO or at the option of the commanding officer. An MS is assigned the duty of maintaining these NAVSUP Forms 1046. The MS places a check mark or maintains a running total in the appropriate block opposite each name to indicate

MONTHLY FINANCIAL OPERATING STATEMENT FOR MESSSES AFLOAT
 NAVSUP FORM 1247 (REV. 8-78)
 SH-100-1-07-507

USS DUARTE

NAME OF MESS WARDROOM MESS

DATE (LAST DAY OF MONTH) 31 JANUARY 1992

CASH ACCOUNT				BALANCE SHEET			
RECEIPTS		EXPENDITURES		ASSETS		LIABILITIES	
CASH BROUGHT FORWARD	945.40	MESS BILLS REFUNDED	30.97	CASH ON HAND THIS DATE	1586.64	MESS BILL REFUNDS OWED	28.38
MESS BILLS PREVIOUS MONTHS	75.00	MESS SHARES REFUNDED	44.59	MESS BILLS UNCOLLECTED	136.77	MESS SHARE REFUNDS OWED	44.59
MESS BILLS CURRENT MONTH	1323.87	PROVISIONS FROM SUPPLY OFFICER	782.80	MESS SHARES UNCOLLECTED	44.59	PROVISIONS FROM SUPPLY OFF OWED	1095.88
MESS BILLS NEXT MONTH	75.00	PROVISIONS FROM DEALERS	213.86	COMPUTED RATIONS UNCOLLECTED	309.96	PROVISIONS FROM DEALERS OWED	226.34
MESS SHARES SOLD	44.59	COMPUTED RATIONS REBATED	00.00	INVENTORY OF PROVISIONS	123.63	COMPUTED RATIONS REBATED OWED	00.00
COMPUTED RATIONS COLLECTED	220.00	OTHER		OTHER		OTHER	
		PETE'S JEWELRY	25.00			ADV MESS BILL PD	75.00
						TOTAL LIABILITIES	1470.19
		TOTAL EXPENDITURES	1097.22			TOTAL ASSETS	2201.59
		CASH ON HAND END OF MONTH	1586.64			T. LIABILITIES	1470.19
						NET WORTH	731.40
TOTAL	2683.86	TOTAL	2683.86	TOTAL ASSETS	2201.59	TOTAL LIABILITIES AND NET WORTH	2201.59
MESS SHARE		PROVISIONS CONSUMED		COST PER MAN			
NET WORTH	731.40	INVENTORY END OF PREVIOUS MONTH	102.40	AVERAGE NUMBER OF OFFICERS SUBSISTED	13.78		
NUMBER OF MEMBERS	17	PROVISIONS RECEIVED	1405.00	AVERAGE NUMBER OF ENLISTED PERSONNEL SUBSISTED	3.98		
MESS SHARE END OF MONTH	43.02	INVENTORY END OF MONTH	123.63	TOTAL SUBSISTED	17.76		
MESS SHARE END OF PREVIOUS MONTH	44.59	PROVISIONS CONSUMED	1383.77	PROVISIONS CONSUMED	1383.77		
INCREASE/DECREASE	1.57			COST PER MAN	77.91		
RECOMMENDED MESS BILL FOR NEXT MONTH							84.00

Accounts Receivable (number of members and amounts owed to the mess) are based on the reverse side.
 Accounts Payable (names of persons and amounts owed by the mess) are based on the reverse side.
 I certify the foregoing statement to be correct that the provisions shown on the attached inventory are in good condition and carried at their proper value and that the mess has no assets or liabilities other than those listed.

5 FEB 92
 (Date)
 ATTESTED BY: [Signature]
 JAMES, LTJG, USN
 (Member)
 APPROVED BY: [Signature]
 7 FEB 92
 (Date)

[Signature]
 A. B. SNYDER, ENS, USN
 (Treasurer)
[Signature]
 JAMES, LTJG, USN
 (Member)
[Signature]
 LAMBERT, LCDR, SC, USN
 (Commanding Officer)
[Signature]
 J. P. JONES, CDR, USN
 (Commanding Officer)

Figure 3-10.—Monthly financial operating statement for messes afloat.

consumption of meals. See figure 3-11 as an example. The form is posted in a noticeable location where it can be inspected visually by private mess members. At the end of each month, each member signs in the Name block to acknowledge approval of the meal tally.

Payment for all meals sold on a credit basis is required no later than 15 days following the end of the month in which the meals were sold. Individuals

concerned are to make payment before detachment. The FSO furnishes a receipt for the cash paid. The Cash Receipt Certificate, NAVCOMPT Form 2114, may be used by marking out the line "for which I hold myself accountable to the Treasurer of the United States of America." Collections for unpaid bills due to death, transfer, and refusal to pay are made according to the *Navy Comptroller Manual*.

SALE OF ENLISTED DINING FACILITY MEALS

NAME	MEAL	MONTH: JANUARY YEAR: 1993																															TOTAL SALES			RATE	VALUES	TOTAL VALUE
		1	2	3	4	5	6	7	8	9	10	11	12	13	14	15	16	17	18	19	20	21	22	23	24	25	26	27	28	29	30	31	B	L	D			
ERIC T. HOLMES LT, USN <i>Eric T. Holmes</i>	B						X	X	X						X										X	X			X	X			18		95	17.10		
	L						X	X	X						X										X	X			X	X			17		190	32.30		
	D								X	X															X	X							14		190	26.60		
TOM B. REMELY LT, USN <i>Tom B. Remely</i>	B						X								X	X									X	X							17		95	16.15		
	L						X								X	X									X	X			X	X			23		190	43.70		
	D								X									X							X									13		190	24.70	
DOUG R. FREESMAN LT, USN <i>Doug R. Freeman</i>	B						X	X							X																			15		95	14.25	
	L						X	X	X						X	X																		18		190	34.20	
	D							X	X									X	X	X														17		190	32.30	
SEAN K. O'KEEFE LTJG, USN <i>Sean K. O'Keefe</i>	B						X								X	X																		16		95	15.20	
	L						X								X	X	X														X			18		190	34.20	
	D								X									X																	13		190	24.70
MIKE A. MORLEY LTJG, USN <i>Mike Morley</i>	B	AT SEA	AT SEA	AT SEA	AT SEA	AT SEA	X	X							X																			17		95	16.15	
	L	AT SEA	AT SEA	AT SEA	AT SEA	AT SEA	X	X	X						X	X																			17		190	32.30
	D	AT SEA	AT SEA	AT SEA	AT SEA	AT SEA	X	X							X																				13		190	24.70
WILLIAM B. ELLIS ENS, SC, USN <i>W.B. Ellis</i>	B	AT SEA	AT SEA	AT SEA	AT SEA	AT SEA	X	X							X																				13		95	12.35
	L	AT SEA	AT SEA	AT SEA	AT SEA	AT SEA	X	X	X						X	X																			16		190	30.40
	D	AT SEA	AT SEA	AT SEA	AT SEA	AT SEA	X								X																				12		190	22.80
BILL C. LANSFORD ENS, USN <i>Bill Lansford</i>	B						X								X																				15		95	14.25
	L						X	X	X						X	X																			23		190	43.70
	D								X									X	X	X															15		190	28.50
CASH SALES	B																																		111		95	105.45
	L																																		132		190	250.80
	D																																			97		190
		TOTALS																															323	281	353			

I CERTIFY THAT THE ABOVE TOTALS REPRESENT MEALS CONSUMED IN THE MESSES AND THAT THE AMOUNTS HAVE BEEN COLLECTED THIS DATE AS INDICATED ABOVE. *W.B. Ellis, Ens, SC, USN* 2/5/93 113.8 540.55

Figure 3-11.—Preparation of Sale of General Mess Meals, NAVSUP Form 1046.

COMPUTATIONAL PROCEDURES FOR DETERMINING THE COST OF SUBSISTENCE IN MESSES AFLOAT

At the end of the month, a comparison of the total value of ration allowances that are commuted to the mess with the value of the provisions consumed by the enlisted personnel is required. This is necessary to determine the commuted ration amount payable to the mess. The value of the provisions consumed by the enlisted personnel is computed by determining the percentage of all meals served in the mess that were eaten by the enlisted personnel and multiplying the total value of the provisions consumed by this percentage. When the value of the total commuted ration allowance exceeds the value of the total provisions consumed by the enlisted personnel, the monetary difference is to be credited to the Operation and Maintenance, Navy (O&M,N) fund code.

DETERMINATION OF MEALS SERVED

Messes must establish a method whereby the total number of meals served is categorically recorded daily. This includes meals served to mess members, guests of the mess, and the number of meals eaten by enlisted personnel. To get the total percentage of meals consumed by each category, divide the number of meals consumed by the enlisted personnel by the total number of meals served; for example:

- Mess member and guest meals784
- Enlisted personnel meals403
- Total meals served1,187

Dividing 403 by 1,187 = 33.9%, which is the percentage of meals eaten by enlisted personnel.

DETERMINATION OF VALUE OF PROVISIONS CONSUMED

Determine the total value of provisions consumed by subtracting the money value of the closing inventory

from the sum of the opening inventory and the total receipts during the month; for example:

Opening inventory value	\$50.00
Plus value of receipts	<u>+410.00</u>
Total	460.00
Minus value of closing inventory	<u>-40.00</u>
Value of provisions consumed	420.00

COMPARISON

Multiply the value of provisions consumed by the enlisted personnel meal percentage and compare the product with the value of the total commuted rations. The amount payable to the mess is the lesser of the two amounts; for example:

Provisions consumed	\$420.00
Enlisted personnel meal percentage	<u>x33.9%</u>
1. Cost of provisions for enlisted personnel ...	\$142.38
2. Enlisted total commuted rations value	\$214.42

Thus, the lesser amount of 1 and 2 is (\$142.38 in this case) paid to the mess treasurer by the disbursing officer.

COMPUTATION OF A PARTIAL MESS BILL FOR A NEW MEMBER BEING PERMANENTLY ASSIGNED

Members are charged for the day they report aboard unless reporting after 1800. Multiply the actual number of inclusive days for which a mess bill is payable (all days of the month that the member is aboard including the 31st day, when applicable) by the month's mess bill, then divide by the actual number of days in the month and round off to the nearest cent; for example:

Member reports for duty at 0900 12 August.

Mess bill for August is \$45.00.

Inclusive dates chargeable: 12-31 August (20 days).

20 x \$45.00 = \$900.00.

$\frac{\$900.00}{31} = \29.03 (charge due plus September's mess share).

MESS BILL REBATE FOR MEMBER BEING PERMANETLY DETACHED

Members are not charged for the day they depart unless they depart after 1800; for example:

Member being detached at 1200 22 April.

Mess bill for April is \$42.00, which the member paid on 3/30.

Inclusive dates not chargeable: 22-30 April (9 days).

9 x \$42.00 = \$378.00.

\$378.00

$\frac{\$378.00}{30} = \12.60 (rebate due)

To summarize rebate rules from previous paragraphs, there is no charge for the day of departure if the member leaves before 1800 and no charge for the day a member arrives if he or she arrives after 1800. Otherwise either day is charged.

MESS BILL REBATE FOR MEMBER ON TAD

Compute the actual mess bill rebate by determining the inclusive number of days the member is not eating in the mess; for example:

Member goes on TAD at 0800 on 5 February to 1630 on 9 February.

Mess bill for February is \$47.00, which member paid on 1/30.

Inclusive dates not chargeable: 5 through 8 February (4 days).

4 x \$47.00 = \$188.00.

$\frac{\$188.00}{28} = \$6.714 = \$6.71$ (rebate due).

No mess share rebate is given for 9 February since the member has returned to the mess before the time of the evening meal (1800).

MESS BILL REBATE FOR MEMBER ON LEAVE

The day of departure on leave is counted as a day of duty. However, for mess purposes this day is the first day of absence if the member does not eat any meals in the mess on that day. If a member returns before 1800, the day before the day of return is the last day of the

absence. When a member goes on leave, he or she is entitled to a mess bill rebate for the entire period of absence; for example:

Member is on leave from 0001 on 20 June to 0730 on 5 July.

Mess bill for June is \$51.00, which member paid on 5/30.

Mess bill for July is \$48.00.

Period of absence: 6/20 to 7/4 (inclusive days).

Rebate for June.

Inclusive dates not chargeable: 6/20 to 6/30 (11 days).

$$11 \times \$51.00 = \$561.00.$$

$$\frac{\$561.00}{30} = \$18.70.$$

Rebate for July.

Inclusive dates not chargeable: 7/1 to 7/4 (4 days).

$$4 \times \$48.00 = \$192.00.$$

$$\frac{\$192.00}{31} = \$6.19.$$

$$\$18.70 + \$6.19 = \$24.89 \text{ (total rebate due).}$$

Mess bill for July: \$48.00

Rebate due: -\$24.89

Net mess bill owed

for month of July: \$23.11

CHAPTER 4

FOODSERVICE EQUIPMENT

The foodservice equipment located in the galley and dining areas at naval shore stations and aboard Navy ships is designed specifically for serving large quantities of food. To make sure of the safe, sanitary, and efficient operation of this equipment, it must be maintained in proper working order and used correctly.

GENERAL PRECAUTIONS

Before attempting to operate any foodservice equipment, you should observe the following general precautions:

- Check for and determine the location of emergency materials such as fire extinguishers, emergency switches, first aid boxes, and telephone emergency numbers to make sure they are available should an accident occur. Report any deficiencies or malfunctioning materials to the supervisor.
- Make sure the area around the equipment is clear of obstructions and thoroughly dry. All spills must be cleaned up immediately to ensure a clean, dry, nonslippery working surface.
- Make sure the working area has ample lighting.
- If there is any doubt about the operating procedures or safety precautions, report to the supervisor.
- No unauthorized personnel should attempt to operate equipment in any foodservice space.
- Be certain no loose gear is in the vicinity of moving parts of machines. Before starting, you should make sure all safety guards, screens, and devices are in place.
- When operating a machine, you should make sure you maintain a safe distance from all moving parts. Never use your hands or body to stop moving blades and parts even though power has been turned off.
- Never lean against a machine while it is operating.
- If ship movement is severe, exercise caution; if severe movement continues, nonessential machine operation should be discontinued and equipment turned off.
- Use safety equipment such as rubber protective gloves, safety goggles, and dip baskets while handling chemicals or hot water. Consult the material safety data sheets (MSDSs) for additional precautions before using cleaners and detergents.
- Keep your hands, body, and clothing away from moving machine parts.
- Never leave moving machinery unattended.
- Do not distract the attention of personnel who are operating the machines.
- Do not attempt to clean or service a machine while it is in operation. Before cleaning, adjusting, oiling, greasing, and so forth, you should be sure the power is turned off and the equipment is de-energized and properly tagged out of service.
- All repairs, tag-outs, and servicing should be made only by authorized personnel.
- Make sure safety devices such as safety interlocks on covers of vegetable peelers and bread slicer safety cutoffs are maintained in proper working condition at all times. If removed for any reason, such devices must be replaced before the machine is put into operation.
- Remove rings and watches and eliminate any loose clothing such as unbuttoned sleeve cuffs, oversized gloves, and ill-fitting coats or jackets.
- Make sure all permanently mounted equipments are hardwired.
- Make sure any rubber safety covers over electrical switches are in place and have no holes or cracks.

TYPES OF EQUIPMENT

Foodservice equipment is used for the cooking and preparation of food and the cleaning of utensils and dinnerware. This consists of all equipment located in foodservice spaces like the general mess (GM),

bakeshop, meat preparation room, private mess galleys, dining areas, and sculleries.

Numerous items of foodservice equipment such as vegetable peelers, meat choppers, dough mixers, and refrigerators are either driven by electric motors or are heated electrically (such as ranges, broilers, griddles, and fry kettles). Safety precautions must be observed around all electrical equipment to avoid injury from shock. Major cleaning requires the equipment to be tagged out according to the tag-out bill.

Negligence in carrying out routine operating instructions and preventive maintenance introduces an undue health hazard among the people served. Therefore, it is vital that the correct operating procedures be followed, that a cleaning schedule be carefully adhered to, and that the machine be given adequate preventive maintenance to make sure of satisfactory cleaning and sanitizing of eating utensils.

It is necessary to know all the foodservice equipment needed, whether it is for cooking, serving, cleaning, mixing, cutting, or storing. Understanding their basic operation and cleaning is a must for every foodservice personnel. For more detailed coverage of foodservice equipments, refer to *Foodservice Operations*, NAVSUP P-421, appendix B.

STEAM-JACKETED KETTLES

There are two different types of steam-jacketed kettles in use afloat as well as ashore. It is important to know which type your command uses. The following are basic principles to follow for each type of kettle:

- Steam-jacketed kettle (steam supplied): Steam is supplied to foodservice spaces for the use of the steam-jacketed kettles. The foodservice division is required to make sure the operating procedures are closely monitored; the steam kettle can become a potential lethal instrument. To make sure the kettle is maintained properly, follow the required planned maintenance system (PMS) cards and operating instructions.

- Steam-jacketed kettle (electric): Steam is internally supplied through a sealed "vacuum" system. It is the responsibility of the galley watch captain to make sure the level of water does not go below the minimum level on the sight glass. To recharge the system you must add distilled water obtained from either the ship's distilling plant or from sources of supply. If tap water is used, it can cause a buildup of mineral

deposits on the heating coils and decrease the effectiveness of the kettles.

Steam-jacketed kettles are used to prepare a variety of food items such as soups, sauces, vegetables, meat, and beverages. This equipment is very important and should be handled with great care (fig. 4-1). The kettles vary in size from 5 to 80 gallons. Approximately the lower two-thirds of each kettle is surrounded by a jacket that is offset from the main kettle body to provide space for steam to circulate and heat the contents of the kettle. The kettles are permanently mounted on a pedestal or three legs and have a hinged lid or cover. They also have a tube at the bottom of the kettle with a faucet at the outer end for drawing liquids instead of dipping them out, and a steam inlet connection, a steam outlet connection, and a safety valve. Some steam-jacketed kettles (or trunnions) have a handle on the side making it possible to tilt the kettle and pour contents into a service container. This type of kettle is usually used to prepare gravies and sauces. Kettles now in use are made of three types of material: corrosion-resisting steel, aluminum, and single-clad corrosion-resisting steel. Never fill the kettle completely full. When the lid is closed while cooking, make sure you are extremely careful in opening the lid because hot steam trapped in the kettle could burst out and cause a serious injury. If it is necessary to stir the contents, use a metal paddle; never leave the paddle in the kettle while cooking.

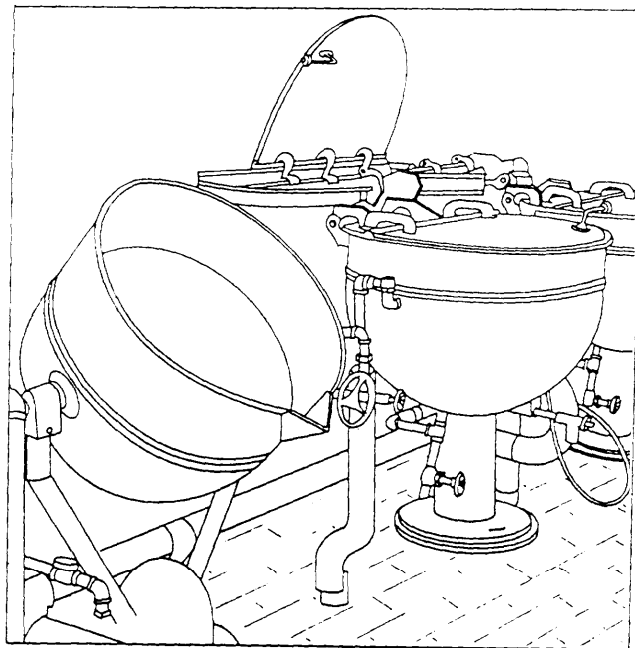

Figure 4-1.—Steam-Jacketed kettles.

Operation

The kettles are constructed to operate on a maximum steam pressure of 45 pounds per square inch. When the pressure in the galley steam line exceeds 45 psi, a pressure regulating valve (safety valve) installed in the steam line leading to the kettles is set to release pressure at 45 psi. Do not tamper with the safety valve or tie it closed. It is there to prevent the kettle from exploding. When operating a cold kettle, turn the steam on gradually, allowing the shell to become thoroughly warm before full pressure is applied. After the shell has become warm, and before applying full pressure, open the safety valve by pulling the lever. Opening the safety valve when enough pressure is within the shell removes air from within the jacket and prevents the kettle from becoming air-bound.

Cleaning

Kettles (or coppers) must be cleaned after each use. General cleaning instructions are as follows:

1. Rinse kettle immediately after cooking. Open draft faucet and flush with water.
2. Soak. Close drain valve. Fill with water above cooking level. If greasy, apply heat. Use a scrub brush to loosen food particles. Drain soak water.
3. Refill and clean. Add detergent, using 1 ounce to 1 gallon of water. Clean interior, hinges, under surfaces of lids, and frame with brush. Drain. Flush out.
4. Remove drain-off faucet and fittings and disassemble drain line. Scrub draw off faucet and fittings with a flexible-handled brush. Pull back and forth through tube under running hot water. Thoroughly clean in detergent water. Carefully rinse with 180°F water to sanitize. Drain valves and tubing should also be cleaned and sanitized in a similar way.
5. Scrub exterior and frame. Use hot detergent water and brush.
6. Resterilize interior. Before using kettle, you should carefully rinse with 180°F water.

NOTE: The previous procedures are recommended for stainless steel kettles. If metals are aluminum, brightening or whitening is required. Boil with vinegar water for a short time period or use a product recommended for cleaning aluminum following the manufacturer's directions. Do not use caustic cleaners or steel

pads. If kettles are stainless steel, clean as directed earlier.

SAFETY NOTE: Make sure the safety valve is in proper working order before using a kettle

ELECTRIC GRIDDLE

The griddle (fig. 4-2) consists of cooking surfaces of various sizes up to 34 inches deep by 72 inches wide. Each has a readily removable grease receptacle in the front of the griddle and a splash guard at least 3 inches high at the rear of the griddle which is tapered at the sides. All thermostat dial knobs are conveniently located on the front panel. Each thermostat dial knob has a signal light that indicates the griddle is turned on until the griddle has reached the dialed temperature.

Operation

To operate an electric griddle, proceed as follows:

1. Carefully read the operating instructions posted near the griddle.
2. Preheat the griddle by turning the thermostat dial knob to the recommended preheating temperature according to the manufacturer's technical manual.
3. Set the thermostat dial knobs at the desired temperature listed on the recipe card of the food to be grilled. A red light will turn on automatically when the griddle dial is initially set and will turn off when the the griddle has reached the dialed temperature. The signal



Figure 4-2.-Electric griddle.

48.10

will flash on and off during the cooking process to show the correct temperature is being maintained. You are now ready to load the griddle.

4. Turn the griddle off or to the lowest temperature setting during idle periods.

Care and Cleaning

Keep the cooking surface scraped and wiped clean at all times. The grease gutters should always be kept clean to help in draining off excess grease and thereby reduce smoke. The grease receptacle should be emptied frequently and thoroughly cleaned at the end of the workday. Before starting the griddle cleaning procedure, always make sure the electrical power is turned off at the main power panel and the correct tag-out procedures have been followed. The cooking surface of most griddles can be satisfactorily cleaned with a pumice stone. Never use water. However, before cleaning, you should read the manufacturer's recommended cleaning instructions for that particular griddle surface. After each thorough cleaning, the griddle should be seasoned. Seasoning is done by preheating the griddle to 400°F. When the signal light goes off, spread a light film of cooking oil or fat over the entire surface of the griddle. In 2 minutes, wipe the surface clean of excess oil. Repeat this operation. The griddle is now ready for use.

TILTING SKILLET

Tilting skillets are large frying pans with deep sides and an attached lid. They are used to grill, fry, simmer, and braise large quantities of food. They can be mounted on a wall or on a stand and can be tilted at least 90 degrees from the normal horizontal position for emptying cooked foods and cleaning. Skillets are either gas or electric, have an electric thermostat, and have a temperature range of 100°F to 450°F. There is also a secondary thermostat that is a high-limit cutoff that disables the power circuit when the temperature exceeds 460°F. Gas skillets are also furnished with a pressure regulator, connector, quick-disconnect, and a 100-percent shutoff device for the pilot (automatic ignition of gas). Most skillets will also have a faucet directly attached to the skillet to aid in cooking and cleaning.

Operation

The skillet is heated from the bottom by either resistant heating elements or a series of gas burners. Usually, the tilting mechanism can be locked in any position. On some models, the tilting feature may have a safety switch to be engaged if the skillet is HOT or ON. If the skillet is provided

with a faucet, it may be connected directly to a water supply.

- NOTES:**
- (1) Keep the tilting mechanism thoroughly lubricated for ease of operation.
 - (2) Always turn off the heating element before tilting.

Care in Cleaning

The tilting skillet should be cleaned after each use. Before cleaning you must turn off the heating element and scrape off the hardened food from the inside of the skillet with a spatula or scraper and flush down the sediment with a small amount of water. If the skillet has become very dirty, fill it to the level with hot water containing a mild hand-dishwashing detergent. Turn on the heating element and allow the water to come to a boil. Boil the water for at least 5 to 10 minutes. Turn off the heating element, drain, rinse with warm vinegar water, then rinse thoroughly with clear water, and dry the skillet well. Clean the outside of the skillet with a grease-cutting detergent. Do not leave heating element turned on when the skillet is empty.

DEEP-FAT FRYER

Sizes of deep-fat fryers (fig. 4-3) are expressed in the number of pounds of french fries that can be cooked in an hour and range from 30 to 125 pounds. Some



48.11

Figure 4-3.—Deep-fat fryer.

deep-fat fryers are manually loaded. Others have automatic basket lowering and raising capabilities controlled by a timer.

Operation

Before filling the deepfat fryer, you should always check three things:

1. Master switch must be in the OFF position.
2. Thermostatic switch must be in the OFF position.
3. Drain valve must be closed tightly.

Fill the fryer with fat using the amount specified in the technical manual furnished with the fryer. Fats should be kept at least 2 inches below the fryer top. If possible, the fat should be heated and melted before placing it in the fry kettle. Cold solid fat may have moisture pockets that will explode, casting hot melted fat over a wide area. The temperature should not be more than 200°F while the fat is melting. Also, if the cold fat is not uniformly distributed around the heating element, the bare portions may heat up to a point where a sudden splash of fat on the overheated element will cause the fat to ignite. Fat ignites at 475°F. The fat should cover the uppermost coil at all times when the deep-fat fryer is in operation so as not to overheat the element and cause a fire. After the fat has been added, operate the deep-fat fryer as follows:

1. Turn on the master switch located outside the galley.
2. Set the thermostat at the cooking temperature prescribed in the *Armed Forces Recipe Service* (AFRS), NAVSUP P-7, for the recipe you are using.
3. Check the temperature of the fat with a hand thermometer frequently during the cooking process. Compare this hand reading with the thermostat reading to determine if the thermostat is accurate. The temperature should never, under any circumstances, go above 400°F. A safety requirement on all Navy fryers includes a second or over-temperature thermostat. This is a nonadjustable, manual, resetting type installed to limit the maximum temperature to 460°F. In case of failure of the adjustable automatic thermostat, the over-temperature thermostat disconnects the electric power to the heater elements.
4. Have foods as free from moisture as possible before frying. Excess moisture causes the fat to foam, sputter, and boil over. It also causes fat to break down and its useful life is shortened.

5. Do not fry bacon in the deep-fat fryer, as the fat from the bacon causes the fat level to rise above the safe level. It also contains salt that will shorten the life of the fat.

6. Follow instructions furnished with the fryer. Do not exceed the capacity of the fryer indicated on the instruction plate.

7. Never let the fat level fall below the point marked in the fat container, and never leave the deep-fat fryer unattended while in use.

8. In the event a fire should occur in the deep-fat fryer, do not attempt to smother the fire with a cover of any sort. Call the emergency number for reporting a fire at your command and shut off the electrical source, which is the main power switch outside the space, to the fryer. If the fryer is provided with an automatic fire extinguishing unit and does not set off automatically, pull the manual release. If that does not function, use PKP portable extinguishers.

NOTE: Under any circumstances, do not use water to extinguish the fire.

Cleaning

The deep-fat fryer should be cleaned after each use. Before cleaning the deep-fat fryer, you must turn off the heating element and allow the fat to cool to about 150°F. Drain the fat out of the fryer. Then remove the basket support screen, scrape off the oxidized fat from the sides of the kettle with a spatula or scraper, and flush down the sediment with a small amount of fat. If the kettle has become very dirty, fill it to the level with hot water containing dishwashing machine detergent. Turn on the heating element and allow the water to come to a boil. Boil the water for at least 5 to 10 minutes. Turn off the heating element, drain, rinse with warm vinegar water, then rinse thoroughly with clear water, and dry the fryer well. Clean the outside of the fry kettle with a grease solvent. Do not leave heating element turned on when the deep-fat fryer is empty.

ELECTRIC OVEN

Electric ovens have two to six compartments with two heating units in each compartment, one located below the bottom deck of the compartment. Each heating unit is controlled by a separate three-heat switch, and the temperature of each section is regulated by a thermostat.

Operating Instructions

The oven should be preheated before it is used by turning both upper and lower units to high until the desired temperature is reached. Then, the thermostat control will automatically cut off the current and will supply only enough heat to keep the temperature constant. After the oven has been heated, set the two three-heat oven switches at the top and bottom to the heat setting necessary to bake the product. In roasting meat, avoid spilling grease on the heating elements or thermostat, as damage to this equipment may result.

Care and Cleaning

Turn off heat. Scrape interior. Sprinkle salt on hardened spillage on oven floor. Turn thermostat to 500°F. When spillage has carbonized completely, turn off oven and let it cool thoroughly. Scrape the floor with a long-handled metal scraper. Use a metal sponge or hand scraper on inside of doors, including handles and edges. Brush out scraped carbon and loose foods. Begin with the top deck if stacked. Brush out

with a stiff-bristled brush and use a dustpan to collect. Wash doors with hot detergent solution on enameled surfaces only, rinse, and wipe dry. Brush combustion chamber using a small broom, and brush to clean everyday. Wash top, back, hinges, and feet with warm hand-detergent solution, rinse, and wipe dry. Clean and polish stainless steel exterior.

CONVECTION OVEN

A convection oven (fig. 4-4) has a blower fan that circulates hot air throughout the oven, eliminating cold spots and promoting rapid cooking. Overall, cooking temperatures in convection ovens are lower and cooking time is shorter than in conventional ovens. The size, thickness, type of food, and the amount loaded into the oven at one time will influence the cooking time.

General Operation of Convection Ovens

The general operating procedures for convection ovens are as follows:



Figure 4-4.-Convection oven.

48.131

1. Select and make the proper rack arrangement for the product to be cooked.

2. Turn or push the main power switch on (gas oven—turn burner valve on). Set the thermostat to the recommended temperature. The thermostat signal light will light when the power goes on. If possible, adjust the fan speed on the two-speed blower.

3. Preheat oven until the thermostat signal light goes out indicating that the oven has reached the desired temperature. The oven should preheat to 350°F within 10 to 15 minutes. (**NOTE:** To conserve energy, do not turn on the oven until absolutely necessary—approximately 15 minutes before actual cooking is to start.)

4. Open the oven doors and load the oven quickly to prevent excessive loss of heat. Load the oven from the top, centering the pans on the rack toward the front of the oven. Place partial loads in the center of the oven. Allow 1 to 2 inches of space between the pans and along the oven sides to permit good air circulation. Remember—overloading is the major cause of nonuniform baking and roasting.

5. Close the oven doors and set the timer for the desired cooking time. Check periodically until the product is ready for removal.

TEMPERATURE SETTINGS.— Follow the recommended temperature guidelines provided either in the manufacturer's operating manual or those furnished in the AFRS, NAVSUP P-7, or reduce the temperatures specified on the recipe cards by 50°F. If food is cooked around the edges, but the center is still raw or not thoroughly cooked, or if there is too much color variation (some is normal), reduce the heat by 15°F to 25°F and return food to the oven. If necessary, continue to reduce the heat on successive loads until the desired results are achieved. Record the most successful temperature on the recipe card for future reference.

TIME SETTINGS.— Follow the recommended times provided in the manufacturer's operating manual, or follow the guidelines in the AFRS. Check progress halfway through the cooking cycle since time will vary with the quality of food loaded, the temperature, and the type of pan used. Remember, the use of meat thermometers for roasting and the visual examination of baked products are the most accurate methods of determining the desired cooking times, both in convection and conventional ovens.

VENT DAMPER CONTROL SETTING.— The vent damper control is located on or near the control

panel. The damper should be kept closed for most foods of low moisture content such as roasts. Leaving the vent open during roasting will produce a dry meat and result in excessive shrinkage.

The damper should be kept open when baking items with high moisture content (cakes, muffins, yeast bread, and so forth). Leaving the damper closed throughout a baking cycle will produce cakes that are too moist and ones that will not rise. A "cloud" of water droplets on the oven window indicates excessive moisture that should be vented out of the oven through the open damper.

INTERIOR OVEN LIGHTS.— Turn on lights only when loading, unloading, or checking the product. The continual burning of lights will result in a shortened bulb life.

TIMER.— The oven timer will ring only as a reminder; it has no control over the functioning of the oven. To assure proper operation, you should wind the timer to the maximum setting, then turn it back to the setting desired for the particular product.

Care and Cleaning

Keep the inside of the oven and racks clean. If food particles or carbon accumulates so that doors cannot be tightly closed, heat is wasted and the oven will not operate properly. Poorly closed doors permit a constant escape of steam and vapor around the door. The vapor will condense and deteriorate the finish around the oven front and door lining.

The rule for all electrical appliances is to make sure the proper tag-out procedures have been followed.

When cleaning the interior of the oven, it is important to bear in mind that the aluminum coating, though tightly adherent, is still a coating. To preserve the coating and to make maintenance easier, clean the interior daily when the oven is cold with a mild detergent or soap and water. This will prevent food and dirt from "baking on" and will frequently be all the cleaning that is necessary.

If soil resists soap and water cleaning, use a wooden tool to loosen spillage from the cold oven. Follow with a nonetching cleaner that is specifically recommended for aluminized steel. Use clear water to rinse; dry with a soft clean cloth. Avoid using wire brushes and caustic solutions such as lye, soda ash, or ammonia.

- When the oven liner features stainless steel the following rules apply:

In general, the principles detailed previously apply. Soap or detergent and water will usually take care of routine cleaning. Drying should be done with a soft clean cloth.

For burnt-on foods and grease that resist simple soap and water cleaning, an abrasive cleaner mixed into a paste may be used. Apply with a sponge, always rubbing with the grain. This treatment is usually effective for heat tint (slightly darkened areas caused by oxidation). Again, remember to rub in the direction of the polish lines. Rinse with clear water and dry with a soft cloth.

- When Teflon panels are featured, the following rules apply:

To protect the easy-care properties of Teflon-coated oven panels, frequent cleaning, dependent on oven usage, is recommended. Panels should be cleaned as soon as soil begins to turn brown. This will minimize the possibility of Teflon discoloration. Do not use sharp instruments, abrasive materials, or oven cleaners on a Teflon surface, otherwise the warranty is void. Should the surface be accidentally scratched, the performance and cleanability features would be adversely affected.

To clean the Teflon panels, remove panels and wash thoroughly with hot sudsy water using a sponge or web pad that is supplied with the oven. Do not use harsh abrasives. Rinse well and dry. Between these cleanings, everyday oven spatters can be easily sponged off with a sudsy sponge or a cloth, rinsed, and dried. With Teflon, there is never a need for oven cleaner. The step-by-step sequence for removing panels is as follows:

1. Remove tray racks by pulling straight out.
2. Remove right and left rack guides by lifting straight out.
3. Right- and left-hand panels may now be removed by moving toward the center and pulling out. To avoid scratching, do not rest panels on bottom panel.
4. Remove bottom panel by pulling straight out.
5. Remove blower baffle by lifting straight up and pulling out toward the front. Care should be exercised to clear brackets on the side.
6. Blower wheel can now be cleaned in place.
7. Top panel and interior door panels can be cleaned while in place.

8. If removal of top panel is desired, unscrew three screws from the front top edge of top and two screws from rear flange of top.

9. Slide out toward front.

To reassemble, reverse these procedures.

To keep the stainless steel front bright and gleaming at all times, just clean it regularly with a damp cloth and polish with a soft dry cloth. To remove discolorations that may have formed when regular cleaning was neglected, use any detergent or plain soap and water.

Wash all exterior surfaces daily. Use a cloth wet with warm water and a mild soap or detergent. Where surfaces have been polished, rub lightly with a cloth-hard rubbing will remove polish. Follow with a clean damp cloth, then dry. This simple beauty treatment not only keeps your equipment dirt-free and sparkling, but virtually eliminates the danger of grease accumulation that may form a stubborn stain if left on too long. (**NOTE:** Do not sprinkle or pour water over oven as it may cause an electrical short.)

General Notes

Most convection ovens are equipped with an electric interlock that energizes/de-energizes both the heating elements and the fan motor when the doors are closed/open. Therefore, the heating elements and fan will not operate independently and will only operate with the doors closed. Some convection ovens are equipped with single-speed fan motors while others are equipped with two-speed fan motors. This information is particularly important to note when baking cakes, muffins, meringue or custard pies, or similar products, and when oven-frying bacon. High-speed air circulation may cause damage to the food (for example, cakes slope to one side of the pan) or blow melted fat throughout the oven. Read the manufacturers' manuals and determine exactly what features you have and then, for the previous products, proceed as follows:

- On two-speed interlocked fan motor: set fan speed to low.

- On single-speed interlocked fan motor: preheat oven 50°F higher than the recommended cooking temperature. Load oven quickly, close doors, and reduce thermostat to recommended cooking temperature. (This action will allow the product to be baked to setup before the fan/heating elements come on again.)

- On single-speed independent fan motor: preheat oven 25°F above temperature specified in recipe. Turn the fan off. Reduce heat 25°F. Load oven quickly and close doors. Turn fan on after 7 to 10 minutes and keep it on for remaining cooking time. **(EXCEPTION:** Leave fan off for bacon to eliminate fat from blowing throughout the oven.)

Read and understand the manufacturers' manuals. They will make your job easier and safer.

ELECTRIC RANGES

Electric ranges are normally found in private messes, small ships, and submarines. Range descriptions and uses will now be explained.

Types S

Type S (fig. 4-5) is found on submarines. The type S is a compact galley unit consisting of a griddle on the left side and hot plates on the right side. A

NOMENCLATURE

- 1 SPLASH GUARD FOR GRIDDLE
- 2 GRIDDLE
- 3 GREASE RECEPTACLE, GRIDDLE
- 4 DRIP PANS, GRIDDLE, HOTPLATE
- 5 THERMOSTATIC CONTROL DIAL, LEFT SIDE, GRIDDLE
- 6 THERMOSTATIC CONTROL DIAL, RIGHT SIDE, GRIDDLE
- 7 THERMOSTATIC CONTROL, LARGE HOTPLATE
- 8 SMALL HOTPLATE, FRONT
- 9 SMALL HOTPLATE, REAR
- 10 LARGE HOTPLATE
- 11 TOP OVEN
- 12 BOTTOM OVEN
- 13 THERMOSTAT DIAL CONTROL FOR TOP OVEN
- 14 THERMOSTAT DIAL CONTROL FOR BOTTOM OVEN
- 15 OVEN VENT
- 16 DAMPER CONTROL, TOP OVEN VENT
- 17 DAMPER CONTROL, BOTTOM OVEN VENT
- 18 OVEN DOOR RELEASE
- 19 SEA RAIL SUPPORT
- 20 SEA RAIL

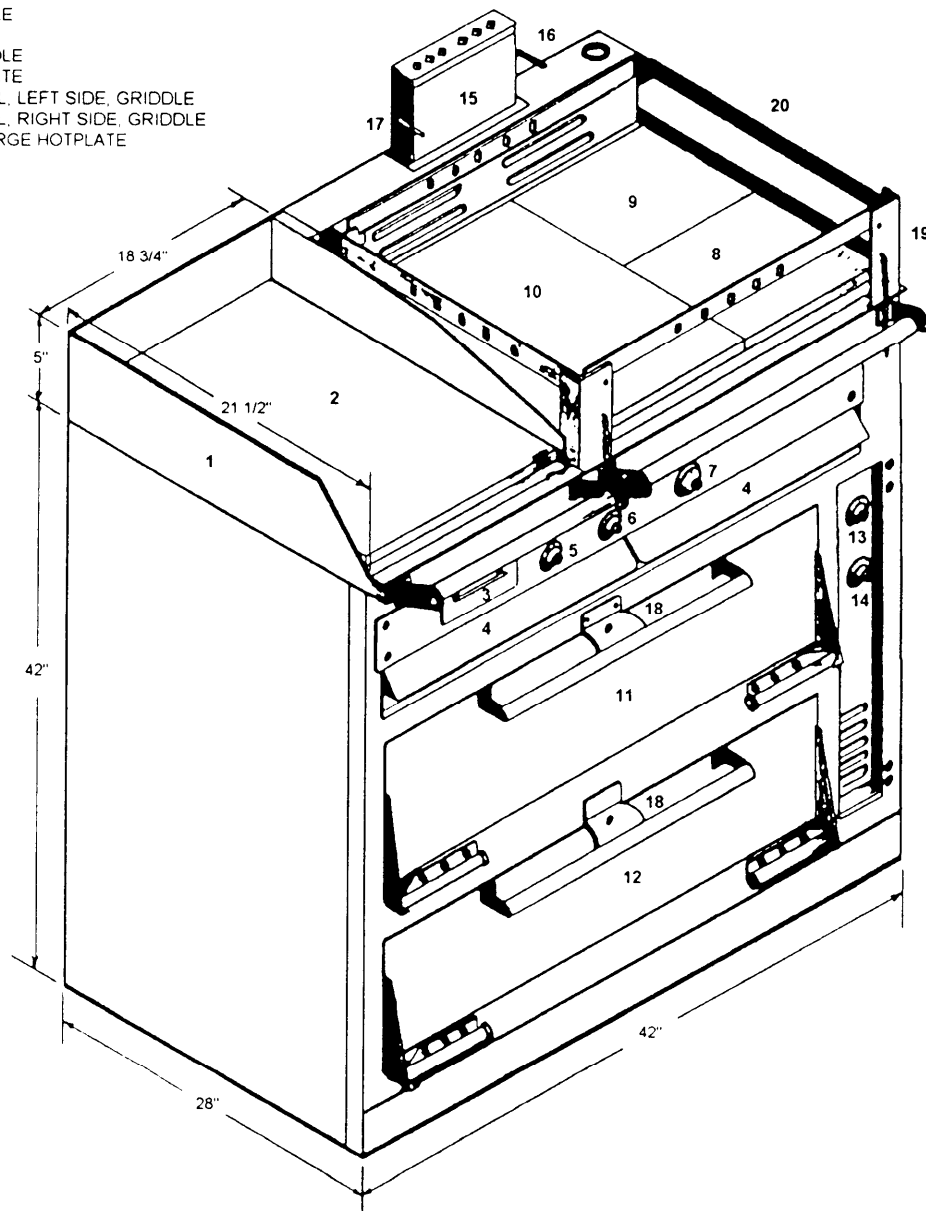

Figure 4-5.—Type S electric range.

two-compartment oven section makes up the body of the range. Dial temperature control knobs are mounted on the body directly adjacent to each section. The temperature control knobs for the ovens are located directly to the right of each oven compartment.

Type C

Type C (fig. 4-6) is found on small ships and private messes where small galleys with limited space are found. This type of range consists of a griddle on the left side and hot plates on the right side with a single oven located in the body of the range. This type of range is also available with a single griddle top and single oven compartment. Dial temperature control knobs are mounted on the body directly adjacent to each section. Control knobs for the oven compartment are located to the right of the oven compartment.

Operation of Surface Units

When operating the surface unit, use the control knob or thermostat setting at maximum heat only to heat food to cooking temperature or to bring water to a boil, then reduce the control knob setting to the heat required by the food being cooked. Using more heat than necessary is not only a waste of power but produces inferior food. Do not leave the surface unit turned on when not in use. When steaming food, keep cooking utensils covered. The food will stick and burn if left uncovered and power will be wasted.

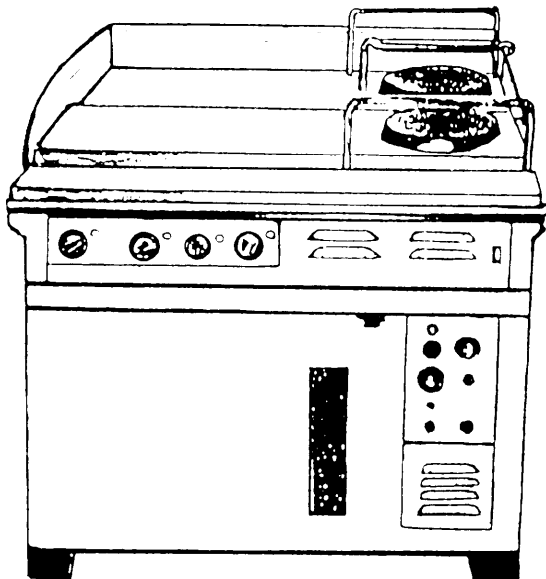

Figure 4-6.—Type C electric range.

Care and Cleaning

Keep the range surface units clean and avoid spilling grease under the edges of the hot plates. Remove and clean drip pans after each use.

To clean the surface units follow the cleaning procedures used for griddles and the manufacturer's technical manual for your range.

To clean the oven compartment use the procedures recommended by the manufacturer's technical manual or the cleaning procedures posted near the range.

ELECTRIC FOOD MIXER

Electric food mixers are used for an infinite number of jobs including beating batters for cakes, mixing bread dough, beating eggs, and mashing and whipping potatoes.

Sizes and Attachments

Food-mixing machines (fig. 4-7) are furnished in 20-, 60-, 80-, 110-, and 140-quart sizes with the necessary attachments, paddles, and beaters (fig. 4-8). The wire whip is used for eggs, cream, and lightweight mixing; the flat beater for cake batters and

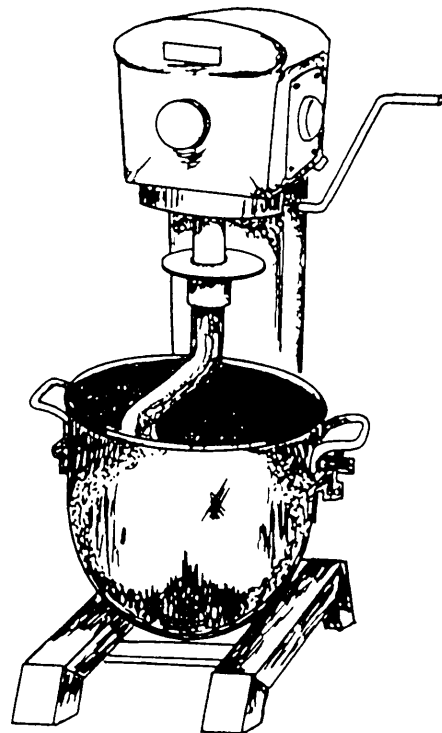

Figure 4-7.—Electric mixer.

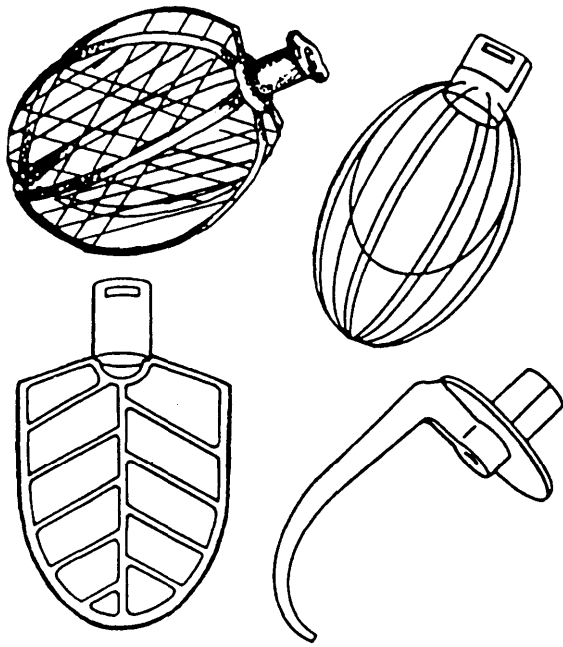

Figure 4-8.—Electric mixer attachments.

mediumweight mixing; the dough hook for mixing bread dough; and the wire beater for medium-stiff dough.

One part of the machine revolves through the use of a set of transmissions and differential gears. Various shaped paddles and mixers can be attached to this revolving unit.

The lower part of the mixer contains two extended, adjustable arms. A bowl, containing the foods to be mixed, is placed on these arms and the arms are then moved up so the paddles will revolve throughout the mixture. The machines have either three or four speeds. Usually they have an attachment hub that can be used for a vegetable slicer, juicer, and meat grinder.

Operation

Before operating the machine make sure the bowl, paddles, and beaters are thoroughly clean. If necessary, wash them in hot soapy water and rinse with hot water (170°F).

Place the ingredients in the bowl as specified on the AFRS recipe card. Do not fill the bowl more than half full. Place the bowl on a castored dolly when moving across the deck. Insert the bowl in the mixing machine, making sure the bowl ears are on the supporting pins and both sides are locked in place.

Select the proper attachment and place it in the machine. The L-shaped notch in the beater is to be

inserted over the pin in the shaft. On the smaller models the shaft will be grooved. The attachment is inserted into these grooves and slipped into the lock. Raise the bowl to the proper height by turning the wheel or crank.

Start the motor at no load and with clutch release shift to low speed; release the clutch each time the speed is changed. The speed to be used is indicated on the recipe card and on the instructions furnished by the manufacturer.

Watch mixing times and mixing speeds carefully. Often blended ingredients revert to separate ingredients if mixed too long or at an improper speed. If, during the process of mixing, some of the batter has piled up on the sides of the bowl, stop the machine. Using a long-handled spoon or spatula, scrape down the sides of the bowl. Never put spoons, spatulas, or your hands in the bowl while the machine is in operation.

When the mixing is completed, move the control switch to the OFF position and stop the motor. Lower the bowl by the lever with which you raised it and remove the beater by turning the sleeve to the left. Remove any food left on the beater with a spatula. Then, place the bowl on the castored dolly and move it to the place of use.

Care and Cleaning

The electric mixer, beaters, whips, and bowls all require care. Beaters, paddles, and bowls should be washed immediately after each use. Use hot soapy water and rinse with hot water (170°F). Hang beaters and paddles upside down to air dry. Clean the body of the machine after each meal. Use a damp cloth or wash with water as necessary for proper sanitation. Be sure the beater shaft is free of all dirt and food particles.

The motor and mechanical parts of the mixer should be inspected and maintained by the engineering department once a week.

ELECTRIC MEAT-SLICING MACHINE

The meat-slicing machine (fig. 4-9) is motor operated and is used for slicing hard or soft foods such as roasts, cheese, bacon, luncheon meats, and ham.

The machine has a carriage on which the meat is placed. A swiftly revolving disk knife slices the meat as the carriage is moved across the face of the revolving knife.

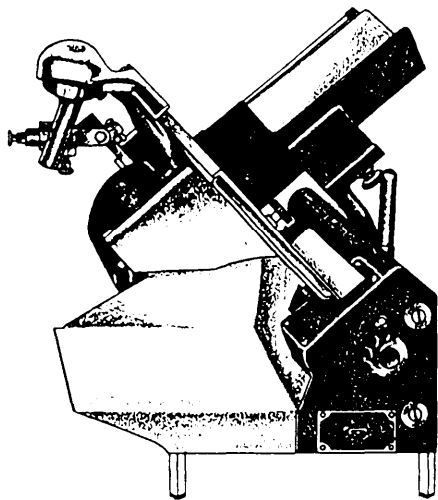

Figure 4-9.—Electric meat-slicing machine.

Operating the Meat Slicer

Meat slicers may be either manual or automatic feed. To use the slicer, place the meat on the carriage and adjust the clamp to hold the meat firmly. Next, set the dial for the desired thickness of the slices. Set the machine on automatic or manual. Turn on power to the machine. If manual mode was selected, move carriage back and forth with the hand lever.

The meat-slicing machine must be hardwired (permanently attached) and have a backup electric switch. The switch will be equipped with a guard to prevent accidental starting. The meat slicer is a very dangerous piece of equipment. Never operate it with the blade guard off or put your hands anywhere near the blade while the blade is turning. The blade is very sharp, so extreme caution should be used when sharpening or cleaning it.

Care and Cleaning

The meat-slicing machine must be cleaned after each use. Before dismantling the slicer, you must make sure the electric power is secured. Remove all cutting and meat-handling attachments. Wash the attachments with soap and hot water; rinse with hot water. The attachments may be run through the dishwashing machine. Clean the knife and the body of the slicer by following the manufacturer's recommended cleaning instructions or the instructions posted by the machine. Reassemble the slicer immediately so that the bare blade will not be exposed and apply a thin coating of salad oil on the blade. Do not forget to clean the counter top under the slicer.

STEAMERS

Steamers are used for steaming fish, fruit, meat, poultry, and vegetables. Most steamers used in the Navy consist of a three door, three-compartment unit. Each unit has one or two perforated pans or baskets.

Operation

When operating steamers, you are not limited to the use of pans and baskets furnished with them. If juices are to be saved, you should cook in leakproof solid pans of a suitable size. Pans should not be overloaded; steam circulates best when pans are about three-fourths full. Different foods may be cooked in the same steam compartment without mixing flavors or affecting the taste of the different foods. Onions and pudding placed in individual pans may be cooked in the same steam compartment without a transfer of flavor.

After the food has been placed in the steamer, close the compartment door securely. (The door latch is linked with the steam supply on most steamers, and the final movement of the lever locks the door and turns on the steam at the same time. Unlocking the door turns off the steam before the door can be opened.)

If the steam supply is controlled separately, open the steam valve slowly by turning the valve wheel counterclockwise after the door is latched. Then observe the middle indicator on the pressure gauge, which should be in the range of 5 to 7 psi. Turn the valve wheel clockwise to reduce steam pressure if it is above 7 psi. Watch your cooking time closely and avoid spoiling food by overcooking. Less time is required for steam pressure cooking than for boiling food in water; the temperature of steam at 7 psi is 233°F and the boiling temperature of water is 212°F.

After cooking has been completed, turn off the steam supply by turning the valve wheel clockwise on separately controlled units, or by unlatching the compartment door of the latch-controlled steam supply. You can relieve the steam pressure by operating the lever of the safety valve, if one is provided; otherwise, wait 2 minutes before you open the door to the full OPEN position. The gauge should read 0 psi before the door is opened.

Care and Cleaning

Occasionally, when you examine the drainpipe for steam-condensate drip, none will appear after a few minutes of steamer operation. When this is the case, turn off the steam supply by unlatching the door or

closing the valve, as necessary. The fault normally is stoppage in the trap, strainer, or drainpipe. To eliminate this condition, close the steam valve, remove the steam-trap strainer basket, and clean it by scraping out the solids and washing the basket until the mesh or perforations are open and clear. Clean the pipe connection in the steamer compartment, reassemble the strainer, and repeat the pressure cooking. If there is still no drip, the steam trap is at fault, so report this to the engineer officer via the chain of command.

After each meal, the steamer should be brush-scrubbed, washed clean with hot soapy water, and rinsed with hot water (170°F) and allowed to air dry.

HIGH-COMPRESSION STEAMER

The high-compression steamer (fig. 4-10) is a modular unit that is used to defrost and cook food by using high-velocity steam. When steam enters the unit, it is piped to a jet box from which it is jetted directly onto the frozen food at approximately 200 miles per hour (mph). The steam gains the high velocity by being forced through a series of small perforations.



48.132

Figure 4-10.—High-compression steamer

Operation

Check the steam supply gauge; 15 psi is needed for proper operation. Insert foods into the cooking chamber; then place the frozen food directly under the jet box; close and seal the door. Select the time (from 5 to 60 minutes) for the food to be cooked. Turn the selector switch to 60 minutes and then back to the desired cooking time. The pilot light indicates that cooking is in progress. Food is defrosted and cooked auto-matically. The pressure gauge rises to approxi-mately 5 psi and increases to 15 psi after 2 minutes, where it will stay until cooking has been completed. The door must be kept locked until the cooking cycle has been completed. All steam will exhaust automatically and the buzzer will sound when the cooking cycle has been completed.

Care and Cleaning

The steamer should be cleaned at the end of each day that it has been used. To clean the jet steamer, remove the jet plate, pan supports, and door, including the gasket around the door, and wash in warm soapy water. Rinse well in warm water. Scrub the interior of the cylinder with warm soapy water and rinse well.

The door gasket must be kept clean at all times. With normal closing and locking of the door assembly, a steamtight seal should be made between the door gasket and the door opening. This seal cannot be maintained if particles of foreign matter are allowed to accumulate upon either of the contacting surfaces.

If leakage of steam occurs, the door assembly is improperly adjusted and a readjustment must be made to the adjustment screw.

VENTILATOR HOODS

Ventilator hoods, like people, come in a variety of shapes, sizes, and appearances, and vary in their effectiveness from barely acceptable to highly efficient. The filter-type hoods fall into the barely acceptable category, and the filterless grease extractors—mostly known as Gaylord ventilators—are the most efficient. Filter-type hoods are the hardest to keep clean and are gradually being re-placed as funds allow. They generally have no built-in fire protection system. If the filters are not replaced after cleaning, a buildup of grease deposits in the exhaust duct system could lead to a fire! Depending upon the type of fumes exhausted and the amount of use, the filter should be removed and washed in the dishwasher or deep sink daily, or no less than once

a week. The hood chamber behind the filters should be cleaned while the filters are out and you should be sure the filters are then put back. Also, remember, with all ventilators, to remove the access cover plates on the exhaust ducts, inspect for grease buildup in the ducts, and clean as necessary.

The hood, generally referred to as the Gaylord (named after the original manufacturer), is the type that uses an arrangement of internal baffles to cause the exhaust air to quickly change direction several times before it enters the exhaust duct. In so doing, the air slings the grease out into the grease trough that is built into the bottom part of the hood. This action is what gives the hood the name of centrifugal grease extractor. Other than the air, the only moving part in this system is the fire damper that is spring-loaded to close the throat or inlet air slot in case of fire, and this damper, when open, also serves as the first of the air baffles. All the action up to this point is carried out automatically by the hood as long as the exhaust blower is operating correctly.

Another automatic feature is the fire-sensing thermostat located in the exhaust ductwork close to the hood. From the outside, this looks like an aluminum box about 2 1/2 inches wide by 4 inches long by 1 1/2 inches deep. On the back of this, and projecting inside the duct, is a thermostat probe that is constantly checking air temperature in the exhaust duct. If a fire starts, and the air going by the thermostat reaches 250°F, the thermostat switch operates a magnetic trip inside the fire damper control box (the one with the plunger mounted above the hood), the fire damper slams shut, and the blower shuts down. In later model hoods with automatic cleaning (more about this later), this condition also will cause the automatic water washdown system to come on and spray water into the hood until the temperature at the thermostat is less than 250°F. On earlier models, the water or steam must be turned on manually. All shipboard model grease extractor hoods are fail-safe in that power failure or thermostat failure will cause the fire damper to close. This information will also be found on the nameplate on the damper control box. Complete technical information on airflow, electrical characteristics, and other data of primary use to engineering personnel can be found in the *NAVSEA Technical Manual*, 0938-027-5010.

So much for the automatic features that the hood will perform. Now, on to the part that you, as an MS, should do to keep it working and ventilating properly.

All centrifugal grease extractor hoods require at least daily cleaning. You may find three different types

of cleaning systems, all having a look-alike appearance but slightly different in method:

- Steam cleaning (manual)
- Hot water cleaning (manual)
- Detergent washdown system (automatic and manual)

In both steam cleaning and hot water cleaning, you must shut off the exhaust blower motor at the control panel, turn on the steam or hot water valve in the line leading to the upper part of the hood and allow it to run for 5 minutes or more, depending on how dirty the inside of the hood gets. If hot water is used, the temperature should be between 130°F and 180°F, and the closer to 180°F the better. After shutting off the steam or water, open the inspection doors on the ventilator and see if the grease and dirt have been flushed away. If the entire hood interior is still dirty, you need to leave the valve open longer. If only a certain area is dirty, you may have a clogged spray nozzle. Clean the hole in the nozzle with a small piece of wire.

During the washdown, watch the drain line from the bottom of the hood. It should run freely and should be dumping through an air gap to a deck drain. No shutoff valves are allowed in the drain line and the line should never be directly connected to a drain. Otherwise, a stopped-up drain could allow sewage to backup into the hood and spill into food and food equipment. Hand-clean all exposed surfaces of the hood including the front surface of the fire damper baffle. Watch your fingers when cleaning the damper. If the damper is accidentally tripped, it could pinch your fingers against the back of the hood.

Automatic cleaning is a timed, push-button cleaning system. A dishwasher scrubbing action with detergent and hot water is obtained by directed spray nozzle action. The nozzles are located on 8- to 10-inch centers on the cleaning pipes mounted on the interior back wall of the ventilator. The cleaning cycle is activated each time the blower serving the ventilator is stopped by pushing the STOP button on the exhaust control and cleaning station. This shuts off the blower and releases detergent and hot water into the ventilator for a preselected and preset time on the adjustable timer in the exhaust control and cleaning station.

After the cleaning cycle has been completed, follow the same steps as previously explained in manual cleaning, except clean the detergent tank and refill, if needed, with the correct detergent. Note that the timer for the automatic wash cycle is located in the stainless

steel cabinet that houses the exhaust control and cleaning station. The length of the automatic wash cycle is adjustable and should be adjusted for the minimum time that will satisfactorily clean the hood. This will conserve utilities and detergent.

The hot water shutoff valve, usually located in the cleaning station cabinet, should always be left on unless plumbing repairs are necessary. On some ships, where low water pressure or the amount of hot water available is a problem and where all galley hoods are connected to a single automatic wash system, installing activities have found it necessary to install individual shutoff valves in the hot water/detergent line at each ventilator hood. In these cases, be sure only the valve at the hood to be cleaned is turned on. If you have an arrangement like this, for fire protection purposes, leave the valve to the hood serving deep-fat fryers turned on and all others off, except when they are actually being washed. Directions for priming the detergent pump are located most often on the inside of the door. Motor bearings on the detergent pump should be oiled once every 6 months.

DOUGH TROUGH

A dough trough is the container in which dough is placed during the fermentation period. It is an oblong boxlike trough of steel construction equipped with four casters to permit easy movement in the bakeshop area.

Dough troughs are of various lengths and are designed to hold approximately 90 pounds of dough to a foot, or 50 pounds of flour to a foot. If the trough is too long for the amount of dough to be fermented properly, dam boards maybe inserted so that the correct amount of space is available.

DOUGH PROOFERS

Dough proofers or fermentation rooms are used for conditioning dough and cooling baked bread. The air temperature and air moisture (humidity) in a dough proofer are kept at preset levels by automatic controls. Dough proofers are thermally insulated enclosures and vary in size from a small box with shelving to a room with space for many portable bread racks. The dough proofer is heated by steam coils or electric heating elements located inside the enclosure, or by self-contained air-conditioning units connected to the proofer by air ducts. For shipboard use, steam-heated dough proofers are furnished in various sizes; the number and size of the proofers depend on the capacity of the bake ovens installed in the bakery on board ship.

Operation

The operation of all dough proofers is basically the same regardless of the size of the proofer. Air within a proofer should be kept at a preset temperature and moisture level. Dough proofers require at least 1 hour to attain the proper atmosphere; the unit should be started well in advance of anticipated use.

The time and temperature used to proof bread dough in the proofer should be as specified on the recipe card. Turn the steam valve on full and open the petcock to provide the necessary amount of steam for humidity. Adjust the steam inlet valve to obtain the desired temperature. When the temperature and humidity are correct, place the pans of dough into the proofer and close the door.

Watch the time closely and test the dough periodically by pressing the fingers into it. If the depression is filled by rising dough, fermentation is progressing properly. To reduce fermentation, cover the bread pans with cloths and reduce the proofer temperature. At no time should there be more than 35 pounds of steam pressure allowed to pass through the steam coils of the proofer. Drain the condensation from the drip pan at regular intervals by opening the petcock.

Care and Cleaning

Proofers should be maintained in a safe, sanitary, dust-free, rust-free, nonleaking, and economical operating condition. The enclosures and accessories should be kept free of flies, ants, cockroaches, mice, and rats.

Clean the floor, walls, top, and inside of the door. Scrape sides, corners, and guide rails with a putty knife. Scrub the floor with along-handled scrub brush and hot machine-detergent solution; rinse and dry. Wipe guide rails and ledges thoroughly. Remove and clean water pan; rinse and wipe dry. Scrub exterior and underneath if space permits; flush with hot water.

BREAD SLICER

The bread slicer is a machine with small thin blades. The platform on which the bread is placed is at about a 45-degree angle so that the weight of the bread will force the loaf down on the cutting blade when the machine is turned on. The cutting blades are attached to a cam shaft that has half the blades going in one direction and the other half going in the opposite direction. The reason for this is so that it will not tear the loaf while it is being

sliced. Never use your hand to push the load through the machine.

VEGETABLE PEELERS

Vegetable peelers (fig. 4-11, view A) have capacities of 10, 15, 30, or 50 pounds and have a cylindrical hopper with an abrasive-covered wall and an abrasive-covered rotary disk in the bottom. The disk has a wavy surface. This surface agitates the vegetables in such a manner that they continually present new surfaces for action by the abrasive material.

Operation

Before loading the machine, sort the vegetables so that those in any one load are of the same size and free of stones, sticks, and other hard objects. The machine should be started and the water turned into it before any vegetables are added. Do not overload the machine. The quantity of vegetables loaded should not exceed approximately 66 percent of the total hopper capacity. A larger quantity will not be thoroughly agitated.

If the abrasive surfaces of the machine are kept reasonably clean, a load of vegetables should be satisfactorily peeled in about 1 minute. Deep eyes or depressions in potatoes should be removed and



Figure 4-11.—Vegetable peeler (view A) and vegetable cutter (view B).

the peeling finished with a hand peeler or small knife. It is wasteful to allow vegetables to remain in the machine longer than necessary because valuable nutrients will be lost.

Cleaning

At the end of each day's use, secure the power and dismantle the machine. Lift the cover off and take out the abrasive disks; remove the peel trap and strainers; wash the removable parts, the interior, and the exterior of the machine with hot soapy water, and rinse with hot water (170°F). Be sure all food particles are washed out. Allow all parts to air dry before reassembling the unit.

ELECTRIC VEGETABLE CUTTERS

Vegetable cutters (fig. 4-11, view B) are machines that, without the use of attachments or removable parts, make three classes of cuts of vegetables—shredded, sliced, and grated. A dial control on the side of the machine allows instant changing of the thickness of the cut, even while the machine is in operation.

The entire front of the machine swings open to provide complete access to the interior for the purpose of cleaning and changing the blade. The machine should be washed with hot water immediately after it is used. The knurled knob holds the front of the machine securely when it is in operation.

Clean and scrub the knives and bowl with hot, soapy water and a very stiff brush. Rinse them well with hot water (170°F) and allow them to air dry thoroughly before reassembling.

VEGETABLE CUTTER AND SLICER

The vegetable cutter and slicer is used to cut vegetables that are to be used for cooking and for salads. The machine may be used to do as many as three different cutting jobs at once. It may be used for slicing either bias or horizontal french fries and julienne strips, and for coarse and fine chopping. The machine has a slicer adjustment for thicknesses up to one-fourth of an inch. The adjustment can be made while the machine is in motion. To make french fries or diced potatoes, the potatoes must be sized so that they will go into the machine.

When the machine is turned on, put a pan underneath the outlet to catch the water and vegetable particles and flush with water. This should be done after each use.

At the end of the day disassemble the machine and thoroughly clean the cutting plates and disks. Carefully inspect each part for strings of vegetables that may not have washed off.

This machine has parts that must be oiled daily to prolong the life and efficiency of the machine.

MEAT SAW

Electric sawing machines (fig. 4-12) are used mainly for cutting chilled, frozen, and smoked meats into steaks and chops. It is important to know that meat can be cut more uniformly by machine when there is still some frost in the boneless piece.

The saw is made to revolve by a mechanical arrangement of two wheels and an electric motor. The table on which the meat is laid is constructed so that you can cut the meat to any desired size. The saw blades themselves are five-eighths of an inch wide and about 10 feet long.

Operation

Before operating the saw, you must tighten the blade using only one hand to apply just enough tension to keep it from slipping. Feed the meat straight through giving

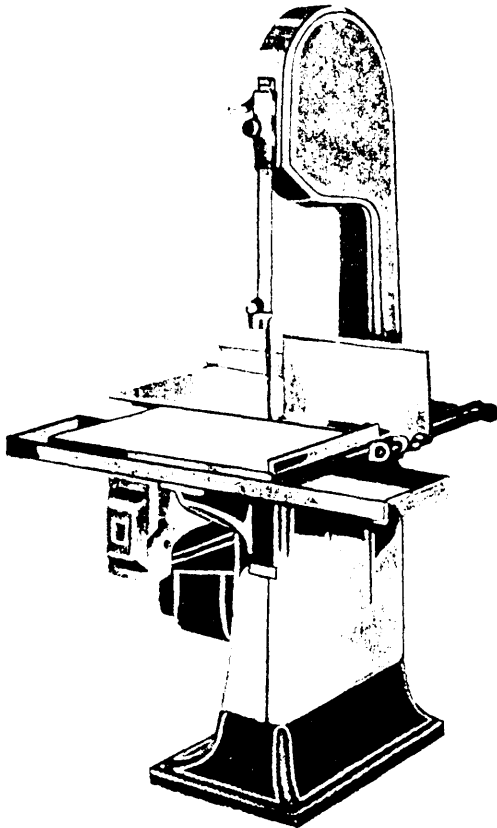

Figure 4-12.—Electric sawing machine.

the blade a chance to cut. Do not force. Use only sharp blades. Dull blades may heat up, twist, and break.

The electric meat cutter is a dangerous piece of equipment. A great deal of care is necessary to avoid injury when you operate this machine. There are seven safety precautions that should be observed when you are operating the meat saw:

- Always wear safety glasses or impact goggles when using the saw.
- Before you cut the meat, make sure the right amount of tension is on the saw blade. There should be no flexibility whatsoever. The feel of the saw blade will be solid when the right amount of tension is applied.
- Meat being sawed should be placed firmly against the sliding tray guide with enough pressure to maintain a uniform thickness of the slices.
- Never use unnecessary force when cutting (sawing) meat. It is possible to break the blade and cause serious injury to yourself or others from flying pieces of metal.
- Always make sure the guide is securely tightened after the adjustment for the thickness of the meat slices has been determined. Set the blade guide 2 inches above the meat.
- Always keep your hands on the part of the meat that is most distant from the saw blade.
- Make sure the blade guard is in place at all times except when cleaning.

Care and Cleaning

The revolving wheels have grease chambers. Pack them frequently. Keep the machine clean. Oil it at least once a week. Always wash and sanitize the machine properly after each use or after every 4 hours of continued use. Use hot soapy water to wash the machine and rinse it with hot water (170°F). Do not drip water on the electric motor.

MEAT CHOPPER

The electric meat chopper is used to chop or grind all meats (cooked or raw) and to prepare bread crumbs from leftover bread and toast. The meat chopper is portable and maybe placed where it is needed most. It should be placed on a sturdy stand within easy reach of an electric outlet.

Operation

Usually a 3/8-inch plate is used for grinding meat. The use of a 3/16-inch plate for such grinding puts too much pressure on the grinder. The cutting edge of the

knife must go next to the plate. Never forcibly tighten the adjustment ring on the chopping end, but tighten it snugly. Excess pressure will wear the chopper parts.

Start the motor, then feed the material into the chopper. Turn the motor off after the material is ground. Feed the material into the machine with the tools intended for that purpose—never with your hands.

Care and Cleaning

After meat has been chopped, take the grinder apart and wash each part thoroughly with soap and water, rinse with hot water (170°F), and allow to air dry. Do not allow food to dry on the surfaces of the chopper before you wash it. A grinder can be a breeding place for bacteria that might cause food poisoning. Great care should be exercised in keeping the parts of the grinder free from contamination.

Knives and plates should be sharpened before they get dull, but do not attempt this yourself. The engineering department should be consulted. It is a good idea to keep the same knife and plate together as they wear to fit each other. Tie them together with a cord after they are used so they will not be mislaid.

Keep the motor dry. Do not grind juicy foods, such as onions, because the juice will be forced back into the gear housing, causing a loss of oil and consequent wearing of gears.

If you are grinding foods such as crackers, grind a very small amount at a time or the machine will jam. When the chopper is hot, do not run raw meat through it. Remember that bits of bones can break the warm gears and knives.

MEAT TENDERIZER

The meat tenderizer is used to tenderize all sorts of tough meats. The machine is about 20 inches long and about 1 foot wide.

To operate, turn the motor on, insert the meat to be tenderized into the opening at the top of the machine. The meat will pass through two sets of revolving rollers that contain many small blades and will be made tender. If further tenderizing is required, insert the meat again after first giving it a one-quarter turn (90 degrees).

Meat-tenderizing machines are equipped with a safety device that automatically stops the machine when the cover (shield) is raised. Never attempt to raise the top with the machine running or to operate the machine with the cover raised because of the danger of catching your fingers in the machine. Take the machine apart and clean it after each use. Oil the parts often.

KNIVES

Many different sizes and shapes of knives are required for meat-cutting jobs. You must understand which knife to use for each job and make sure to use it for the job it was intended. You should never use the thin-bladed knife that is designed for carving cooked meats to bone a roast. It is quicker and more efficient to use the boning knife that has a stiff, narrow, short blade to cut close around bones. The knives with the long, wide blades are used to cut steaks and roasts before they are cooked.

Sharpening Knives

To get the most use out of the knives in the galley, they must be sharp. A dull knife is a hazard and makes extra work for you. A boning knife has a comparatively narrow bevel and will stand more hard use than a steak knife that has a wide bevel and a thin edge. But no matter what tool you use, you cannot do a good job unless the tool is sharp. The butcher's steel is used only to keep the edges of knives straight and not to sharpen them. Nor should you sharpen knives on a power- or hand-driven stone, since this removes the temper from the cutting edge. The best things to use for sharpening are a waterstone and a carborundum oilstone. If you use the entire stone when sharpening tools the stone will not hollow out at any one point. Draw the full blade, from heel to tip, across the length of the stone and then turn the knife over and pull it back from the opposite end of the stone. This sharpens the knife evenly and smoothly and causes the stone to wear uniformly. Always clean the blade and handle thoroughly after sharpening.

Steeling

In steeling, there is a definite technique. Specific types of steels should be used to true certain edges. Never use a rough steel. A smooth steel should be used to keep the blade in perfect condition and to maintain a keen edge. The steel should have good magnetism in order to hold steel particles. The easiest and most effective methods of steeling a knife are as follows:

- Hold the steel firmly in the left hand, thumb on the top of the handle under the guard, with the point upward and slightly away from the body.
- Place the heel of the blade against the top side of the tip of the steel. The steel and the blade should meet at an angle of about 25 degrees.
- With a quick swinging motion bring the blade down across the steel toward the left hand. This should pass the entire edge lightly over the steel.

- Bring the knife into position again but with the blade against the bottom side of the steel. Then, repeat the same motion of passing the blade over the steel.

- Repeat the motion, alternating the knife from side to side; a dozen strokes will true the edge. Steel your knives as often as necessary to keep their edges straight.

Care of Knives

Never throw knives into a drawer with other cutlery or tools. It is a good idea to have a knife rack for each watch fastened to some convenient place in the galley. Do not use knives to open cans, cut wire bands, or open cases of foodstuffs.

DISHWASHING MACHINES

Proper operation and care of dishwashing machines are vital to the sanitation, safety, and efficiency of your

activity, so you must know your machines and follow directions for their use and maintenance.

Dishwashing machines used in the Navy are classified as one-tank, two-tank or three-tank machines. The three-tank machine is a fully automatic, continuous racking machine that scrapes, brushes, and provides two rinses. It is used at major recruit installations and other large activities.

Single-tank Dishwashing Machine

Single-tank machines (fig. 4-13) are used in small ships or small messes whereby installation of larger dishwashing machines is not feasible and practical.

Wash and rinse sprays are controlled separately by automatic, self-opening, and self-closing valves in the automatic machine, or by handles in the manually operated machine. The automatic machine provides for a 40-second wash and a 10-second rinse; for manually

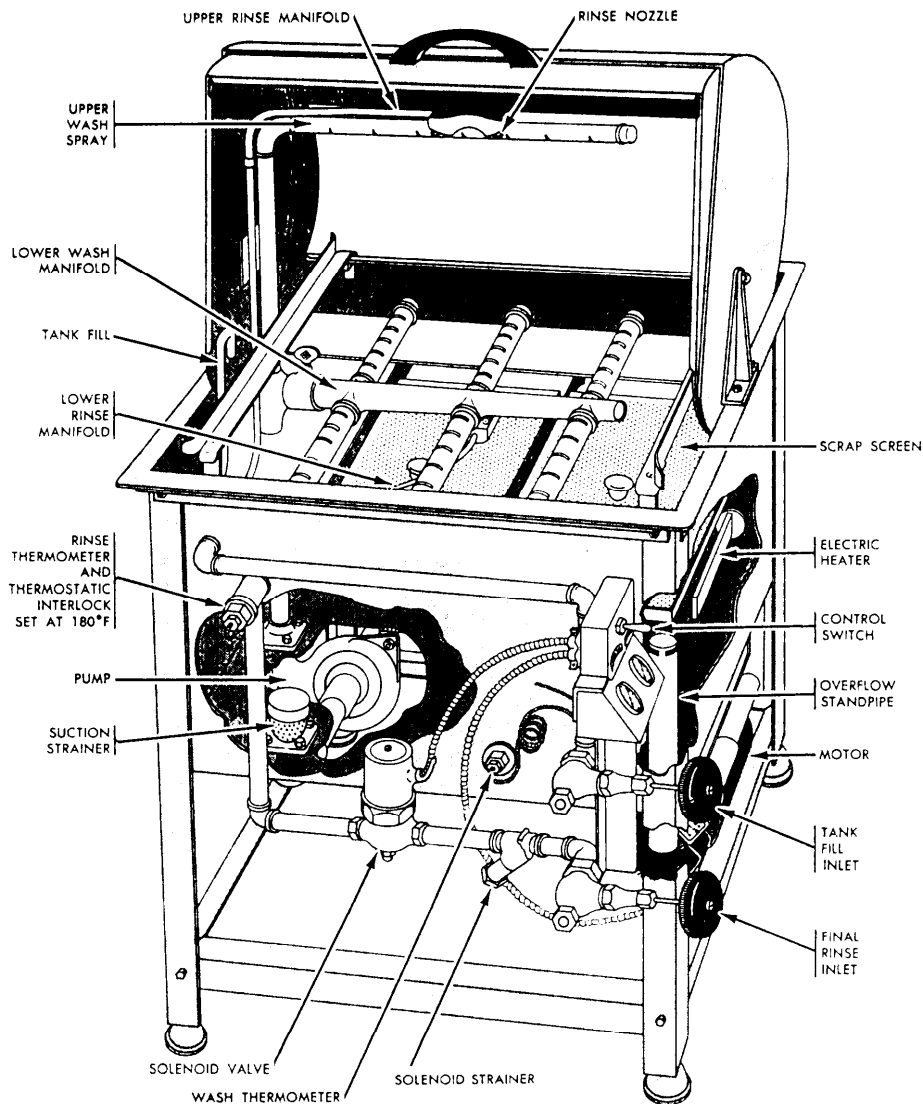

Figure 4-13.—Single-tank dishwashing machine.

operated machines, wash and rinse intervals are controlled by the operator who should allow a 40-second wash and a 10-second rinse.

To control the bacteria to a satisfactory minimum in single-tank machines, it is necessary that the temperature of the wash water in the tank be 140°F to 160°F. Therefore, a thermostat is provided in the automatic machines to prevent operation when the temperature of the water falls below 140°F.

Rinsing is done by means of spraying hot water on the dishes from an outside source and is controlled by an adjustable automatic steam-mixing valve that maintains the temperature of the rinse water between 180°F to 195°F.

Double-tank Method

Double-tank machines (fig. 4-14) are available with several different capacities and are used when more than 150 persons are to be served. These machines are provided with separate wash and rinse tanks. They also have a final rinse of hot water that is sprayed on the dishes from an outside source. This spray is opened by the racks passing through the machine. The spray

automatically closes when the rinse cycle is completed. The final rinse is controlled by an adjustable automatic steam-mixing valve that maintains the temperature between 180°F to 195°F. Double-tank machines are also equipped with a thermostatically operated switch in the rinse tank that prevents operation of the machine if the temperature of the rinse water falls below 180°F. The racks pass through the machine automatically by means of conveyor chains. The two-tank dishwashing machine should be timed so that the utensils are exposed to the machine sprays for not less than 40 seconds (20-second wash, 20-second rinse).

Triple-tank Dishwashing Machines

Some shore activities have triple-tank dishwashing machines installed. The procedures of operation are basically the same as with double-tank machines with the following exceptions:

- The dishwashing machine consists of prewash, wash, and rinse sections with a final rinse.
- Refer to the manufacturer's operating and instruction manual for the preset temperatures of the

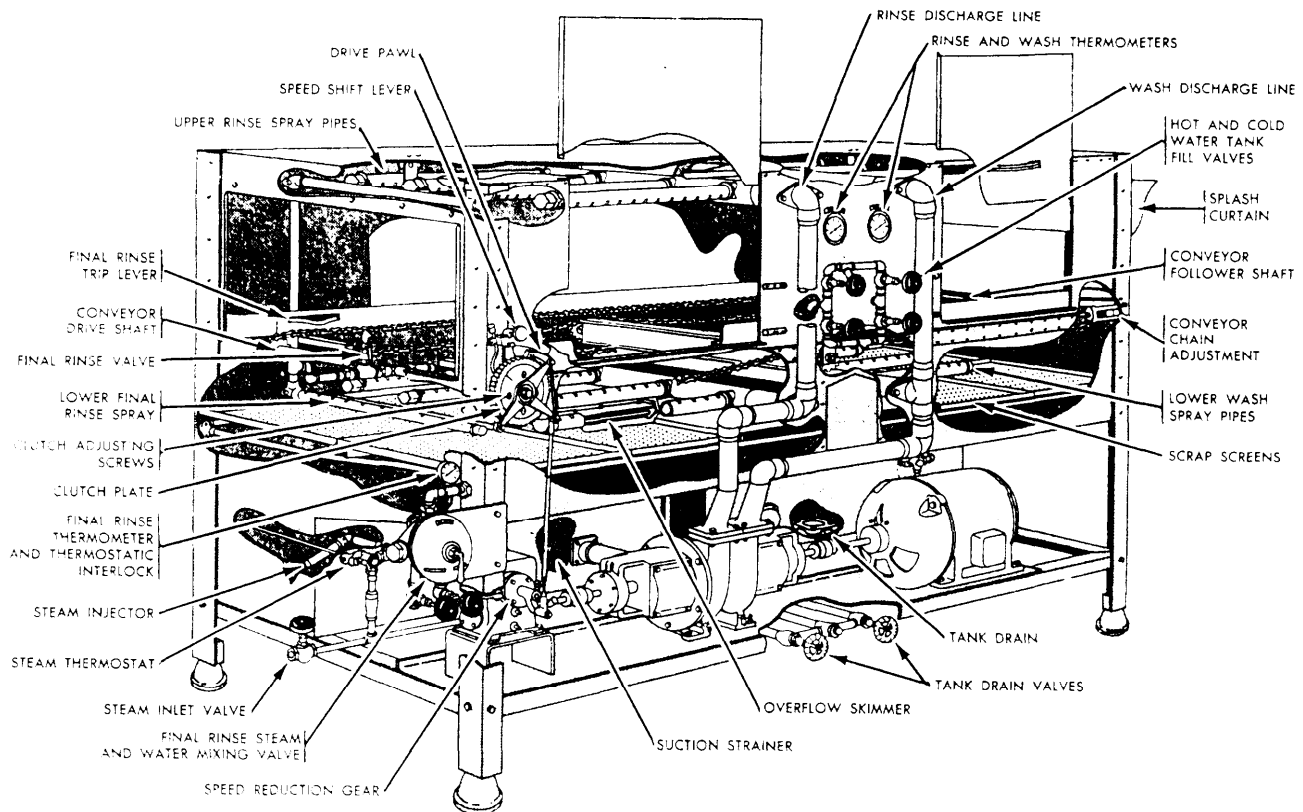

Figure 4-14.—Double-tank dishwashing machine.

prewash, wash, and rinse sections. The final rinse should always remain the same (180°F to 195°F).

OPERATING THE DISHWASHER

The first thing you should do is to read and become familiar with the operating instructions included on the instruction plate that is mounted on the hood of the machine you are operating. Always follow these instructions. Otherwise, you may damage the equipment or injure yourself and others.

The following detailed instructions are given for double-tank machines since most machines in service are of this type. These directions are also generally applicable to single-tank units, except for wash and rinse time intervals and temperatures.

1. Inspect the machine to make sure the scrap screens are in place, spray arms are capped and adjusted so that the spray hits the utensils directly, and splash curtains are in place and not hanging closer than 5 inches to the conveyor.

2. Close the drain valves to the wash and rinse sections of the machine. Open the hot water fill valves and fill the tanks to the full mark on the water level indicator.

3. Open the steam valves and allow the temperature of the water to reach 180°F. Adjust the mixing valve to the HOT position to maintain a temperature range of 180°F to 195°F. On machines with hot water booster heaters installed, open the hot water and steam valve to the booster heater.

4. On machines without automatic detergent dispensers, add the prescribed amount of detergent.

5. Push the START button to start the pumps and conveyor and run the machine for 2 minutes to thoroughly mix the detergent and bring the temperature of the wash tank up to 140°F or above.

6. Look inside the ends of the machine to make sure the power sprays are operating properly.

7. During the operation of the machine keep a close check on the temperature gauges and make sure they are within the following temperature ranges:

- Wash: 140°F - 160°F
- Rinse: 180°F-195°F
- Final rinse: 180°F - 195°F

8. Place the dishrack on the conveyor carefully and allow the conveyor to push the rack through the

machine. If the conveyor is properly set, the utensils will receive a 20-second wash and a 20-second rinse.

9. As the dishrack approaches the end of the machine, it will pass a lever that will actuate the final rinse. Observe the final rinse temperature gauge for correct temperature (180°F- 195°F).

10. Allow all dinnerware and silverware to air dry for at least 1 minute after passing through the machine.

11. Place the clean, air-dried dinnerware and trays bottom side up in a clean storage cabinet or dispenser.

12. Place an empty cylinder over clean, air-dried silverware; invert and place in a clean storage cabinet.

13. For every 30 to 45 minutes of continuous machine operation, the wash tank should be drained and the scrap trays cleaned. Check the machine temperatures frequently using a pocket thermometer (0°F-200°F) to assure the accuracy of the temperature gauges.

The washing of silverware is often unsatisfactory because too much silverware is placed in the rack to be thoroughly cleaned. The proper procedure for washing the silverware is to sort the silver and place 15 to 20 pieces in each cylinder-shaped compartment; run the silverware through the dishwashing machine with the service end up. When the wash-rinse cycle is complete, the sanitized silver should be stored by inverting it in the cylinder-shaped containers; thereby the washing and sanitizing is done without having to touch the utensils.

CLEANING THE DISHWASHING MACHINE

The dishwashing machine must be thoroughly cleaned after each meal or use. The following procedures are to be followed:

1. Turn the machine off.

2. Secure the steam and hot water valves to the final rinse mixing valve, or the steam and hot water valves to the hot water booster heater.

3. Add 3/4 to 1 1/2 cups of dishwashing machine detergent to the rinse tank, depending on the capacity of the rinse tank.

4. Turn the machine on and allow it to operate for 5 minutes.

5. Turn the machine off and secure the steam valve to the rinse tank.

6. Open the drain valves to the wash and rinse tanks; open the doors and allow the machine to cool.

7. Remove the doors, scrap screens, metal frames, wash and rinse spray arms, pump intake strainer, drain strainer, and splash curtains. Wash thoroughly in the utensils wash sink and rinse.

8. Using hand-dishwashing detergent and water with a nylon-bristled brush, thoroughly clean the inside and outside of the machine. Rinse with clean water to remove all loosened dirt and detergent.

9. Reassemble the machine, close the drain valve to the wash and rinse tanks.

10. Fill the tanks one-half full of water, open the steam valve to the rinse tank and allow the temperature to reach 180°F.

11. Turn the machine on and operate for 5 minutes without detergent.

12. Turn the machine off, close the steam valve to the rinse tank, and open the drain valves to the wash and rinse tanks.

NOTE: Follow the same basic procedures for the single-tank dishwashing machine with the exception of steps 1 through 4.

DESCALING DISHWASHING MACHINES

The interior of the dishwashing machine and the manifold(s) should be inspected monthly for accumulation of calcium or lime deposits. If deposits are evident, the machine must be descaled.

Descaling the machine should be a part of the PMS and is the responsibility of the foodservice division. The descaling operation must be closely supervised from start to finish, and personnel must wear face shields, chemical safety goggles, rubber gloves, and rubber aprons when handling acid.

These descaling procedures should be followed:

1. Drain wash/rinse tanks, if applicable.
2. Install overflow pipes, scrap trays, screens, spray manifolds (except final rinse), and curtains (inlet and discharge ends only). Place final rinse spray manifold on top of scrap tray in wash tank.
3. Shut drain valves.
4. Fill tanks to within 2 inches of top of overflow pipes with clean hot water.

5. Add 7 fluid ounces of orthophosphoric acid and 1 fluid ounce of rinse additive for each gallon of water per tank. These items can be obtained through the supply system.

6. Complete filling the tanks and close the doors.

7. Start the machine and operate for 1 hour maintaining normal operating temperatures (150°F- 160°F wash and 180°F-195°F rinse).

8. Stop the machine and open the drain valves. Completely drain acid solution from machine.

9. Inspect the interior of the machine. All the parts should be free of calcium or lime deposits and metal should be shiny.

10. Repeat steps 3 through 8 if necessary.

11. Close drain valves and fill tanks with clean hot water. Add 2 cups of dishwashing compound per tank.

12. Close doors, start machine, and operate for 5 minutes at operating temperatures.

13. Stop machine and completely drain tanks.

14. Refill and flush tanks with clean water to remove all traces of acid and detergent.

NOTES: (1) In the absence of orthophosphoric acid, only USDA-approved chemicals for descaling machine should be used, follow manufacturer's instruction.

(2) If tank capacity in gallons is unknown, multiply length (inches) times width (inches) times depth to overflow (inches) and divide by 231.

(3) Acid drained from the machine should be disposed of according to local regulations (shore stations and ships in port).

GARBAGE GRINDER

Garbage grinders are found in sculleries and deep sinks. They are used to dispose of food from plates, unused food items, and other wet garbage. Always read the operating instructions posted near the grinder before using.

To clean the tank, dump a bucket of strong, hot detergent solution into the tank and scrub the interior. Rinse by flushing the interior walls with hot water. Clean exterior by scrubbing with hot detergent solution, then rinse.

STEAM TABLE

Steam tables are used for serving hot foods. There are several types: (a) those with water compartments heated by steam coils at 40 psi of pressure or less; (b) those with steam-heated water compartments and dish warmers; (c) those with water compartments heated by immersion-electric heating elements; and (d) dish warmers.

Most steam tables used in general and private messes today are immersion-electric heating element types.

Operation

Do not overload food pans. An excessive amount of food makes it difficult to maintain the correct water compartment temperature which is between 180°F to 200°F. If, on the other hand, water in the steam table is allowed to become hotter than 200°F, the food will dry rapidly and continue cooking from the excess heat. You can correct this by adding more water to reduce the heat. Because food tastes best if served within 30 minutes (preferably within 15 minutes) after being placed on the steam table, do not place food pans on the steam table too early.

Care and Cleaning

After each meal, drain the steam table, wash the tanks with hot soapy water, and rinse with very hot fresh water of at least 180°F. Wash the top and front of the steam table to make it bright, clean, and sterile; then wipe it dry with a clean cloth.

ELECTRIC TOASTERS

Electric toasters used in the galley and dining area are the intermittent and rotary types. The intermittent type is composed of chrome-plated steel and has a vertical oven with two to four openings for inserting the bread slices. The continuous type has a chrome-plated heavy-duty conveyor with motor-driven trays for the bread.

Rotary toasters are cleaned by first disconnecting the power. After toaster is cooled, remove pan, slide, and baskets. Use soft brush to remove crumbs from front surface and behind bread racks. Wipe clean frame as far as is accessible with warm hand-detergent solution. Use a nonabrasive cleaner to remove stubborn spots. Clean baskets by boiling in hot detergent water. rinse, and air dry. Then, clean and replace all parts.

SHAPER, POTATO MIX (EXTRACTOR)

Potato shapers are used to reconstitute dehydrated potatoes into formed french fries. They are available with optional shaping heads and a conveyor. Some of the shaper accessories are dicers, onion rings, steak fries, shoestrings, and hash-browns.

Follow the manufacturer's instructions and procedures of operation and cleaning of this equipment.

REFRIGERATORS

Refrigerators are designed for storing foods for short periods of time. Most refrigerators installed aboard ship have movable bars that fit in front of each shelf to keep the contents of the refrigerator from moving or falling out when the door is opened. At sea, food must be stored in such a way that it will not move around when the ship rolls. To keep a refrigerator operating at top efficiency, three things are important:

- Keep it clean.
- Do not overload it.
- Defrost it regularly and properly.

Defrosting

You may defrost the refrigerator on a schedule or when the frost accumulation requires it. The number of times that a refrigerator requires defrosting depends, of course, on the rate at which frost builds up on the cooling unit. Ice formations should never be more than one-fourth of an inch thick because ice and frost act as insulators and reduce efficiency.

Defrosting is done by turning off the refrigerator; removing all food, and blocking the doors open. Defrosting may be speeded up, however, by placing pans of hot water in the freezer compartment. Do not scrape or chip the ice from the cooling coils as they are easily damaged, and do not pour hot water over the ice accumulation to melt it.

Cleaning the Refrigerator

A refrigerator that is not thoroughly clean will quickly develop a bad odor and the foods in it will spoil. Cleanliness avoids the growth of mold and bacteria that often cause food poisoning. A refrigerator should be cleaned at least once a week and after each defrosting. Never use a water hose in cleaning a refrigerator. The

fluid may seep into the insulation and cause permanent damage. The proper cleaning procedures are as follows:

1. Wipe the gaskets around the door of the refrigerator to remove any oil or grease.
2. Wash the inside surfaces and food shelves with a hot detergent solution of water.
3. Rinse them with a warm solution of baking soda, using 1 tablespoon of soda to 4 quarts of water.
4. Dry all surfaces thoroughly after flushing out the drain with hot water.
5. Clean the outside with warm water, rinse, and dry.

Avoid Overloading

Never overload a refrigerator. An overloaded refrigerator cuts down air circulation and is hard to clean. To prevent overloading, limit the amount of food you draw from bulk storage at any one time. When you draw food that must be kept in the refrigerator, do not ask for more than you can store in your ready-service refrigerator.

REFRIGERATED SALAD BAR

Mechanically refrigerated self-service cold food counters with refrigerated (salad bars) storage compartments are procured in various sizes from three- to six-pan compartment capacity with either a single door or double doors underneath storage areas.

Operation

Usually the refrigeration to the top section of the salad bar is controlled by a separate switch. This switch should be turned on approximately 1 hour before putting the salads on the salad bar to allow the temperature to drop below 40°F.

Defrosting and Cleaning

The refrigerated salad bar should be defrosted and thoroughly cleaned after each meal. Steps in defrosting and cleaning are as follows:

1. Turn off the switch of the top unit and allow it to defrost freely. Do not use any metal objects to remove ice as it may puncture the coils.
2. To clean, remove all inserts of salad and dressings and return them to the vegetable preparation room.

3. Discard the ice.

4. Using the two-pan method, you should clean and rinse the salad bar and allow it to air dry. Special attention should be given to the drain to make sure it is free of food particles and is draining properly.

5. To clean the storage section of refrigerated salad bars, follow the same procedures as for the top unit, paying particular attention to the drains and door gaskets.

6. Clean the sneeze shield, legs, and metal frame.

7. Clean the exterior of the salad bar as recommended by the manufacturer's technical manual.

REFRIGERATED MILK DISPENSERS

Refrigerated milk dispensers are used to dispense bulk milk. They are available with one, two, or three dispensing units. The size of the mess and the number of personnel fed will determine which milk dispensing unit is installed.

Operation of the Milk Dispenser

Before loading the machine, you should make sure the temperature range is from 32°F to 40°F. Fill the milk dispenser. Cut the milk dispensing tubes with a clean, sharp, disposable plastic knife at a point one-fourth of an inch below the dispensing valve opening.

Care and Cleaning

After each meal, clean the exterior with a mild solution of hot detergent water, making sure the base of the machine around the legs, metal seams, and the edges under the dispenser opening and door are thoroughly cleaned. Remove and disassemble the metal dispensing valve and run it through the dishwashing machine.

Defrost the milk dispenser when the ice reaches a thickness of one-fourth of an inch using the procedures that follow:

1. Remove milk containers and place them under refrigeration while defrosting.
2. Turn off electric power supply; open the door and allow the machine to defrost freely.
3. Do not use metal objects to dislodge ice.
4. After defrosting, clean the interior of the machine using the two-pan method. One pan contains 2 tablespoons of liquid detergent to each gallon of hot water which is applied with a nylon-bristled brush. Pan

number two contains hot clean water or a sanitizing solution which is applied with a clean sponge.

5. Special attention should be given to the door gaskets to prevent damage and deterioration.

6. After defrosting, cleaning, and wiping dry, you should turn the electric supply back on.

SOFT-SERVE ICE-CREAM MACHINE

This machine is usually located in the messing area and the patrons serve themselves. The MSs are responsible for preparing the ice-cream mix and cleaning and sanitizing the machine. It is a must that the machine be sanitized before and after each use. Follow the procedures of operation according to the technical manual or the operation procedures posted next to the machine.

Cleaning After Each Use

Soft-serve ice-cream machines are very susceptible to a rapid bacterial growth of even a little amount of ice-cream mix left in the machine or on any area the mix contacted. Therefore, following the procedures in cleaning the machine are very important. The procedures are as follows:

1. Empty freezer and flush with cold water until water runs clear.

2. Rinse again with warm water (120°F).

3. Place 1 gallon of hand-dishwashing detergent and water (140°F) solution into the hopper. Move the switch to the WASH position and operate for 2 minutes. Draw off water solution.

4. Rinse the interior of the machine with clean water.

5. Remove all detachable parts, freezer door assembly, and drawoff plunger, beater, blades, and beater drive shaft, mix feed assembly, and hopper cover assembly.

6. Wash all parts in detergent solution and brush all surfaces. Brush inside of freezing cylinder; pay particular attention to the back wall and shaft connection. Rinse all parts thoroughly and allow them to air dry.

7. Store all clean parts in a clean storage area until next use.

Sanitize the Machine Before Use

Prepare sanitizing solution according to package directions on calcium hypochlorite or disinfectant

foodservice. Wear disposable gloves when assembling the machine. Dip each part in solution as machine is assembled. Pour remaining solution into the hopper and brush solution over entire inside and lid. Let the machine runs for 1 minute to allow the solution to run through the mixer. Drain completely and the machine is ready for use.

COFFEE MAKERS

Coffee makers used in the GM are normally electric and may be of different types. The automatic twin coffee urn and the automatic coffee maker (figs. 4-15 and 4-16) are the types used most often in general and private messes.

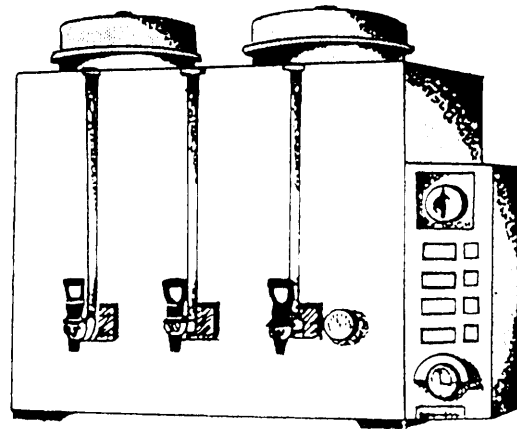

Figure 4-15.—Automatic twin coffee urn.

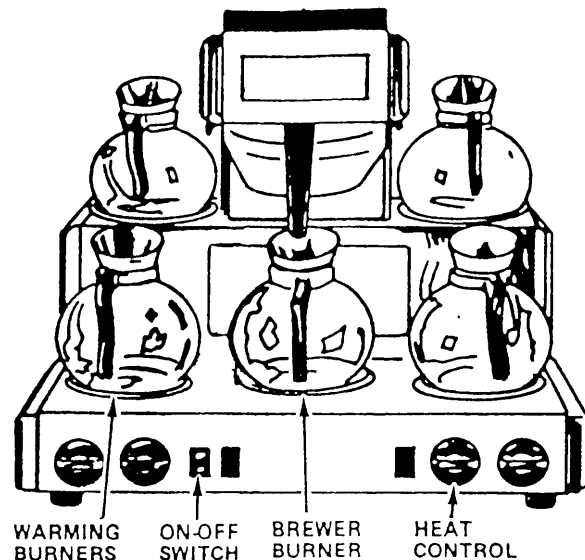

Figure 4-16.—Automatic coffee maker.

Operation of the Automatic Twin Coffee Urn

To brew coffee, turn thermostat dial to the BREW position. Observe dial thermometer on front of the urn. When brewing temperature is at the high end of brew zone on dial, the urn is ready to brew coffee.

Place paper filter or muslin leecher bag in brew basket. Place desired amount of coffee in filter (use urn grind coffee in 3-gallon urn and regular grind in larger urns), replace cover, and place brew basket in position over coffee liner. When using muslin bag, be sure bag is soaked with cold water before using, and, if a new bag, be sure to wash out all sizing with warm water. Swing spray arm from the PARK position over brew basket and center spray nozzle over brew basket. Push timer knob. After the timer has completed its cycle, the orange brewing light will go out, showing that the proper amount of water has been sprayed. Within 3 minutes the brew basket with spent coffee grounds should be removed from urn. To do so, swing spray arm back to center PARK position. The spray arm should always be parked in this center position so expansion drippage will go back into tank. Do not leave the brew basket in liner over 5 minutes, if possible. Remove cover and brew basket and then always replace cover over coffee liner. Rinse out muslin leecher bag and store in cold water until ready to use.

Keep the thermostat dial at the HOLD position during all standby periods so that the urn is ready to brew coffee at any time, with no waiting. Merely turn thermostat to the BREW position so the pilot light lights up during brewing. During shutoff periods, turn thermostat to OFF. After all night or weekend shutoff, a minimum of at least 55 minutes is required to obtain the proper brewing temperature. On twin models, water for tea may be drawn from center faucet. Manual refill is required unless equipped with auto refill.

Care and Cleaning of a Coffee Urn

The procedures used in caring for and cleaning a coffee urn are as follows:

1. Always rinse urn immediately after each use.
2. Add small quantity of hot water, brush sides, and rinse with hot water until it runs clean. Urn is now ready for next batch.
3. At end of each day clean and brush urn several times and then rinse thoroughly with hot water.

4. Remove cleanout cap at end of coffee faucet (or take apart faucets that have no caps) and scrub pipe leading to center of urn. Clean urn gauge glass with brush and urn cleaner. Rinse thoroughly.

5. Scrub the faucet and then rinse it thoroughly with hot water.

6. Place a gallon or more of fresh water in urn until next use.

7. Remove cover and clean. Replace cover and leave partly open.

8. Always remember to empty and rinse the urn with hot water before using again.

NOTE: On automatic urns, use any of the BREW, START, STOP, or RINSE switches to spray scalding hot water into the liner for cleaning and rinsing. On Pour-over urns, draw hot water directly from urn. Make sure urn water tank is kept nearly full and the heat is on.

Destaining a Coffee Urn

The procedures for destaining coffee urns are as follows:

1. Fill urn with destaining compound solution. Fill urn with water 175°F. Add destaining compound (stain remover, tableware, in this ratio: 2 tablespoons per 5 gallons of water or as directed by manufacturer).

2. Draw off mixture and repour. Open spigot and draw off 1 gallon; thoroughly remix to allow mixture to come into faucet. Allow solution to stand for 1 hour at 170°F to 180°F. Stir occasionally.

3. Scrub urn liner and gauge glass. Use long-handled brush to loosen scales.

4. Clean faucet. Take faucet valve apart and clean all components. Soak in hot water until reassembled.

5. Rinse and reassemble faucet valve. Rinse urn liner three or four times carefully with hot water. Repeat until all traces of compound are removed.

Operation and Care of an Automatic Coffee Maker

The automatic coffee maker is designed to brew fresh coffee under strict, sanitary conditions. Each coffee maker is made in units, and each unit may contain four or five burners set in a single or double deck. The coffee maker has the ON/OFF switches and the head control switches on the front. Glass or metal bowl

containers are supplied for the actual brewing of the coffee.

Automatic coffee makers let you pour fresh water into a reservoir at the top of the device to obtain the same amount of hot coffee. In some models, gravity displacement of preheated hot water by cold water is the working rule. In others, water is brought to a boil before brewing a batch of coffee.

In using an automatic coffee maker, there are two phases in making coffee, preheating and brewing. The preheating phase consists of the following steps. Slide the brewing chamber under the spray head and place an empty decanter under it. Then open the top cover and pour two decanters of cold water in the reservoir. Replace cover. Make sure to plug into electric outlet of the correct voltage (specified on the nameplate of device). It should be noted that the two decanters of cold water should be poured in before connecting the plug. Preheat time is usually 18 minutes, and a signal light will turn on when the water reaches the proper brewing temperature.

Brewing good coffee requires skill, technique, and the experience of the skilled foodservice specialist. To properly brew coffee, remove the brewing chamber and place one paper filter in it. Add required amount of the recommended coffee grind. Check to be sure the coffee is evenly leveled before replacing brewing chamber. After the preheating phase, add a decanter of cold water to the reservoir. Coffee will immediately start to brew and flow into the decanter under the brewing chamber. When the flow stops, you are ready to serve.

The simple care of your equipment makes an important contribution to the excellence of your coffee service and efficient use of energy.

All parts of the brewer that come into contact with the coffee and coffee vapor should be kept immaculately clean. Decanters, for example, should be thoroughly cleansed and rinsed free of detergent after each use. Spray heads should be checked regularly for traces of lime or other deposits in or around the holes. It is important to keep them clean.

Paper filters should never be reused as they can pick up odors from other foods. Discard after each brewing process. Be careful where you store them.

Cloth filters should be rinsed after each brew and stored overnight in a vessel of fresh cold water. Replace cloth filters often to ensure good-tasting coffee. A simple sniff test should tell you when it is time to change.

New cloth filters should be cleaned and rinsed in very hot water to remove sizing (starch) and cloth odors. Do not use soap, bleaches, or detergents since they transfer flavors.

If you brew in sealed filter bags with a stainless steel filter screen, rinse out the holding cartridge and screen daily. Once a week soak the screen overnight in a solution of urn cleaner and rinse thoroughly before reusing.

ICED TEA DISPENSER

The iced tea dispenser is used with instant powdered tea and provides a convenient method of serving iced tea at meals.

Operation

Instant tea comes in a sealed jar, ready for use in the dispenser. To get the machine in operation use the following procedures:

1. Remove lid and seal from instant tea jar.
2. Replace with dispensing funnel by screwing it on firmly. Do not touch internal components of funnel assembly.
3. Insert jar and funnel in tea dispenser. It is now ready for operation.
4. To operate, fill a glass with ice and place it directly under the spout. Press the glass lightly against the actuator and hold until glass is filled.

The tea dispenser is preset to produce a beverage suitable for the average consumer but can be adjusted to produce stronger or weaker tea.

Cleaning

Remove bottle and funnel assembly by sliding straight out of coil shield hole, then remove funnel assembly from jar. Using the two-pan method, wipe the exterior components. Empty the drip pans. Wash the drip pan and the grill with mild detergent and warm water. Do not soak plastic parts in hot water or wash in dishwashing machine. To prevent gumming of the instant tea dispenser, make sure all component parts are thoroughly dry before inserting anew bottle of tea. The machine should be cleaned after each meal.

NONCARBONATED BEVERAGE DISPENSER

Noncarbonated beverage dispensers are usually located in the dining area to dispense fruit juices, lemonade, iced tea, and other popular beverages. These dispensers have a self-contained refrigeration unit and a circulating pump to keep the beverages thoroughly mixed and to promote uniform cooling. The beverages are dispensed from a clear plastic tank.

Operation

Fill the tank well in advance of the meal to assure a properly chilled beverage. To facilitate chilling, beverages should be prepared in advance and prechilled. Ice should not be used to chill the beverage at the time of preparation. As a beverage is being dispensed, make sure to empty and clean the drip pans as necessary and wipe up any spillage immediately. Turn off the refrigeration unit and circulating pump when the machine is not in use or the tank is empty.

Cleaning

The dispenser should be disassembled and thoroughly cleaned after each meal or when used. Use the following procedures:

1. Turn off the electric power supply to the machine.
2. Drain the beverage from the dispenser.
3. Disassemble the dispenser. Clean the exterior of the exposed dispenser using the two-pan method. Make sure the base of the dispenser (legs) and the dispensing valve openings are also cleaned.
4. Wash the removed items in warm detergent and water, rinse with clear hot water to remove all traces of detergent, place in a sanitizing solution, and allow to air dry. Do not use any abrasive cleaners and do not place in the dishwashing machine. Reassemble the dispenser after it has air dried.

An extensive weekly cleaning at the base of the dispenser should be done that includes vacuuming inside the unit and wiping the exposed areas of the dispenser. Make sure the power is off and exercise extreme caution when doing this procedure.

BULK ICE-MAKING MACHINE

This machine requires little maintenance by foodservice personnel, but should be closely monitored.

Ice is easily contaminated; therefore, the following strict measures should be taken:

- Only authorized personnel should have access to the machine. The ice bin should be locked.
- The ice scoop should be stored dry outside the ice bin or inside the bin at a height above maximum ice level.

A monthly cleaning is required. Thoroughly clean the interior of the bin with a mild detergent and water solution using a nylon-bristled brush, then flush with clean water until all traces of detergent have been removed. Adequate rinsing with water containing 2-ppm chlorine should be used to eliminate bad odors and the accumulation of film deposits from detergents.

ICE-DISPENSING MACHINE

These machines are highly appreciated by the dining patrons, particularly during the hot months of the year. It is recommended that the machine be secured except during meals to make sure a sufficient supply of ice is available. If the machine becomes empty during service, it should be immediately disconnected or turned off to prevent damage to the dispensing assembly.

To clean the machine without disassembling the unit, you must shut off water, then pour 1 quart of mild detergent solution slowly into water reservoir and let ice form from cleaning solution. Discard ice and shut off the machine. Flush the ice-making system by adding 1 quart of clean water to the reservoir. Discard the ice. Wash down the storage bin with a mild detergent solution and rinse thoroughly with clean water containing 2-ppm chlorine. Areas in and around motor, insulation panels, and condenser coils should be vacuumed to free them of lint and dust. Periodic weekly checks for cockroach infestation should be made.

BENCH-TYPE CAN OPENER

Can openers are often neglected in foodservice. They are used so much that when neglected they could be a ready source of food contamination. Therefore, keeping them in good operating condition and in a high degree of cleanliness is a must.

You must clean the shaft daily and after every use. Simply, lift the vertical shaft out of the base and then soak in hot detergent solution of 1 ounce to 1 gallon of water. Scrub with a stiff-bristled brush. Rinse under hot running water. Let it air-dry. The equipment is now ready for reuse or storing in clean drawer.

CHAPTER 5

FOOD PREPARATION

The objectives of good food preparation are to conserve the nutritive value of the food, to improve the digestibility, to enhance flavor, to develop attractiveness of the original color, shape, form, and texture, and also to free the food from injurious organisms and substances.

Remember that your job as a Mess Management Specialist (MS) is of vital importance to your organization; people must eat to perform their assigned jobs. The end result of your work is for the food to be enjoyed by the patrons of your mess. To achieve this you must continually strive for perfection in providing palatable, wholesome, and attractive food.

This chapter covers some of the what, how, why, and when of food preparation.

BASIC GUIDES

The quality of food prepared in the general mess (GM) and private messes can be controlled to a great extent by the use of management tools. These tools provide guidance for the MSs assigned by giving them a clear understanding of why they are there and how they promote efficiency and quality. These tools are the General Mess Menu, NAVSUP Form 1080, *Armed Forces Recipe Service* (AFRS), NAVSUP P-7, and the Food-Preparation Worksheet, NAVSUP Form 1090.

FOOD-PREPARATION WORKSHEET

The first requisite to good cooking is an accurate knowledge of the items to be prepared. MS personnel have specific instructions on which foods to prepare, the recipe card number, the number of portions to prepare, time to start preparations, special instructions from the leading MS, and serving instructions. These instructions are furnished on the Food-Preparation Worksheet, NAVSUP Form 1090. See figures 5-1, 5-2, and 5-3.

Required Use

This worksheet is required for all GMs; however, GMs having fewer than eight MSs may use a modified food-preparation worksheet (fig. 5-3). GMs with only one MS are not required to use the worksheet.

Preparation

The information listed on the food-preparation worksheet becomes a written directive for passing information from the leading MS to the watch captains and other personnel involved in the preparation of the food. The reverse side of the worksheet may be used to record temperature readings, meat breakout requirements, serving line and scullery temperatures, and any additional information required by the food service officer. The food-preparation worksheet is also a valuable record of the menu for the day. Information that is a "must know" for any person supervising a GM can be posted on it. This information includes the number of persons actually fed and the acceptability of specific menu items. Also, this information is useful when the leading MS prepares future menus and food-preparation worksheets. Refer to NAVSUP P-486, volume I, for detailed instructions on preparing the NAVSUP Form 1090.

The food-preparation worksheet is retained for a period of 1 year for afloat activities and 2 years for ashore activities.

Separate Worksheet

At most large GMs, food-preparation worksheets for each work center are prepared. This eliminates the necessity to include the vegetable preparation room, bakeshop, and meat preparation room on the reverse side of the food-preparation worksheet.

Modified Worksheet

GMs having fewer than eight MSs may use the modified NAVSUP Form 1090. GMs with only one MS are not required to use the worksheet. The modified worksheet is explained in detail in the NAVSUP P-486, volume I.

ARMED FORCES RECIPE SERVICE

The AFRS was developed as a joint effort of all branches of the armed forces with the cooperation of the food industry. It consists of approximately 1,800

SIGNATURE OF LEADING MS		AFLOAT		REVIEWED BY (Signature)	DOCUMENT NO.	DAY	DATE	MEAL	ALLOWED	%	PREDICTED	ACTUAL
FOOD PREPARATION WORKSHEET (4061)		NAVSUP FORM 1090 (REV. 5-82)				Monday	8 Sept	Breakfast	250		182	179
ACTIVITY		LEADING MESS MANAGEMENT SPEC		REVIEWED & RECEIVED BY				Lunch	250		240	245
		INSTRUCTIONS		START PREPARATION	START COOKING	PORTIONS LEFT OVER		Dinner	250		195	187
RECIPE CARD	MENU ITEM	PORTIONS TO PREPARE	ACTUAL PREPARED	INSTRUCTIONS	START PREPARATION	START COOKING	PORTIONS LEFT OVER	ACCEPT ABILITY (%)	COMMENTS/DISPOSITION OF LEFTOVERS	PREPARED	UNPREPARED	
C1	Buttered rolled oats	20	18									
F7	Grilled eggs to order	175	172									
L2	Broiled bacon slices	180	178									
L36	Minced beef on toast	50	56									
Q46-2	Hashed brown potatoes	142	152									
A023	French toast puff	84	82									
D18-7	Glazed doughnuts	200	200	Nite baker will prepare	1130	0500	15	103	Discarded			
AP	Chilled apples	AR	85	Wash before serving				47	Saved			
CN	Chilled grape juice	200	198	Serve in jet-spray machine	1200		20	99	Saved			
P2-1	Chicken noodle soup	85	85	Add chopped parsley (use Chicken base)	0945	1015	6	32	Discarded			
L35	Baked meat loaf	200	204	Slice on line	0730	0815	11	79	Discarded			
O16	w/brown gravy	170	170		0830	0900	15	63	Discarded			
Q57	Washed potatoes	185	200	Start with 50 portions, 50 portion	1000	1020	10	78	Discarded			
Q6-3	Buttered green beans	136	150	batches to follow	1000	1030	27	50	Discarded			
Q17-1	Glazed carrots	75	75		1000	1020	4	29				
M47	Tossed green salad	210	200	Use available fresh vegetables	0830	0900	6	79	Saved			
M58	w/French dressing	95	100			0930	0	41				
M70	w/Thousand Is. dressing	120	100				2	40	Discarded			
M6-3	Grilled ham & cheese sand.	40	47	Grill to order w/5 ahead	1000	1045	7	18	Saved			
AP	Potato chips	AR	85				0	35				
G12-1	Iced Devil's food cake	270	270	Ice w/butter cream icing (G39)			32	97	Saved, serve with dinner			
Q4-1	French onion soup	45	48		1445	1515	2	25	Discarded			
L155-	Southern fried chicken	185	184	Use beef base	1300	1330	6	95	Saved			
O16-2	w/chicken gravy	82	85	Ensure doneness	1445	1500	2	44	Discarded			
Q5-2	Tossed green rice	178	178	Garnish w/pimento strips	1430	1445	6	92	Discarded			
Q6-3	Buttered brussel sprouts	30	27	Use steamer	1515	1530						
Q8-3	Corn on cob	165	165	Warm buns prior to serving	1430	1500						
N30	Simmered franks w/buns	20	20		1330							
M9	Creamy cole slaw	135	125	- Make up early -	1000							
M25	Fruited gelatin	100	100	Nite baker will provide								
H24	Peanut butter cookies	200	200									

ON NORMAL WORKDAYS ONLY ONE WATCH CAPTAIN'S SIGNATURE REQUIRED; ON WATCH-RELIEF DAYS BOTH THE RELIEVED AND RELIEVING WATCH CAPTAINS WILL SIGN.

THE 200 PORTIONS ON L35 WERE BASED ON PREVIOUSLY RECORDED 83% ACCEPTANCE FACTOR AGAINST 240 PREDICTED MEAL ATTENDEES. TO COMPUTE THE 79%, SUBTRACT THE 11 LEFTOVER PORTIONS FROM THE 204 PORTIONS PREPARED WHICH EQUALS 193. DIVIDE 193 BY 245 (ACTUAL NUMBER OF ATTENDEES) WHICH EQUALS 78.8% ROUNDED TO 79%.

Figure 5-1.—Example of an afloat Food-Preparation Worksheet, NAVSUP Form 1090.

ASHORE

FOOD-PREPARATION WORKSHEET (1061)
 NAVSUP FORM 1090 (REV. 6-88)
 SN 0108-LF-501-0301

REVIEWED BY (Signature)		DOCUMENT NO.	DAY	DATE	MEAL	ALLOWED	X	PREDICTED	ACTUAL
LEADING MESS MANAGEMENT SPEC		REVIEWED & RECEIVED BY	REVIEWED & RECEIVED BY		Breakfast				
ACTIVITY					Lunch				
					Dinner				

	RECIPE CARD	MENU ITEM	PORTIONS TO PREPARE	ACTUAL PREPARED	INSTRUCTIONS	START PREPARATION	START COOKING	PORTIONS LEFT OVER	ACCEPT. ABILITY (1/2)	COMMENTS / DISPOSITION OF LEFTOVERS	
										PREPARED	UNPREPARED
BREAKFAST	✓	✓	✓		✓	✓					
LUNCH											
DINNER											

CHECKED BLOCKS ARE REQUIRED ENTRIES ON THE MODIFIED FOOD-PREPARATION WORKSHEET

Figure 5-3.—Required information on a modified Food-Preparation Worksheet, NAVSUP Form 1090.

recipes and variations that have been tested and proven. The AFRS also contains the following:

- Guidance cards with product usage and preparation information
- Color photographs of finished products and some stages of preparation
- How-to-do-it line drawings

Standardized Recipes

All food should be prepared according to the recipes published in the AFRS or the recipes that have been approved by the food service officer. Recipes in the AFRS are printed on 5-inch by 8-inch colored cards.

The use of standardized recipes ensures high quality in food preparation. It also eliminates guesswork and prevents variations in quality and quantity. The use of exact amounts of the various ingredients produces accurate yields, prevents leftovers, and promotes food cost control. The food items needed for the day's menu are requisitioned from the bulk issue room storekeeper by the watch captain.

YIELD.— Each recipe in the AFRS is designed to yield 100 portions; however, the yield of some recipes is given in numbers or volume; for example, 2 pans, 8 loaves, and 6 1/2 gallons, depending upon the food to be prepared.

INGREDIENTS.— Ingredients are listed in the order used. The specific form or variety of each ingredient is indicated; for example:

Flour, general-purpose

Flour, bread

The shape, size, or form of an ingredient is specified; for example:

Ham, cooked, 1/2-inch cubes

Onions, dry, sliced

Nuts, unsalted, chopped

Temperatures of ingredients are specified in many recipes. Descriptive terms are also used; for example:

Egg whites (room temperature)

Liver, sliced, partially thawed

Water, warm (110°F)

MEASURES AND WEIGHTS.— Measures and weights are the exact amount of each ingredient needed for 100 portions. Amounts are listed parallel to the list of ingredients. Quantities of dry ingredients weighing more than 1/2 ounce usually are given as both weights and measures. Most liquid ingredients are measured, not weighed.

On the right side of the Measures column, a blank space has been reserved for inserting the actual amounts of ingredients needed to prepare the number of portions the individual galley needs. These quantities may be inserted in pencil directly on the recipe card and then changed as necessary.

METHOD.— Method describes how the ingredients are to be combined and cooked and represents the best accepted cooking procedures. For example, the method will describe the best way to sift dry ingredients together, to thicken a sauce, or to fold in beaten egg whites. Methods are standardized since the same terms are used wherever the same technique appears. The method contains directions for the most efficient order of work, and eliminating unnecessary tools and equipment and unnecessary steps in preparation.

The directions are stated in simple, clear terms for incorporating the ingredients. Each step begins with an action verb such as dissolve, divide, drain, sift, flatten, cover, pour, sprinkle, or bake. These words are the keys to proper procedures and should be closely followed.

Included under method are specific details such as cooking time.

If certain ingredients are to be set aside for later use, this is so stated. For example, “Gradually add sugar, beat to light, firm peak. Set aside for use in step 6.”

In a few instances, serving suggestions are included under method. For example, “Serve with lemon sauce (Recipe No. K-9) or, if desired, top with whipped cream (Recipe No. K-15).”

ABBREVIATIONS.— The basic abbreviations used in the AFRS are as follows:

Volume:

tsp = teaspoon(s)

tbsp = tablespoon(s)

c = cup(s)

pt = pint(s)

qt = quart(s)

gal = gallon(s)

Ingredients:

A.P. = as purchased

E.P. = edible portion (for example, potatoes, peeled, prepared for cooking)

Temperature:

F = degrees Fahrenheit

Weights:

oz = ounce(s)

lb = pound(s)

Containers:

cn = can(s)

cyl = cylinder(s)

jr = jar(s)

NOTES.— Notes appearing below the recipe contain supplemental information such as possible substitutions for ingredients. Specific techniques are included to supplement information contained in the Method column; for example, “If a candy thermometer is not available, heat mixture in step 1 until it forms a soft ball in cold water.” Serving tips also may be included as notes; for example, “If desired, top with whipped cream (Recipe No. K-15) before serving.” “In step 3, if convection oven is used, bake at 350°F for 20 to 25 minutes.”

VARIATIONS.— Variations are included on many recipes. They describe different ways to prepare the product and constitute a major addition to the total number of recipes contained in the AFRS. Each variation is listed as a separate recipe in the index. For example, the recipe for yellow cake includes these variations: (1) banana-filled layer, (2) Boston cream pie, and (3) chocolate cream. The variations in this instance are named according to the principal ingredient that alters the basic recipe. In other recipes where different cooking techniques are used, these may determine the name of the variation.

Recipe Supplements

Recipe supplements are the written source that explains how to prepare certain types of basic food. Included as recipe supplements are guideline cards, index cards, and index of recipes.

GUIDELINE CARDS.— Guideline cards found in some of the recipe sections are directions for preparing a basic type of food. For instance, a guideline card is

used for the makeup of piecrust for a one-crust pie and a two-crust pie. This guideline card eliminates the need to repeat this information on the many different recipes using piecrust.

Guideline cards in the salad, fish, poultry, and vegetable sections include breakout information and the size, count, and recommended use of products. In other instances, a guideline card is used instead of, or as a summary of, recipe information. For instance, in the Vegetable section guideline cards are included for preparing canned, fresh, and frozen vegetables.

INDEX CARDS.— Index cards are found at the beginning of each section and give a complete listing in alphabetical order by type of food or dish of all recipes contained in that section.

An additional breakdown of the index is given for recipe variations. For example, under Yellow Cake, nine variations are listed alphabetically. Indexes are valuable tools for finding and using appropriate recipes.

INDEX OF RECIPES.— The separate, consolidated index of recipes in the AFRS is a valuable reference for menu planners. The recipes in this index are grouped conveniently as follows:

- A. General Information
- B. Appetizers and C. Beverages
- D. Breads and Sweet Doughs
- E. Cereals and Pasta Products
- F. Cheese and Eggs
- G. Cakes, Fillings, and Frostings
- H. Cookies
- I. Pastry and Pies
- J. Puddings and Other Desserts
- K. Desserts (Sauces and Toppings)
- L. Meat
- L. Fish
- L. Poultry
- M. Salads
- M. Salad Dressings and Relishes
- N. Sandwiches
- O. Sauces, Gravies, and Dressings
- P. Soups
- Q. Vegetables

The General Information section of the AFRS has guidelines for basic information. One of the first things you should do is become familiar with this section. Shown in figure 5-4 is a copy of the general information index card that lists the recipe card number by the basic information topic.

Recipe Adjustments

All the recipes contained in the AFRS are based on a standard of 100 portions. However, the number of patrons served per day (or per meal) changes constantly, requiring changes in the quantities of food being prepared. There are various types of recipe adjustments.

YIELD ADJUSTMENT.— To increase or decrease a recipe to obtain the desired number of portions, it is necessary to obtain a working factor. Multiply the quantity of each ingredient by the working factor and convert the quantity into a workable unit as follows:

Step 1. To obtain a working factor, divide the number of portions desired by 100.

Example:

$$\frac{348 \text{ (number portions desired)}}{100} = 3.48 \text{ (working factor) or}$$

$$348 \div 100 = 3.48.$$

Step 2. To determine the quantity of each ingredient to use, multiply the quantity of each ingredient listed in the recipe by the working factor obtained in step 1.

Example:

$$1.25 \text{ cornstarch (quantity in recipe)} \times 3.48 \text{ (working factor)} = 4.35 \text{ lb cornstarch (quantity to use).}$$

QUANTITY ADJUSTMENT.— A recipe maybe adjusted on the basis of the quantity of an ingredient to be used. To obtain a working factor, divide the number of pounds you have to use by the number of pounds required to yield 100 portions:

$$\frac{102 \text{ lb (quantity to be used)}}{30 \text{ (number pounds to yield 100 portions)}} = 3.40 \text{ (working factor) or}$$

$$102 \div 30 = 3.40.$$

SERVING SIZE ADJUSTMENT.— Recipes may be adjusted to yield a specific number of portions of a specific size as follows:

Step 1. Divide the desired portion size by standard portion of the recipe.

INDEX A. GENERAL INFORMATION No 0			
		Card No.	Card No.
Basic Information			Conversion Charts—Continued
Handling Frozen Foods, Guidelines for.....	A-19		Fruit Bars, Guidelines for..... A-13
Measuring Procedure.....	A-3		Measure Conversion A-16
Terms Used in Food			Metric Conversion, Guidelines for..... A-27
Preparation, Definitions of.....	A-2		Weight Conversion..... A-15
Weight and Measuring			Recipe conversion..... A-1
Equivalents, Table of.....	A-4		Equipment, Guidelines for
Conversion Charts			Convection Ovens..... A-23
Can Sizes, Weights and Measures for.....	A-5		Microwave Ovens..... A-14
Containers, Yields, Canned			Steam Cookers..... A-21
Fruits, Guidelines for.....	A-9		Steam Table, Baking and
Edible Portion Weights as			Roasting Pans,
Purchased Weights			Capacities for..... A-25
Fruits.....	A-7		Tilting Frypans..... A-24
Vegetables.....	A-6		
(FRONT)			
		Card No.	Card No.
Ingredients			Milk, Nonfat, Dry,
Antibrowning Agent, Use of.....	A-20		Reconstitution Chart..... A-10
Egg Equivalents, Table of	A-8		Onions, Dehydrated, Use of..... A-11
Flours, Guidelines for Use.....	A-18		Parley, Dehydrated, Use of..... A-11
Garlic, Dehydrated, Use of.....	A-17		Soup and Gravy Base,
Garnishes, Guidelines for.....	A-22		Reconstituting..... A-12
Green Peppers, Dehydrated, Use of	A-11		Menu Planning
Horseradish, Dehydrated, Use of	A-17		Calories, Guidelines for..... A-26
(BACK)			

Figure 5-4.—General information card (front and back).

Example:

$$\frac{3 \text{ oz (desired size)}}{4 \text{ oz (standard portion size)}} = 0.75 \text{ (size factor) or}$$

$$3 \div 4 = 0.75.$$

Step 2. Multiply the number of portions needed by the size factor and divide the answer by 100 to obtain the working factor.

Example:

$$348 \text{ (number portions desired)} \times 0.75 \text{ (size factor)} = 261.$$

$$\frac{261}{100} = 2.61 \text{ (working factor) or } 261 \div 100 = 2.61.$$

Step 3. Multiply the quantity of each ingredient in the recipe by the working factor to determine the quantity to use.

Example:

2 lb cornstarch (quantity in recipe) x 2.61 (working factor) = 5.22 lb cornstarch (quantity to use).

Volume Adjustment

First obtain a working factor by dividing the number of servings needed by 100 as shown in step 2.

$$333 \div 100 = 3.33.$$

Then multiply the quantity of each ingredient by the working factor. You will round off to the nearest 1/4 teaspoon. For example, the recipe calls for 6 gallons of water per 100 portions. Portions to prepare are 333.

$$333 \div 100 = 3.33 \text{ working factor (w/f).}$$

Step 1. w/f x gallons (recipe) = gallons to use

$$\begin{array}{r} 3.33 \text{ w/f} \\ \times 6 \text{ gl} \\ \hline 19.98 \text{ gl} \end{array}$$

Step 2. Decimal (of gal) x 4 = quart

$$\begin{array}{r} .98 \text{ gl} \\ \times 4 \text{ qt} \\ \hline 3.92 \text{ qt} \end{array}$$

Step 3. Decimal (of quart) x 2 = pint

$$\begin{array}{r} .92 \text{ qt} \\ \times 2 \text{ pt} \\ \hline 1.84 \text{ pt} \end{array}$$

Step 4. Decimal (of pint) x 2 = cup

$$\begin{array}{r} .84 \text{ pt} \\ \times 2 \text{ c} \\ \hline 1.68 \text{ c} \end{array}$$

Step 5. Decimal (of cup) x 16 = tablespoon

$$\begin{array}{r} .68 \text{ c} \\ \times 16 \text{ tbsp} \\ \hline 10.88 \text{ tbsp} \end{array}$$

Step 6. Decimal (of tbsp) x 3 = teaspoon

$$\begin{array}{r} .88 \text{ tbsp} \\ \times 3 \text{ tsp} \\ \hline 2.64 \text{ tsp} \end{array}$$

Step 7. Round off tsp decimal portion .64 tsp is equal to 3/4 tsp

Thus, the amount of water needed for 333 portions is 19 gl, 3 qt, 1 pt, 1 c, 10 tbsp, and 2 3/4 tsp.

CONVERTING AND ROUNDING CALCULATED QUANTITIES.— When a recipe is increased or decreased or ingredient quantities are altered it is

usually necessary to convert the amount calculated to another unit of measure because, in most instances, a part of a pound or a partial measure results. To obtain a usable figure, (a) round off the calculated figure given in decimal pounds or measures to a whole figure or (b) convert partial pounds into ounces and the partial measures into smaller units; for example, partial quarts into cups.

CONVERTING FRACTIONAL WEIGHTS.—

When increasing or decreasing recipes, the division or multiplication of pounds and ounces is expressed as decimals to simplify cumbersome fractions. For example, if the quantity of an ingredient is multiplied by a working factor, the calculation is as follows:

$$1.25 \text{ lb} \times 3.48 \text{ (working factor)} = 4.35 \text{ lb.}$$

The quantity, 4.35 pounds, could be expressed by converting the fractional part of the pound into ounces.

Another means of converting fractional parts of a pound is to make the calculation instead of consulting the conversion table. The part of the pound is converted to ounces by multiplying the figure by 16 ounces.

$$\text{For example: } 0.35 \times 16 \text{ oz} = 5.60 \text{ oz.}$$

ROUNDING OFF WEIGHTS.— After the part of the pound has been converted to ounces (0.60), as indicated in the Recipe Conversion Card A-1(1), decimals may be rounded off to provide whole units of weights or measure. Round off decimal weights as follows:

<u>Decimal</u>	<u>Round to</u>
0.01 to 0.12.....	.00 or oz
0.13 to 0.37.....	0.25 or 1/4 oz
0.38 to 0.62.....	0.50 or 1/2 oz
0.63 to 0.87.....	0.75 or 3/4 oz
0.88 to 0.99.....	1.00 or 1 oz

Using the previous example, the 4.35 pounds (or 4 pounds 5.60 ounces) would be rounded to 4 pounds 5 1/2 ounces.

ROUNDING OFF VOLUME MEASURES.—

When converting volume measures, rounding off is also necessary. Round off volume measures as follows:

<u>Calculated volume</u>	<u>Round to</u>
5 gal or more.....	Closest full qt
5 1/4 qt to 4 3/4 gal.....	Closest full cup

5 1/4 cups to 5 qt Closest full 1/2 cup

2 3/4 to 5 CUPS Closest full 1/4 cup

If the quantity being measured is less than a quart, it is more practical to adjust the volume to tablespoon and teaspoon measures as follows:

Calculated volume

measure

Round to

1 1/4 to 2 1/2 cups Closest tbsp

9 tbsp to 1 cup 3 tbsp Closest tsp

5 to 8 tbsp Closest 1/2 tsp

Under 5 tbsp Closest 1/4 tsp

To convert volume measures from gallons, quarts, cups, tablespoons, and teaspoons, see figure 5-5.

Measuring Utensils.— Measuring utensils include both measuring spoons and volume measuring pitchers. Measuring spoons (fig. 5-6, view A) are used for both liquid and dry ingredients and come in four basic sizes. Measuring pitchers (fig. 5-6, view B) also come in four basic sizes (gallon, quart, pint, and cup) and are described as follows:

1. The 1-gallon measure is used mostly for liquids. Markings go completely around the utensil in 1-quart increments.
2. The 1-quart measure is used mostly for liquids. Markings go completely around the utensil in 1-cup increments.

3. The 1-pint measure is used mostly for liquids. Measurement markings go completely around the utensil in 1/2-cup increments.

4. The 1-cup measure is used for both liquid and dry ingredients. Measurement markings are on both sides.

a One side is marked in 1/4-cup, 1/2-cup, 3/4-cup, and 1-cup increments.

b. The other side is marked in 1/3-cup, 2/3-cup, and 1-cup increments.

Measuring utensils are accurate and easy to use. However, they must be used properly to obtain high-quality products. Figure 5-7 shows the measurement equivalents for both types of measuring utensils.

Even Balance Scale.— The even balance scale (fig. 5-8) is normally used to weigh solid and dry ingredients before mixing. It may also be used to weigh products shaped or formed during preparation to ensure portion control.

Figure 5-8 also shows the parts of the even balance scale. These parts are explained as follows:

1. The stand (or base) supports the entire mechanism.
2. The weight plate is where the counterweights are placed for weighing ingredients.
3. The location of the slide bar and the scoop plate.

GALLONS	QUARTS	PINTS	CUPS	FLUID OUNCES	TABLESPOONS	TEASPOONS
1.00	4.0	8.0	16.0	128.0	256.0	768.0
.50	2.0	4.0	8.0	64.0	128.0	384.0
.25	1.0	2.0	4.0	32.0	64.0	192.0
.12	.5	1.0	2.0	16.0	32.0	96.0
.06	.25	.5	1.0	8.0	16.0	48.0
....	.125	.25	.5	4.0	8.0	24.0
....125	.25	2.0	4.0	2.0
....125	1.0	2.0	6.0
....5	1.0	3.0
....33	1.0

Figure 5-5.—Equivalents of volume measurements.

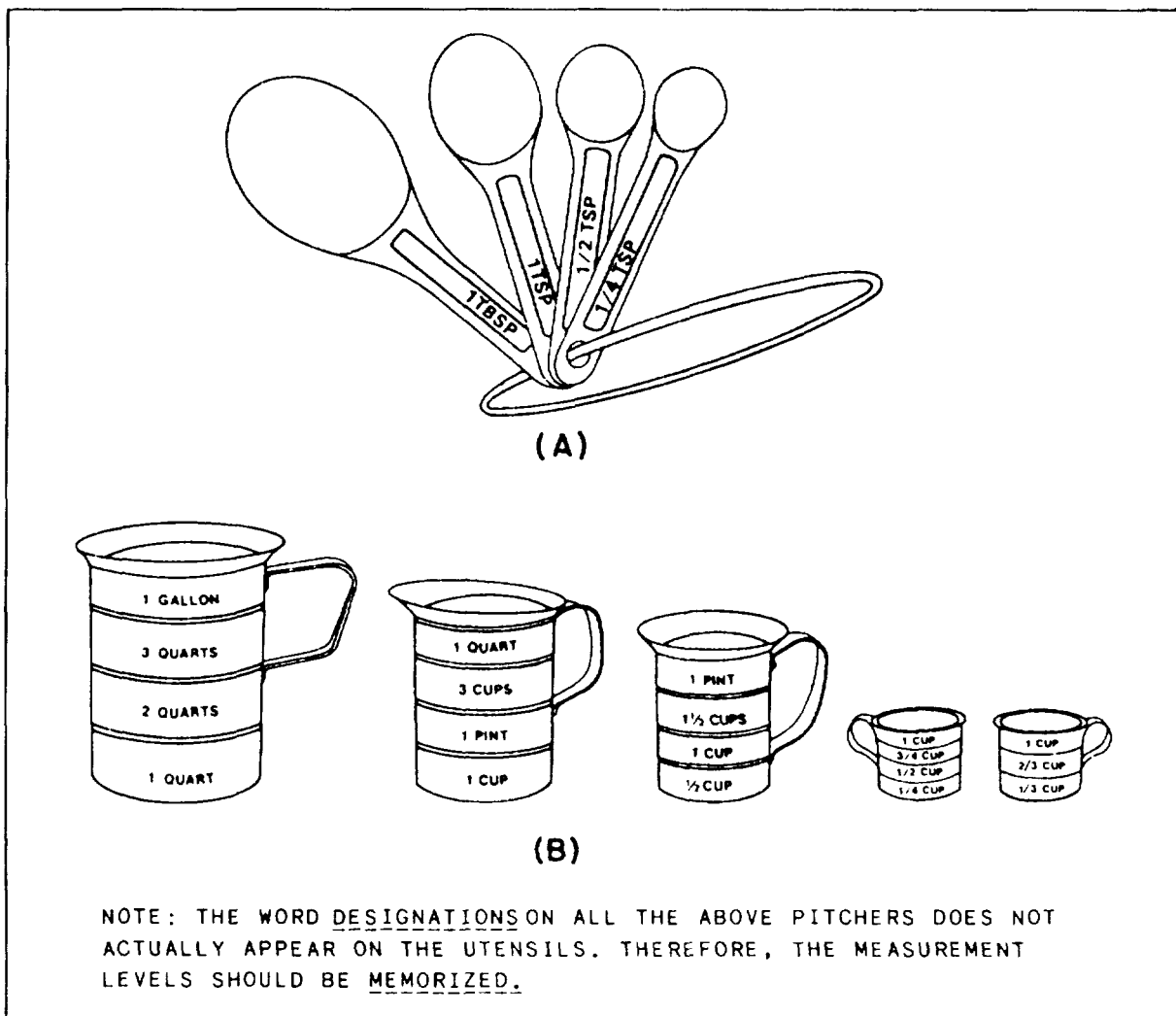

Figure 5-6.—Measuring utensils (views A and B).

4. The scoop holds ingredients being weighed. The scale must be balanced to the scoop (as explained later).

5. The slide bar is divided into 1/4-ounce increments.

6. The basic scale, with scoop, can weigh amounts from 1/4 ounce to 16 ounces.

7. Counterweights placed on the weight plate weighing more than 16 ounces come in 1-, 2-, and 4-pound sizes. Maximum capacity of the scale with counterweights is 8 pounds.

BALANCING THE SCALE.— The procedures used to balance the scale are as follows:

1. Place scale on a level surface; then add scoop.
2. Move the slide bar weight completely to the left.

3. Balance the scale to the scoop. If the scale is badly out of balance, lead pellets should be added beneath the weight plate.

USING THE EVEN BALANCE SCALE.— To use the scale proceed as follows:

1. Place wax paper in scoop.
2. Add weights, as required, to weight plate of scale.
3. Adjust slide as required.
4. Place ingredients on wax paper until scale balances.
5. Remove wax paper with ingredients from the scoop and set it aside.

CARE OF THE SCALE.— Wipe the scale with a damp cloth or sponge. Never put the entire scale into the deep sink because it will eventually rust.

YOU SHOULD REMEMBER EACH OF THE EQUIVALENTS, SINCE YOU WILL USE THE EQUIVALENTS WHEN ADJUSTING RECIPES.

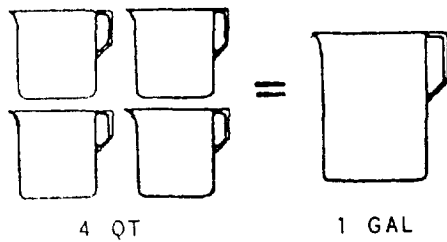

4 QUARTS = 1 GALLON

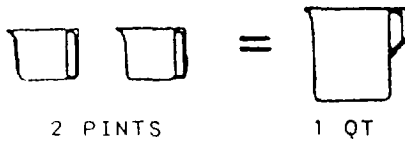

2 PINTS = 1 QUART

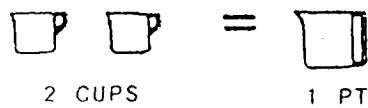

2 CUPS = 1 PINT

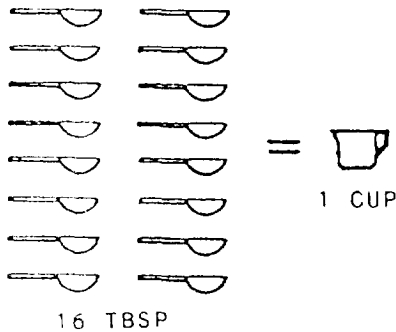

16 TABLESPOONS = 1 CUP



3 TEASPOONS = 1 TABLESPOON

Figure 5-7.—Equivalents of measures.

BASIC FOOD PREPARATION

Cooking is the art of preparing food in such way that it will appeal to the eye, be tasty, be easily digested, and furnish nourishment. This section provides information on food types, methods of cooking, and specific preparation techniques that may be used to produce high-quality products. The sanitary aspects of food preparation will be considered first.

SANITARY ASPECTS

Every precaution should be taken in the handling of food to prevent contamination. The following

paragraphs explain the procedures that must be followed during the preparing and handling of food.

Safe Holding Temperatures for Cooked Foods

Protein foods that are not served immediately after they are cooked must be either chilled to temperatures of 40°F and lower (but not frozen) or held at 140°F and higher. Protein foods include meats, fish, poultry, gravies, meat stock, soups, eggs, custards, cream fillings, and milk.

Cooked protein foods that have been held at temperatures between 40°F and 140°F for more than 4

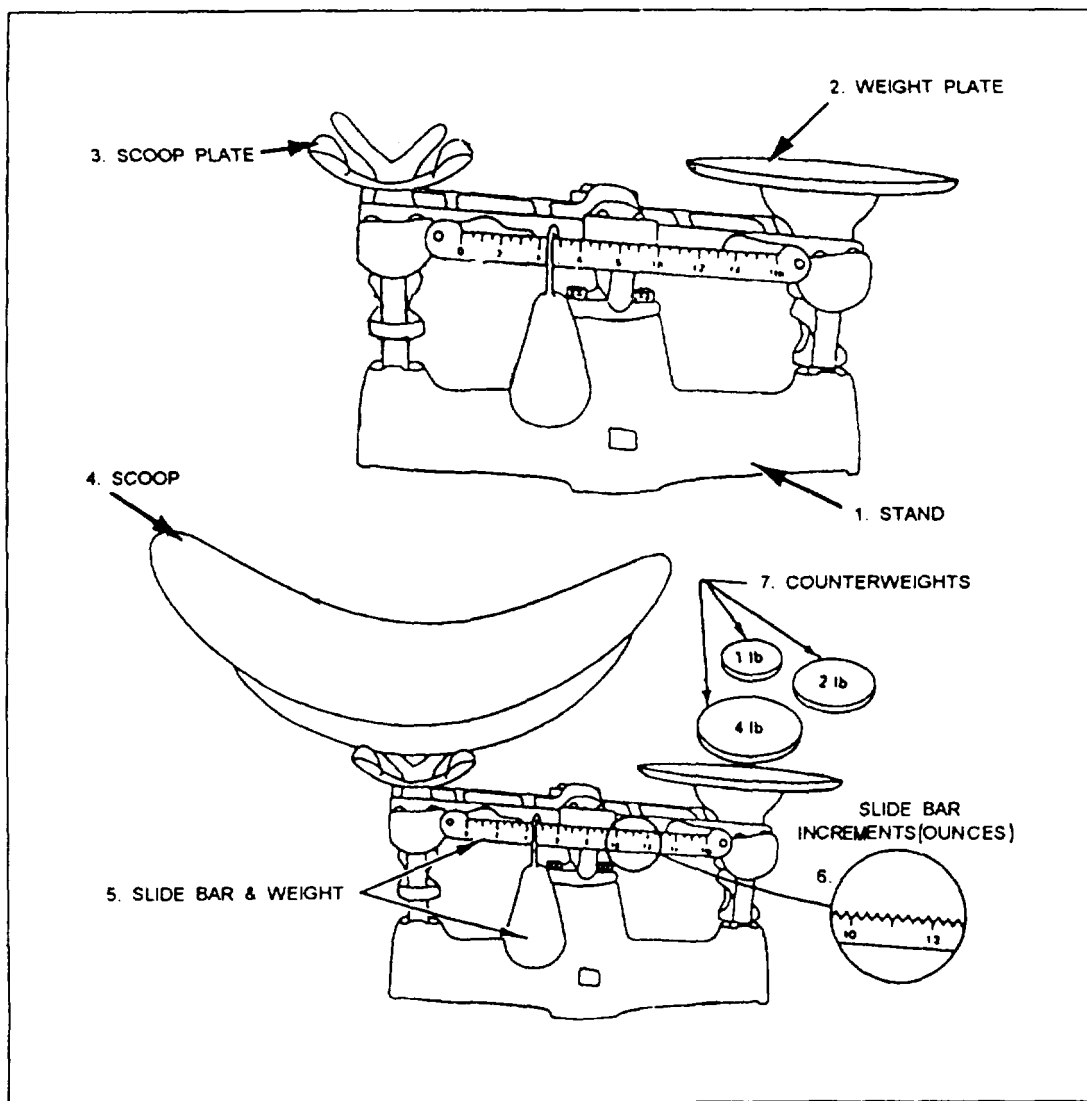

Figure 5-8.—Even balance scale.

hours should be considered unsafe for consumption and discarded. The exception to this rule is reconstituted dehydrated egg mix. Reconstituted egg mix, if not used immediately, must be placed in a tightly covered container in the refrigerator and used within 1 hour. If foods are refrigerated at intervals and then intermittently permitted to warm up, the total time of the various periods between 40°F and 140°F must not exceed 4 hours. Protein foods composed of ingredients that are hand-peeled, hand-sliced, or hand-diced after they are cooked should never be used as leftovers. The 4-hour limit between temperatures of 40°F and 140°F is usually taken up in preparing, chilling, and serving these foods. Such foods include, but are not necessarily limited to, potato, chicken, turkey, macaroni, shrimp, and egg salads. Hand preparation not only increases the chances

of contamination, but also increases the length of time that these foods have been held at room temperature.

You should not return opened jars or bowls of mayonnaise and cooked salad dressings from salad bars to refrigerators for reuse at a later meal because of the danger of miscalculation of total lapsed time that these salad dressings have been held at temperatures between 40°F and 140°F. Instead, mayonnaise and cooked salad dressings should be placed on the salad bar in small quantities and must not be returned from the salad bar for reuse. If economically feasible, individual packets or servings of items such as catsup, mustard, and mayonnaise should be used on the salad bar. This will prevent waste and be more sanitary.

Care of Leftovers

When leftovers or warm foods are chilled, care should be taken to ensure prompt and thorough chilling (40°F or below) to the center of the food mass. Foods that are to be refrigerated should be placed in shallow pans to a depth of not more than 3 inches and should be covered with lids or waxed paper. Large deep pans must not be used since the center of the food may remain warm long enough to permit the growth of harmful bacteria. Foods to be chilled must be placed in the chill box immediately and the containers labeled with the time and date of preparation. Do not save leftovers for more than 36 hours. Freezing leftovers is prohibited.

EGGS

Eggs are a valuable food. They contain minerals, vitamins, and protein that build new body tissues, repair old tissues, and regenerate the blood. Eggs are easily digested and, if properly cared for and properly prepared, are delicate in flavor.

Forms of Eggs

The Navy procures eggs in the following forms:

- Fresh eggs are procured in two types, those that are no more than 30 days old and those that have been treated with oil or other processing fluids so they have a storage life of up to 6 months when refrigerated. Both types should be stored at 29°F to 32°F in a dry, well-ventilated place away from strong odors such as onions.

When several fresh eggs are to be used, break each one separately into a small dish. Thus any egg that may have a strong odor or poor appearance can be discarded without spoiling the others.

- Three kinds of frozen eggs are available: whole table, whole bakery, and frozen egg whites. To thaw frozen eggs, place them in a chill or thaw box at 36°F to 38°F, or place them in a sink and cover the container with cold water. Thirty-pound cans will take 2 days or more to thaw. A day or more is required to thaw 10-pound cans or cartons at 36°F to 38°F. Do not thaw frozen eggs at room temperature. The outer edges will reach a temperature where bacteria can grow, while the center of the container will remain frozen.

Once the eggs are thawed, they are very perishable. Any leftover thawed eggs should be placed in a tightly covered container in a refrigerator and used within 24 hours. Do not refreeze thawed eggs.

Frozen whole table-type eggs should be used for scrambled eggs and omelets. The bakery-type frozen eggs and frozen egg whites should be used only in baking. Egg whites that are used in pie meringues must be baked as a precaution against food-borne illness.

- Dehydrated egg mix is prepared from fresh whole eggs, nonfat milk, vegetable oil, coloring material, and salt. The mix may be used to make scrambled eggs and omelets, French toast, griddle cakes, and can be used in place of fresh eggs in baked foods, Reconstituted egg mix, if not used immediately, must be placed in a tightly covered container in the refrigerator and used within 1 hour. Dehydrated egg mix cannot be used in uncooked dishes.

Egg Preparation

Guidelines for preparation of raw (fresh) eggs are contained in the NAVSUP P-421. These guidelines are provided because fresh eggs that have been contaminated with salmonella cause outbreaks of food-borne illness. The concern remains for batch preparation of whole, fresh eggs for recipes that are uncooked or almost cooked.

Principal policies for preparing eggs are summarized next:

- Eggs not cooked to heat all parts to 165°F or above will be individually cooked and served only upon the request of a patron. Break no more than six eggs per holding bowl. Use a clean sanitized bowl for each six eggs.

- Serving raw eggs and foods containing raw eggs is prohibited.

- Recipes requiring uncooked eggs such as mayonnaise, egnog, and ice cream, will be prepared using only pasteurized frozen table eggs.

- French toast will be prepared using only pasteurized frozen table eggs or pasteurized dehydrated egg mix.

- Scrambled eggs in bulk amounts may be prepared using pasteurized frozen table eggs, pasteurized dehydrated egg mix, or fresh shell eggs. If fresh shell eggs are used, the following provisions are required:

Cook bulk amount of scrambled eggs in small batches, no more than 3 quarts, until there is no visible liquid egg.

Hold until served at 140°F or higher, such as on a hot food table.

Do not add a batch of just cooked scrambled eggs to the batch held on a hot food table. A clean sanitized container is required for each 3 quarts of scrambled eggs.

- Egg-breaking machines will not be used by Navy and Marine Corps foodservice facilities.

Cooking Methods

The AFRS has recipes with detailed procedures for cooking omelets and for fried scrambled, poached, and soft- and hard-cooked eggs. Key steps for each of these are summarized as follows.

FRIED EGGS.— Fried eggs are made using only fresh shell eggs. Cook them gently until the white is firm. Fried eggs must be cooked at low temperatures. High temperatures will cause them to be tough. Eggs may be fried in greased pans in the oven. Oven-fried eggs require a slightly longer cooking time than those cooked on a griddle.

SCRAMBLED EGGS.— Scrambled eggs maybe made from fresh eggs, frozen whole table eggs, or dehydrated egg mix. Chopped ham or shredded cheese can be added for variety. If scrambled eggs are prepared in bulk for service from steam table inserts, you must follow the provisions set forth in the Safe Egg-Handling Guidelines contained in NAVMED P-5010.

POACHED EGGS.— Poached eggs are prepared by breaking a fresh shell egg into a small bowl and slipping it from the bowl into boiling water. Then reduce the heat and allow the egg to simmer until the white is fully formed. Finally, remove the poached egg from the water with a perforated spoon.

SOFT-COOKED EGGS.— Remove eggs from the refrigerator about 30 minutes before cooking. Leave the eggs in the shell. Place them in a wire basket and lower the basket into hot water. Bring to a boil; reduce heat; simmer the eggs for 4 minutes.

HARD-COOKED EGGS.— Hard-cooked eggs may be served whole and unpeeled for box or bag lunches, sliced or quartered in salads, as a garnish, or as an ingredient in dishes such as potato salad. Simmer 10 to 15 minutes.

Place hard-cooked eggs in cold water immediately after cooking. This will prevent the yolk from discoloring. Leave them in their shells if they are to be stored in the refrigerator after cooking. They may

darken if peeled ahead of time. Leftover, hard-cooked egg yolks may be used to garnish green salads, potato salad, macaroni salad, or cooked vegetables. To prevent the yolk from crumbling when slicing hard-cooked eggs, dip the knife into cold water before slicing.

OMELETS.— Omelets are prepared from fresh whole eggs, frozen whole table eggs, or dehydrated egg mix. The eggs are beaten just enough to blend the yolks and whites. Crumbled bacon, shredded or ground cheese, chopped ham, mushrooms, or vegetables may be added for variety. Individual portions of the eggs are poured onto a greased griddle. The omelet is not stirred during cooking, but is lifted to allow the uncooked portion to flow onto the hot griddle. When the omelet is set, it is folded in half or into thirds, then must be allowed to fully cook.

FRUITS AND VEGETABLES

Fruits and vegetables are complex carbohydrates that provide important vitamins, minerals, and dietary fiber. Additionally, they provide pleasant contrasts in flavor, texture, and color to meals.

Fruits

Fruit is procured by the Navy in the fresh, frozen, canned, dehydrated, and dried states. Fresh and processed fruits may be combined to vary the flavor and texture.

Every daily menu should include some fruit. It adds color, variety, food value, and a refreshing flavor to any meal. Fruit is among the least expensive and the most nutritious of all foods and has the distinction of being the most versatile. At breakfast fruit can be served alone or in combination with cereal. It can be prepared as appetizers, salads, main dishes, relishes, desserts, or snacks. It is excellent as a garnish and sometimes acts as seasoning. Fruit is an active partner in many meat dishes. Baked ham and pineapple are often teamed together, as are pork and applesauce, or turkey and cranberry sauce.

FRESH FRUITS.— Fresh fruits are highly perishable and must be handled carefully to maintain quality. Some fruits are available year-round. Others are available seasonally, such as melons and berries.

Before fresh fruits are used, wash them thoroughly to remove any insect spray that may be present. If possible, pare fresh fruits immediately before they are used. When pared and left exposed to the air, some fresh fruits become discolored. Discoloration may be

prevented by covering the fruit with lemon juice, or by dipping the fruit in a antibrowning agent. Follow the directions on the guideline cards for antibrowning agents or those on the actual container.

FROZEN FRUITS.— Frozen fruits are convenient and available year-round. Little preparation is needed, there is no waste, and less storage space is required than for fresh fruit. Most frozen fruits are packed with sugar or syrup. Thaw them in the unopened container and use immediately to maintain quality.

The Navy procures frozen fruits such as berries (strawberries, boysenberries), cherries, and peaches. Frozen fruits are closest to the fresh counterpart in flavor and appearance. They may be thawed by placing the unopened container in the chill space 24 hours before they are to be used. This allows the frozen fruit to thaw completely and more evenly throughout.

CANNED FRUITS.— Canned fruits require no refrigeration and are available all year. They may be packed in water, syrup, or natural juices. All canned fruits should be served chilled.

DRIED FRUITS.— Dried fruits, such as raisins, apricots, prunes, and dates, can be used for pastry and pie fillings and as ingredients in cakes, cookies, breads, sweet doughs, and salads.

Wash dried fruits thoroughly before they are used. They may be soaked to reduce cooking time, but avoid a long soaking period because it produces a watery, tasteless fruit. Cook raisins and dates without soaking. If sugar is to be added, it should be at the end of the cooking period. If it is added at the beginning, it interferes with the absorption of water.

DEHYDRATED FRUITS.— Dehydrated fruit, such as applesauce, maybe used in some recipes when fresh or canned fruit is not available. Check the AFRS for directions.

Dehydrated fruits, such as instant applesauce, apple slices, and diced apricots, are readily reconstituted by adding a proportionate volume of water to a specified weight of the particular dehydrated fruit. Like the dehydrated vegetables discussed earlier, dehydrated fruits because of their small weight and volume are convenient to store. Dehydrated fruits maybe used for desserts such as puddings, pies, and cakes, or they may be reconstituted and served at any meal.

Vegetables

Vegetables of all types are nutritional necessities in a well-balanced diet. In addition to the contribution of

important minerals and vitamins, vegetables add color, flavor, and interest to meals. All too frequently vegetables are rejected or left uneaten when they are poorly cooked; consequently, they are not pleasing in appearance or flavor. A vegetable can become unpopular simply from being overcooked, watery, or poorly seasoned. Furthermore, the food value may be lost or diminished by improper handling and cooking. Vegetables are bought by the Navy in the following forms: fresh, frozen, canned, dried, and dehydrated.

FRESH VEGETABLES.— Most raw fresh vegetables have waste or portions that are not edible. When you peel, scrape, brush, trim, or cut these vegetables, it is important not to destroy or damage edible portions and especially not to lose the valuable nutritional elements that are usually contained close to the outer skin or peel. Select vegetables about equal in size, or cut them into pieces of equal size. Then all the pieces will be cooked uniformly in the same length of time. Plan for cooking vegetables with the peel on whenever possible, especially potatoes. If potatoes must be peeled, do it very carefully so as to make thin peelings. Much of the food value in a potato lies close to the skin.

Washing.— Wash all fresh vegetables thoroughly. Use a brush to clean celery, carrots, beets, potatoes, turnips, parsnips, or any vegetable that is pulled or dug from the soil. Tightly grown blossoms, heads, or stem-type vegetables such as asparagus, broccoli, cabbage, cauliflower, and brussels sprouts will harbor worms and insects that may not be dislodged by casual washing. Soak vegetables of this type in cold saltwater (1 tablespoon salt to 1 quart of water) for 1/2 to 1 hour and then rinse thoroughly. Turn cauliflower blossoms end down in the soaking water; cut cabbages in halves or quarters and remove the cores.

Wash leaf-type vegetables such as spinach, collards, kale, and turnip greens in several changes of cold water to remove dirt and sand particles. Lift these vegetables from the water instead of draining the water off. The dirt and grit will remain in the washing pan or sink. If this water is drained or poured off, the dirt will remain on the vegetables.

Retaining or Restoring Freshness.— After vegetables have been washed clean, keep them in a cool storage place until they are to be prepared.

Wilted vegetables can be refreshed by placing them in ice-cold water to which one-half cup of vinegar per gallon of water has been added. When they are freshened, the vegetables should be covered with a

clean, damp cloth and placed in a cool storage room until you are ready to use them.

Keep the time between preparation and cooking as short as possible. Valuable vitamins are lost when vegetables are soaked too long or are allowed to remain at warm temperatures for several hours.

FROZEN VEGETABLES.— Frozen vegetables have the appearance and very nearly the flavor of fresh vegetables. Like the dehydrated vegetables discussed previously, they are easy to prepare; the precooking tasks have been done. Frozen vegetables have been cleaned and trimmed and are ready to use.

CANNED VEGETABLES.— Vegetables that are canned have been cooked in the container and need only to be brought to the boiling temperature just before they are served. Never boil a canned vegetable; always avoid overheating or overcooking. The liquid from tamed vegetables should be saved and used in soups, sauces, or gravies. Follow the AFRS guidelines for heating canned vegetables.

DRIED VEGETABLES.— A variety of dried vegetables are used in Navy messes. Dried beans and peas are used in soups and entrées (supplemented with meats such as ham, bacon, or ground beef as in chili con carne). Dried garlic is used as seasoning. Dried onions are used extensively in salads and cooking.

DEHYDRATED VEGETABLES.— Dehydrated vegetables are now widely used and popular in Navy messes. Their small weight and volume make them convenient to store. They are easy to prepare. All the precooking tasks associated with raw vegetables have been done for you. They are peeled, diced, sliced, or chopped, and ready to use. They eliminate waste and ensure portion control.

Precooked potato granules, sliced raw potatoes, raw cabbage, chopped onions, and green peppers are some of the dehydrated vegetables used by the Navy. They are reconstituted by adding a measured quantity of the vegetable to a measured volume of water. The temperature of the water will vary (lukewarm or cool) with the specific dehydrated vegetable being reconstituted as will the length of time required for the reconstituting process (15 to 30 minutes). Recipes in the Q (vegetable) section of the AFRS give more detailed instructions for reconstituting dehydrated vegetables.

Cooking Methods

Vegetables may be baked or sautéed they may be simmered or steamed; they may be served with butter or covered with an appropriate sauce; or, after they are simmered or steamed, they may be creamed, mashed, or sautéed.

The basic methods of cooking vegetables are baking, steaming, and simmering.

SIMMERING.— Vegetables are simmered in water with seasonings in steam-jacketed kettles or covered stockpots. Vegetables will lose their fresh appearance, flavor, and nutritive value if they are overcooked.

STEAMING.— Steaming is an excellent method of cooking most fresh vegetables. It is faster than other methods and helps to preserve the fresh appearance and nutritive value of the vegetables. Follow the manufacturer's directions for cooking time and methods for each kind of vegetable. Guidelines for steam cooking are given in the AFRS.

BAKING.— Cook the vegetables in dry heat in an oven with the addition of little or no water. Dry baking is usually limited to potatoes and squash.

OVEN FRYING.— Some vegetables may be parboiled and then placed in a well-greased roasting pan in the oven to complete cooking. Hash browned and home fried potatoes may be oven fried.

DEEP FAT FRYING AND PANFRYING.— Potatoes, onions, and other vegetables such as eggplant, cauliflower, and okra may be french fried. Vegetables that are deep fried and panfried should be tender and cut into uniform size pieces. Panfried vegetables are cooked in a small amount of fat on top of the range. Sautéing is another term for panfrying.

STIR-FRYING.— Carrots, celery, cabbage, sweet peppers, mushrooms, dried and green onions, broccoli, and cauliflower may be stir-fried. Stir-frying is sautéing in hot salad oil or shortening in progressive steps. The cooked vegetables are crisp and crunchy in texture.

PROGRESSIVE VEGETABLE COOKERY.— To make sure a continuous supply of freshly cooked vegetables is available on the serving line, cooking periods must be staggered so that several small batches of vegetables will be cooked one after another. This also helps control waste because a new batch will be started only if it is needed.

Short cooking time is best. Cook only a small quantity of vegetables at a time. Vegetables must be

cooked in the shortest time possible and in a small amount of water. Never use baking soda to preserve color. Overcooking, cooking in too much water, or using soda in the water destroys the nutrients you are trying to conserve.

In fact, undercook rather than overcook vegetables. This is especially applicable when you know the cooked vegetable is to be placed on the steam table or is to have a second heating or cooking period, such as creaming, scalloping, or baking.

To determine if the vegetable is done, press pieces of the vegetable between the thumb and forefinger and taste the sample. If it is done, the vegetable should be tender but have a definite bite quality.

SALADS

Salads have an important place on the menu. They contribute something both nutritious and refreshing to the lunch or dinner meal. Fruit salads and vegetable salads are the most popular. They also introduce valuable vitamins, necessary minerals, and color into the meal.

Salads can be made quickly and easily if a few simple rules are followed. This is equally true for individual salads that often seem more appetizing and receive greater acceptance than a large dish of salad.

After a crisp, refreshing, and attractive salad is produced, it should be served so that none of this attractiveness is lost. Select a cool place for assembling and serving the salad. Bring individual salads from the refrigerator, a few at a time, so that they will remain crisp.

Salad Ingredients

Salads consisting of fruits, vegetables, meat, or a combination of these ingredients provide a good menu for diet-conscious people or people who are trying to lose weight.

Nearly all salads contain some fresh, crisp greens, at least as a garnish; beyond that, however, the range of ingredients is very wide. A salad may consist of greens tossed with dressing, or it may consist of a combination of vegetables or fruits (or both). There are also hearty salads that may be used as the main dish of the meal.

SALAD GREENS.— Select your salad greens carefully. You have a wide choice of greens that are suitable for a salad foundation—lettuce, endive, escarole, young spinach, and cabbage (fig 5-9.) These

may also be used as one of the main ingredients of the salad itself. Parsley and the inner tender leaves of curly endive are good for a garnish.

Sort, trim, wash, and crisp the greens before making the salad. Wash them carefully to free them of sand and earth particles. Drain them well. Hand cut the lettuce and cabbage into strips or pieces. Place the prepared greens in pans, cover them with wax paper or a damp cloth, and refrigerate. They should be drained thoroughly and be free of excess water before they are placed in the serving line. They should be one of the very last parts of the meal to be prepared.

SALAD VEGETABLES.— Fresh, canned, or dehydrated vegetables may be used for salads. Select the fresh vegetables with care. Wash them thoroughly. Trim and peel them, if necessary, and cut them into uniform sizes. Cook those that need cooking. When canned vegetables are to be used in a salad, the liquid drained from the cans should be reserved and used in soups, sauces, or gravies. The canned vegetables may be marinated in French dressing before being used in a salad. Dehydrated cabbage, green peppers, onions, and string beans may be reconstituted and used in salads.

Salads used for the main course for lunch or dinner should be substantial and provide the food values comparable to any other main dish.

SALAD FRUITS.— Fruits add variety as well as color and texture to the salad bar. Fresh, frozen, and canned fruits may be used.

Salad Dressings

The salad dressing is as important as the salad itself. Each type of dressing can take on a new flavor by the addition of different seasonings and herbs.

BASIC DRESSINGS.— The two basic kinds of salad dressings are French dressing and cooked salad dressing. Commercial salad dressing is similar to mayonnaise except that a cooked starch paste is added and less oil is used than in mayonnaise. French dressing is basically oil and vinegar to which many kinds of seasonings may be added. Commercial French dressing usually contains tomato paste or puree as well as emulsifiers that keep the oil and vinegar from separating.

SALAD DRESSING INGREDIENTS.— A variety of seasonings can be added to the oil and acid basic ingredients (usually lemon juice or vinegar) of a salad dressing to produce different kinds of dressings that complement a specific type of salad.



ICEBERG LETTUCE

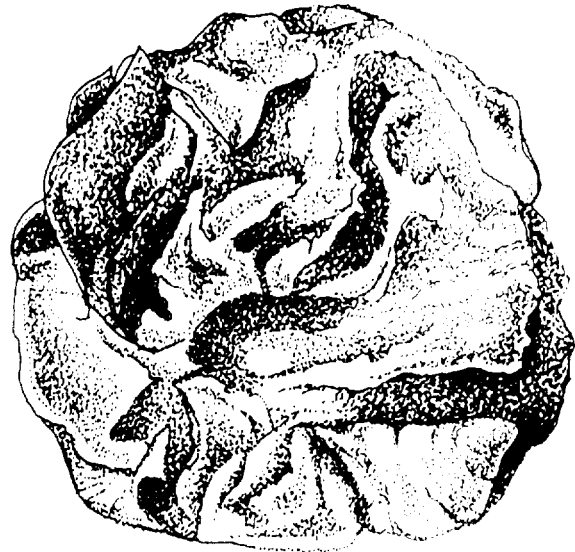

BOSTON LETTUCE



ESCAROLE



ENDIVE



ROMAINE

Figure 5-9.—Salad greens.

Salad Oil.— Salad oil is an important ingredient in salad dressings. It must be fresh. Salad oil can become rancid and have an unpleasant taste if it is exposed to light, air, and heat. Oil will mix temporarily with liquid after being shaken or beaten, but if the mixture is allowed to stand, it will separate again into layers.

Acid.— Fruit juices or vinegar are the acid ingredients in salad dressings. Pineapple or lemon juice can be used instead of vinegar in some recipes.

Seasonings.— Salt, pepper, and sugar are the usual seasonings in salad dressings. Other seasoning such as

mustard, ground red pepper, and herbs add color and flavor.

SALAD DRESSING PREPARATION.— The basic rule in making salad dressings is to make them in advance so that the seasoning will be well blended. Galley-prepared mayonnaise tends to separate if it is not properly made. Some important things to remember are the following:

- Have ingredients at room temperature before mixing
- Combine ingredients exactly as directed in the AFRS
- Make sure the oil is incorporated each time it is added before adding more oil
- Use a bowl that is deep enough to allow the mixture to be well beaten

Mayonnaise should not be stored where it could freeze, nor should it be kept at warm temperatures. The container should be covered and refrigerated when not in use. Mayonnaise will curdle or separate if the oil is added too fast or if the mixture is beaten too little after each addition of oil. If mayonnaise separates, it may be reformed by adding it very gradually to egg yolks (use one egg yolk per gallon of mayonnaise).

NOTE: Only pasteurized frozen eggs are to be used in galley-prepared mayonnaise or salad dressings.

As a rule, salad dressing should be added to a fruit or raw vegetable salad not more than a few minutes before you are ready to serve the salad. If you are preparing salads to be set out on the salad bar, place the various types of salad dressings in separate containers so that each patron may have a choice. Remember to use small-sized containers for the dressings. Any salad dressing that is left over after the meal has been served should be discarded.

RELISHES

Relishes may be used in place of, or with, a salad. The AFRS contains guidelines for relish preparation.

Raw carrots sliced lengthwise, celery, radishes, cauliflower flowerets, green pepper rings, olives, and pickles make excellent relishes and increase the attractiveness of a meal. All raw vegetables, except leafy varieties, should be refrigerated in icy cold water for an hour or more. This should be done before they are served. This process makes the vegetables crisp and tender.

HORS D'OEUVRES

Hors d'oeuvres are appetizers that are nippy, high-flavored mixtures of various foods designed to be eaten from the fingers or from toothpicks. Preparation and service of hors d'oeuvres are customarily associated with private messes.

When hors d'oeuvres are served, they are normally served before formal or informal meals. Hors d'oeuvres are also served at elaborate functions where, as a rule, a meal is not served

Generally, there are two types of hors d'oeuvres: cold and hot. Some examples of cold hors d'oeuvres are ham rolls, fish balls, deviled eggs or shrimp, cheese carrots, or stuffed celery. Hot hors d'oeuvres are usually broiled, baked, or fried in deep fat and served fresh from the broiler, oven, frier, or a chafing dish.

Dips and spreads are sometimes offered with hors d'oeuvres. They can accompany them or be used to complement various crackers or vegetables. Most of the different dips and spreads resemble salad dressings in their composition. Therefore, the same precautions should be followed during preparation, serving, and storing.

SANDWICHES

Sandwiches make satisfying meals and are especially convenient to serve in case of an emergency. This is true under battle feeding conditions when personnel are isolated from regular messing areas, or under similar circumstances. When sandwiches are prepared, remember that they will probably be the primary item of that particular meal and should be substantial. Whenever possible, sandwiches should be served with a beverage, fruit or fruit juice, and raw vegetables that can be eaten from the hand. There is no limit to the interesting and tasty food combinations that can be used for filling sandwiches. Many good recipes are listed in the AFRS.

Sandwich Ingredients

All sandwiches will have a bread of some sort. In addition to the bread, a sandwich will include one or more of the following: a sandwich filling such as egg salad; sliced cold meats; or a spread such as deviled ham; and individual condiments such as catsup.

BREADS AND ROLLS.— Sandwiches may be made with any kind of bread. Varying the bread helps to avoid monotony. The kind of bread used should be

appropriate for the type and flavor of the filling to be used. There is no set rule for such combinations as the choice is determined by individual taste. Sandwiches may be served hot or cold.

Breads that are used most often include white, rye, pumpernickel, and whole wheat as well as various types of rolls and buns.

When you are making sandwiches, use slightly firm bread. Day-old bread is preferable because it is more easily handled than freshly baked bread. Bread requires special handling to prevent it from becoming stale. To prevent moisture loss or absorption, observe the tips listed next on wrapping and storing bread and rolls:

- Store bread in a moistureproof wrapper.
- Store bread at moderate temperatures (75°F to 85°F) in a clean, dry space away from food.
- Maintain a clean, dry storage place for the bread and rolls. Separate from other stores to prevent absorption of odors and flavors.
- Bread should not be stored in chill spaces because it will stale rapidly. However, freshly baked and cooled bread and rolls may be wrapped in moistureproof material and frozen for later use.

SANDWICH FILLINGS.— The choice of fillings should be determined either by when the corresponding sandwiches will be eaten or by how the filling is used. For example, they may be served in sandwich meals (box lunches), as appetizers, or as a food item on a regular menu or fast-food serving line.

Some of the types of fillings are salad mixtures such as tuna, egg, and ham. Such mixtures as ground meat, chopped egg, fish or shellfish, or any filling containing mayonnaise or salad dressing should never be made for sandwich meals. These foods are likely to be contaminated with bacteria that will grow rapidly at room temperature and can cause illness.

Cold cuts and peanut butter and jelly are suitable fillings for sandwiches to be served either in or away (such as box meals) from the GM.

Sliced Cold Meat.— Cold sliced turkey, chicken, roast beef, bologna, salami, ham, or cheese are considered cold cuts.

When used as fillings, these meats should be cooked according to AFRS recipes. After being cooked, the meat should be covered and refrigerated without slicing until just before the sandwiches are to be prepared. If the meat is sliced ahead of time, it will dry out even if it

is covered and refrigerated. When you are ready to prepare sandwiches, slice the meat thinly and remove gristle and excess fat. Thinly sliced sandwich meats are more tender and juicy than thickly sliced meats. Slice only enough for immediate use.

Spreads and Individual Condiments.— To avoid risk of contaminations and to allow the user an individual choice, such spreads as salad dressing, mayonnaise, mustard, or catsup should be packed separately. Always follow the AFRS directions for making sandwiches.

Sandwich Variations

The description and preparation methods for some of the sandwich variations are as follows.

CLUB SANDWICHES.— Club sandwiches are made with three or more slices of toasted bread and two different fillings, one in each layer. Each sandwich is cut into quarters to form triangles. Toothpicks may be used, if necessary, to hold layers together.

GRILLED OR TOASTED SANDWICHES.— In grilled or toasted sandwiches the filling is often cheese placed between two slices of bread. The top and bottom of the sandwich is spread with melted butter or margarine, and the sandwich is grilled on both sides. Also, these sandwiches may be lightly brushed with melted butter, placed in sheet pans, and toasted in the oven.

OPEN-FACED SANDWICHES.— Open-faced sandwiches may be either one or two slices of bread covered with any desired filling including slices of meat, cheese, or tomatoes. When two slices of bread are used, they are placed side by side rather than one on top of the other.

SUBMARINE SANDWICHES.— Submarine sandwiches (hero, hoagie, grinder, or poor boy) are prepared from French bread or a hard roll cut in half lengthwise. Each half is spread with salad dressing. Layers of thinly sliced salami, bologna, cheese, ham, tomatoes, and lettuce are then arranged on the bottom half. The sandwich is covered with the top half and cut vertically into portions. If these sandwiches are used for box meals or bag lunches, the salad dressing, tomatoes, and lettuce should be portioned and wrapped separately.

SLOPPY JOES.— Sloppy Joes are sandwiches made with barbecued ground beef spread between halves of toasted sandwich buns.

HOT SANDWICHES.— Hot sandwiches are usually served open-faced with sliced meat and gravy.

However, they are often served with a soup, a potato, and vegetables. They are good main dishes for lunch or dinner when served this way.

FINGER SANDWICHES.— Finger sandwiches are two slices of bread with a filling such as tuna, egg, or ham salad cut into three rectangular strips. Finger sandwiches are normally served as appetizers or for ceremonial occasions. Because these sandwiches contain salad mixtures, they should not be used in box lunches.

Sandwich Production

To make many sandwiches quickly, follow the steps shown in figure 5-10. Have all sandwich material ready,

allow ample work space. Sanitary procedures and precautions must be strictly followed in the preparation and serving of sandwiches. Some of these procedures and precautions are listed next.

- Fillings for cold sandwiches are highly susceptible to bacterial contamination, and every precaution should be taken when preparing and serving sandwiches. Never allow sandwiches to stand at room temperature for more than 4 cumulative hours. This 4-hour period includes the time spent chopping or dicing food after it has been cooked. If the sandwiches will not be consumed immediately, they must be held at temperatures below 40°F.

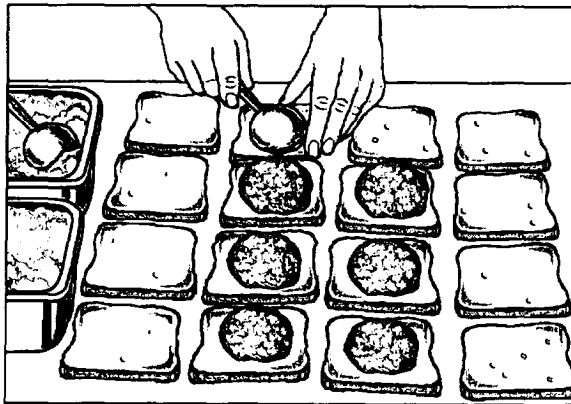

STEP 1: Use a scoop to place salad fillings on two center rows of bread.

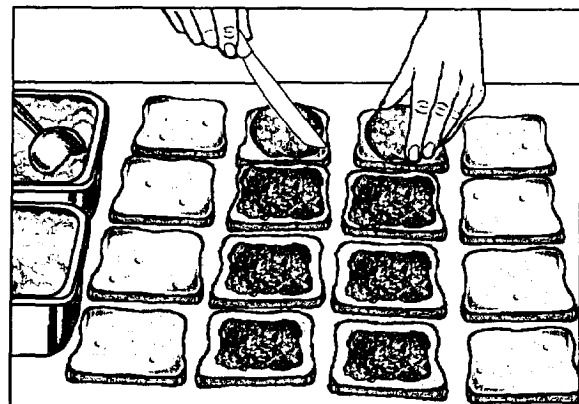

STEP 2: Spread fillings to edge of bread, using two strokes. Place matching slices of bread on top of filling. Use both hands.

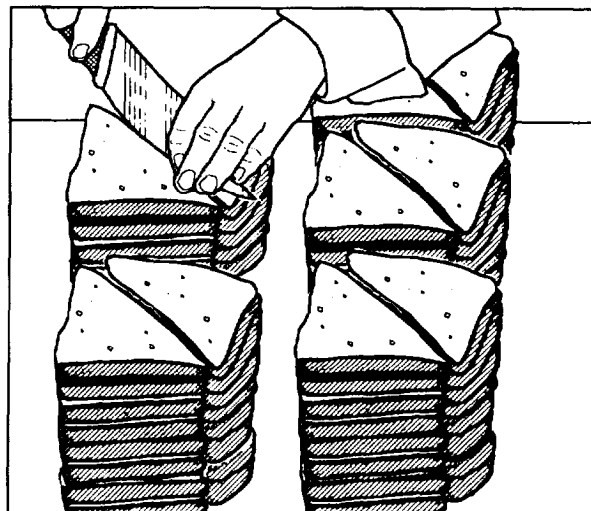

STEP 3: Stack sandwiches and cut in half diagonally.

Figure 5-10.—Steps in producing sandwiches with salad fillings.

When you are refrigerating fillings, they should be placed in shallow pans so that the contents will be quickly and completely chilled. Whenever possible, sandwiches should be made to order.

Sandwiches intended to be eaten hot, such as a reuben or hot roast beef, must be prepared upon customer request or immediately before serving in a feeding operation such as a GM.

- Never place or prepare sandwiches on a cutting board or surface that has been used to prepare raw chicken or turkey.

- Keep sandwich counter and equipment thoroughly clean and sanitized.

- Clean chill boxes and accessories frequently to avoid mold and undesirable odors.

- Use sanitized utensils instead of hands whenever possible.

- Requisition and prepare food in the quantities needed so that there will be a rapid turnover and as few leftovers as possible.

- Keep the time between preparation and consumption to a minimum.

- Pack or serve lettuce, tomatoes, and spreads used in bag or box lunches separately.

- Keep the filled sandwiches at a temperature of 40°F or lower if possible.

- Avoid leftovers. Do not use any foods for sandwich fillings, including leftover meat and eggs, that have been held at 40°F or over for more than 30 minutes. Bacteria grow more rapidly in some foods than in others.

- Immediately following the preparation, wrap each sandwich separately and refrigerate. Never use a dampened cloth or towel to keep bread or sandwiches moist.

- Avoid stacking a large number of sandwiches or placing sandwiches in cardboard boxes. This method actually insulates the food and prevents it from cooling as fast as it should to the desired storage temperature.

- When sandwich meals are prepared for box lunches, the boxes should be marked in the following manner to make sure customers know the safe time limit within which the meals should be eaten:

Date and time issued: _____

Keep under refrigeration or eat by:

(within 4 hours after time of issue)

Prepared by: _____

(initials/time/date)

Box Lunch Assembly

For efficient assembly of box lunches, devise a checklist of all items to be included and post where it is plainly visible to those responsible for filling the orders. Be sure to list items to be served with the meals, such as salt and pepper, cream substitute and sugar, and other appropriate condiments and spreads.

Because choices of food items for box meals are limited, menu planners may find it difficult to include a wide variety of food. The AFRS has many recipes for sandwiches, breads and rolls, desserts, and relishes that will help give variety to menus.

Selections from the following food items are suggested for inclusion in breakfast, lunch, or dinner box or bag meals:

- a. Fruit
- b. Juice
- c. Cereal, ready-to-eat, instant or cold
- d. Breads, pastries, rolls, butter, or jam
- e. Eggs (especially hard-boiled)
- f. Soup
- g. Cheese
- h. Meat
- i. Relishes (raw vegetables, pickles, or olives)
- j. Condiments and salad dressings
- k. Accompaniments (cranberry sauce or applesauce)
- l. Desserts (pudding, yogurt, or bakery items)
- m. Milk
- n. Beverages (cold or hot)
- o. Raisins, nuts, or granola-type bars

Suggested menu patterns for box meal menus can be found in NAVSUP P-421.

Soups

Soup is a tasty, popular food. It is nutritious, wholesome, and stimulates the appetite. Soup should be served at least once a day in cold weather, if practical, and at least every few days regardless of the weather. A key rule in serving soup is that it be served as hot as possible.

GALLEY-PREPARED SOUPS.— There are four basic kinds of soup:

1. Light soups are made from clear, unthickened stock.
2. Heavy soups are made from stock vegetables, rice, or pasta such as noodles, macaroni, and spaghetti.
3. Cream soups are made with milk, stock, or vegetables and lightly thickened. They should be heated to serving temperature, but never allowed to boil.
4. Chowders are made with fish, shellfish, or vegetables.

There are three basic soup ingredients: stock vegetables, and thickeners. These basic ingredients are discussed next.

Stock.— Stock is made by cooking meat bones, poultry bones and trimmings, vegetables, and seasonings in water. Alternately, it is made by using dehydrated soup and gravy bases, which saves time, labor, and space. These various bases contain salt; therefore, the amount of salt added should be determined by careful tasting during the cooking process.

The standard stock items, instant beef, chicken, or ham soup and gravy base, may be reconstituted for use in any soup recipe. These powdered bases are seasoned and when they are reconstituted in boiling water they have the characteristic flavor of beef, ham, or chicken broth. The proportions that should be used to reconstitute these bases are included in the A (miscellaneous) section of the AFRS.

Vegetables.— The vegetables most commonly used for soups are celery, carrots, peas, beans, onions, green peppers, and tomatoes. Vegetables are cut into small cubes, or into matchlike strips that are called julienne. Vegetables used in soups should be cooked according to the instructions given in the AFRS for soup.

Thickeners.— Soups are thickened by adding a roux or a paste. A roux is a mixture of fat and flour. A

cold, light roux is usually added to soups that are to be thickened. In onion soup, for example, the cold roux is stirred into the hot soup stock and the soup is cooked until no taste of raw starch remains. Roux may be prepared ahead of time and refrigerated. A roux may be prepared by two methods: the cold roux method or the warm roux method. Cold roux is prepared by combining flour with liquid fat, then stirring until a smooth paste is formed. In the warm roux method the fat is first melted over low heat and then the flour is added.

A paste is prepared by whipping flour or cornstarch into a cold liquid (usually water) and then adding it to hot liquid that is cooked until it thickens. In the final step of preparing bean soup, for example, a flour and water paste is stirred into the soup that is then cooked for 10 minutes.

GALLEY PREPARED SOUPS.— The individual recipe in the soup section of the AFRS specifies the types and amounts of seasonings that should be used. When meat or chicken stock is made, the flavor from the ingredients used is very concentrated; therefore, it is essential to use accurate amounts of the ingredients. Just before the soup is to be served, check it again for proper seasoning. It is better to add more seasoning to the stock or soup a short time before it is served, rather than have a soup so highly seasoned it is unpalatable. If the taste check indicates that the soup is too salty, add sliced raw potatoes to the soup, bring soup to a simmer for a few minutes, then remove the potatoes.

COMMERCIALY PREPARED SOUPS.— Dehydrated, instant, condensed, and ready-to-serve soups are not only easy to prepare but they are also time- and space-savers.

Dehydrated soups such as chicken noodle, green pea, and tomato vegetable are prepared by merely adding the specified amount of boiling water. Then the mixture is covered and allowed to simmer for the length of time specified on the container. The finished product is similar in appearance and flavor to the same type of soup made with raw food items.

Sauces

Sauces add to the appearance and flavor of food, but they should never be overpowering. Sauces should be handled carefully to avoid contamination and food-borne illness. Store in a chill space and never hold them longer than 4 cumulative hours at temperatures between 40°F and 140°F.

CREAM OR WHITE SAUCE.— Cream or white sauces are made with butter or margarine, flour, and milk and have many variations. These sauces must be cooked over low heat. They require constant stirring to avoid scorching. The sauce is cooked until it coats the back of the spoon.

Thin and medium white sauces are used to bind ingredients together in scalloped meat, fish, egg, and vegetable dishes. Medium white sauce may also be served over food.

BUTTER SAUCES.— A white sauce with a high percentage of butter and little or no seasoning other than salt is considered a butter sauce. This sauce is used principally with green vegetables, such as asparagus and broccoli, and with fish and shellfish.

OTHER SAUCES.— Sauces served with meat, chicken, seafood, omelets, and spaghetti are prepared according to recipes in the AFRS. Also, commercially prepared sauce mixes are available. These include basic tomato, sweet and sour, cheese, barbecue, taco, and enchilada sauces. Directions for use are found on the containers. Some examples of sauces and their uses are as follows:

Sweet, thickened:

Raisin	Baked ham
Pineapple	Baked ham

Unsweetened, thickened:

Hot mustard	Ham
Tomato	Veal steaks
	Stuffed green peppers

Uncooked, unthickened:

Tartar	Seafood
Seafood cocktail	Seafood

Cooked, unthickened:

Barbecue	Beef, pork
Spaghetti	Spaghetti

Gravies

Any gravy served should go with the food it is intended to compliment. The O section of the AFRS contains many recipes to be served with meat and poultry. Thickened gravies are made by adding flour to the pan drippings left after roasting and browning meats. This flour mixture forms a roux that is then added to stock. The gravy is stirred and simmered until the mixture thickens. There are numerous

types of gravies. A good gravy should be as smooth as cream.

CREAM GRAVY.— Cream gravies are made by adding milk to the roux instead of stock or water. Cream gravy is usually served with chicken or ham.

NATURAL PAN GRAVY.— Natural pan gravy (au jus) is unthickened gravy that is usually served with roast beef. Water or stock is added to the meat drippings and the gravy is allowed to simmer until hot.

BROWN GRAVY.— Brown gravy is prepared by cooking the flour and fat mixture (roux) until it is brown. Brown gravy is the basic gravy used to make giblet, mushroom, onion, and vegetable gravies. Brown gravy mix is a dry mix that requires only the addition of hot water.

Gravy Preparation

Thickeners, liquids, fats, and seasonings are combined to form gravies. Certain tips will assist you in preparing and serving gravies.

THICKENERS.— To make smooth gravy, a roux must be used for thickening. Flour or other starch will form lumps if added directly to hot liquid. To make brown gravy, the flour and fat mixture (roux) is cooked until it is a rich, brown color. The roux is added to the hot stock and the mixture is simmered until it is thickened. To make cream gravy, the roux is cooked, but not browned. The roux is added to milk or light stock and cooked until thickened and no taste of the starch remains.

LIQUIDS.— If a large amount of gravy is prepared, there should be enough stock to ensure a good flavored gravy. Tomato juice or the liquid saved from mild-flavored cooked or canned vegetables (beans, peas, carrots) can be substituted for part of the water. Reconstituted soup and gravy base can be substituted for all or part of the stock. Since salt is an ingredient in these bases, no additional salt is added until cooking is completed. The gravy should then be tasted and salt added only if necessary.

FATS.— Fat from the pan drippings provides flavor. If there is not enough fat remaining in the pan from the meat to make a sufficient quantity of gravy, melted shortening can be added.

SEASONINGS.— Seasoning the gravy is important. Avoid overseasoning. Add salt and pepper in moderate amounts and taste the gravy during preparation to see if more is needed.

PREPARATION AND SERVICE TIPS.— If lumps should occur when you are making gravy, strain the gravy or whip vigorously with a wire whip. If gravy is not to be served immediately, cover the pan and keep it hot; or it may be refrigerated and reheated when ready to use. Gravy should be handled carefully to avoid contamination and food-borne illness. Store it in a chill space and never hold gravy longer than 4 cumulative hours at temperatures between 40°F and 140°F.

Dressings

Dressings are usually served as the starch addition of a lunch or dinner meal when the entrée consists of a poultry product such as turkey.

The terms *dressing* and *stuffing* are often used interchangeably, but they both actually refer to dressing. If the dressing is cooked inside the poultry, it is referred to as stuffing.

Excellent dressings can be prepared that are not cooked inside the birds. Pan-baked dressing requires more moisture and is less firm than stuffing, but is easier to prepare and easier to serve. Good dressing is light and moist, not heavy and pasty.

Poultry stuffed with dressing is not recommended for large-scale food operations such as GMs because it increases cooking time, imposes a larger workload on foodservice personnel, and it does not improve or enhance the flavor of the meat. Most importantly, stuffing poultry is a sanitation risk and increases the possibility of food-borne illness.

The AFRS includes the basic bread dressing recipe and its many variations that may be served with either chicken or turkey.

CEREALS, PASTA, AND RICE

Cereals, pasta, and rice are all grain products that are used as the starch portion of a meal.

Cereals

Cereals are foods made from grains of wheat, oats, corn, rice, rye, and barley. Cereals are often referred to as breakfast foods, but are not limited to the breakfast meal. Cereals can be used in many types of recipes. The types include instant, quick-cooking, and cold ready-to-eat cereals.

Instant cereals do not require further cooking. They are simply mixed with boiling water before serving.

Quick-cooking cereals require a shorter cooking time than regular cereals. To prevent quick-cooking cereals from forming lumps, they should be stirred slowly into rapidly boiling water. Quick-cooking farina is mixed with cold water and then added to boiling water. These cereals should be stirred constantly until they boil. After they begin to boil, reduce to a simmer and stir them occasionally. Overstirring and overcooking will cause cereal to be sticky and gummy.

Ready-to-eat cold cereals require no cooking and are served with cold milk and sugar. No added sugar is needed for the coated or frosted cereals. For variety, sliced peaches, strawberries, prunes, or bananas maybe added.

Pastas

Pastas (macaroni, spaghetti, vermicelli, and noodles) are produced from semolina durum wheat flour, farina, or hard wheat flour (other than durum wheat flour) and water. Egg noodles also contain eggs. The mixtures are rolled, shaped, and dried in various forms. The only difference between vermicelli and spaghetti is that the individual strands of vermicelli are finer and require less cooking. They may be used interchangeably in recipes specifying spaghetti or vermicelli.

Pastas should be added to vigorously boiling, salted water and stirred so that they will not stick together or to the bottom of the kettle. A small amount of salad oil is added to the water to help to prevent sticking. Pastas should be drained as soon as they have finished cooking. If pastas are overcooked, they become soft and gummy.

Rice and Barley

The rice products used in the military feeding programs are parboiled, long-grain, and medium-grain rice. They need not be washed before cooking. Cooked long-grain rice should appear light textured and the individual grains should stand apart. Medium-grain rice, when cooked, will clump together. This type of rice is preferred in Oriental dishes. Directions for proper cooking by steaming, simmering, and baking are contained in the AFRS. Rice may be served plain, as a potato substitute, combined with other ingredients in a main dish, added to salads, or topped with highly seasoned sauce. For variety, combine rice with herbs, spices, chopped onions, or nuts. Rice pudding can be served for dessert.

Barley is a grain used principally as a soup ingredient.

Popcorn

Popcorn is a snack food that usually is served during periods of relaxation such as watching movies or playing board or card games.

Popping popcorn is simple. You will either use a popcorn popper or use a large pot. For either method, just follow the instructions provided by the manufacturer. Salt and butter or margarine should be provided separately when serving popcorn to comply with today's fat and cholesterol health standards.

BEVERAGES

Beverages are an important part of Navy meals. The preparation of high-quality beverages requires the skill, technique, and experience of an accomplished MS. The types of hot and cold beverages used in the GM include milk, coffee, tea, cocoa, fruit and vegetables juices, fruit-flavored drinks, and soft drinks. Good quality drinking water also should be available.

Milk

Milk is one of the most important and most frequently used foods, as well as popular beverage. It is important to keep in mind that milk, served as a beverage or used in cooking, is a potentially hazardous food. To ensure safe, high-quality milk, follow these practices:

- Know the characteristics and recommended use of each type of milk. (See chapter 4 of NAVSUP P-421.)
- Select the proper types of milk to meet your foodservice operation's requirements and storage capacities.
- Handle milk according to safe, sanitary procedures.

For more information on milk, consult the NAVSUP P-486, volume I, and the *Manual of Naval Preventive Medicine*, chapter 1.

Coffee

The preparation of coffee demands as much detailed attention as does any other part of the meal. Tastes for coffee vary widely. Some people prefer a weak brew while others enjoy a strong one. The AFRS contains directions for brewing various strengths. Good coffee will smell fragrant and mellow. The color will be a deep

brown but not black. The taste will not be rancid, oily, or bitter. The strength of the coffee depends on the proportion of water used in relation to coffee grounds. A milder brew results from using either more water or less coffee than normally. Bitterness results from brewing the coffee too long.

Several suggestions that will help you produce brewed coffee of consistent quality follow:

- Store roasted coffee in an airtight metal container because coffee loses its flavor and aroma rapidly when exposed to air. Also, it will also absorb odors that lower its taste quality.
- Use older stocks first. Within 3 days after opening, vacuum coffee has lost much of its flavor.
- Always measure both the coffee and the water.
- Use fresh coffee at all times, and keep the coffee covered while it is brewing.
- Never allow coffee to remain in contact with boiling water as the flavor and aroma will boil off.
- Remove the grounds as soon as the coffee is made. Seepage from the grounds will ruin the flavor of the best coffee.
- Brewed coffee should not be held for more than 1 hour as it deteriorates in flavor and loses its aroma.
- Most important of all, keep the coffee-making equipment absolutely clean. Wash the urn with clear, hot water immediately after you have used it, and at the end of the day clean it with hot water and urn cleaner. Rinse thoroughly with clear water. Never use soap or soap powder

Tea

Normally, two forms of tea are used; bulk tea and tea bags. Instant, powdered tea however, also has special uses in the military services.

The quality of brewed tea depends upon how fast the boiling water extracts flavor and color from the tea leaves; it is the tannin present in the leaves that gives the tea a bitter taste. Improper temperatures, brewing too long, and holding tea too long for service will bring out the bitterness of the extracted tannin.

The proper quantities of both water and tea should be measured carefully. Never guess at the amounts,

HOT TEA.— You will not have any trouble making excellent tea if you follow a few simple rules:

- When loose tea (not enclosed in a cloth bag) is placed in the urn or kettle, the tea should be strained after it has steeped for 5 minutes.
- Tea should be made just before serving.
- Do not boil; this brings out the bitter taste.
- Schedule preparation so that not more than 15 minutes will elapse between its preparation and service; hold prepared tea at 175°F to 185°F.

ICED TEA.— The following points should be observed when preparing tea to be served iced:

- A stronger brew is required for iced tea than for hot tea because of the diluting action of the ice,
- A tea concentrate may be brewed and chilled, then diluted before serving.

- Do not add cold water to the concentrate; this may produce cloudy tea. The concentrate should be poured into the cold water.
- The tea may be presweetened by dissolving sugar in the hot concentrate before diluting it with cold water.
- If desired, cut lemons into eighths to serve with tea

Other Drinks

The C (beverage) section of the AFRS contains many recipes for various fruit drinks and milk drinks that may be prepared and served with either lunch or dinner. When you prepare fruit drinks such as lemonade or grapeade, it is important to remember to make the drink early enough to allow time for thorough chilling in the refrigerator. If ice is used to chill the beverage, adjust the amount of water used.

CHAPTER 6

MEAT, POULTRY, AND SEAFOOD

Meat, poultry, and seafood offer excellent nutritional benefits. Importantly, a large share of basic daily food allowance (BDFFA), or the monetary value required to provide a nutritionally adequate diet for one person for 1 day, is spent on meat, poultry, and seafood.

This chapter explains the following topics:

- Types of meat procured by the military
- Grades of beef, pork, veal, lamb, poultry, and seafood used by the military
- Styles of poultry used by the military
- Meat thawing methods
- Meat cooking methods
- Poultry cooking methods
- Seafood cooking methods

MEAT

Meat is the flesh of any animal used for food. The word *meat* as used in the Navy foodservice means beef, veal, pork, lamb, or rabbit. Meat appears on the Navy menu in some form each day. It is the focal point of every meal, dictating what other dishes will be served. Correctly cooked and served meat is the sign of a well-informed and skillful MS.

FORMS OF MEAT

The forms of meat procured by the military are frozen, fabricated, and canned.

Fabricated meats have been either partially or completely boned, trimmed, and portion-cut into slices, steaks, chops, or roasts. Most types of meat procured by Navy messes are fabricated to some extent.

A completely fabricated meat has all bones removed and is cut into portion-sized steaks or roasts. For example, boneless beef is cut from selected wholesale beef cuts or carcass meat according to specifications of the armed forces. The meat is wrapped, packed in shipping containers, and then frozen. Bones, excess fat, gristle, and tendons are removed by the processor.

BEEF

Beef comes from cattle and is the most frequently used of all meats. There are five categories of beef.

- Steer: male that is castrated when young
- Cow: female that has calved
- Bull: fully developed male
- Heifer: young female that has not born a calf
- Stag: male castrated after maturity

Steers and heifers are most suitable for use in Navy messes; whereas cows, bulls, and stags are older and stringier and may be found in canned products.

A beef chart (fig. 6-1) shows the location and uses of various cuts of beef procured by the military for use in the general mess (GM).

Beef Inspection

All beef and beef products prepared in establishments operating under Federal Meat Inspection Regulations are branded or labeled as follows: "U.S. inspected and passed by Department of Agriculture"; "U.S. inspected and passed"; U.S. INSP'D & P'SD"; together with the number that identifies the establishment. These stamps (fig. 6-2) indicate that the beef and beef products bearing these stamps comply with the inspection regulations of the United States Department of Agriculture (USDA), and that they are wholesome and have been processed under sanitary conditions.

Beef delivered under contract to the military within the continental United States is not accepted unless each item (or the shipping case) bears the inspection stamp or USDA label. Each item must also bear a Department of Defense stamp that indicates that the item meets all terms of the contract (fig. 6-3).

After it is determined that the animals are free of disease and meet sanitary requirements, the USDA stamps are placed on the meat carcass.

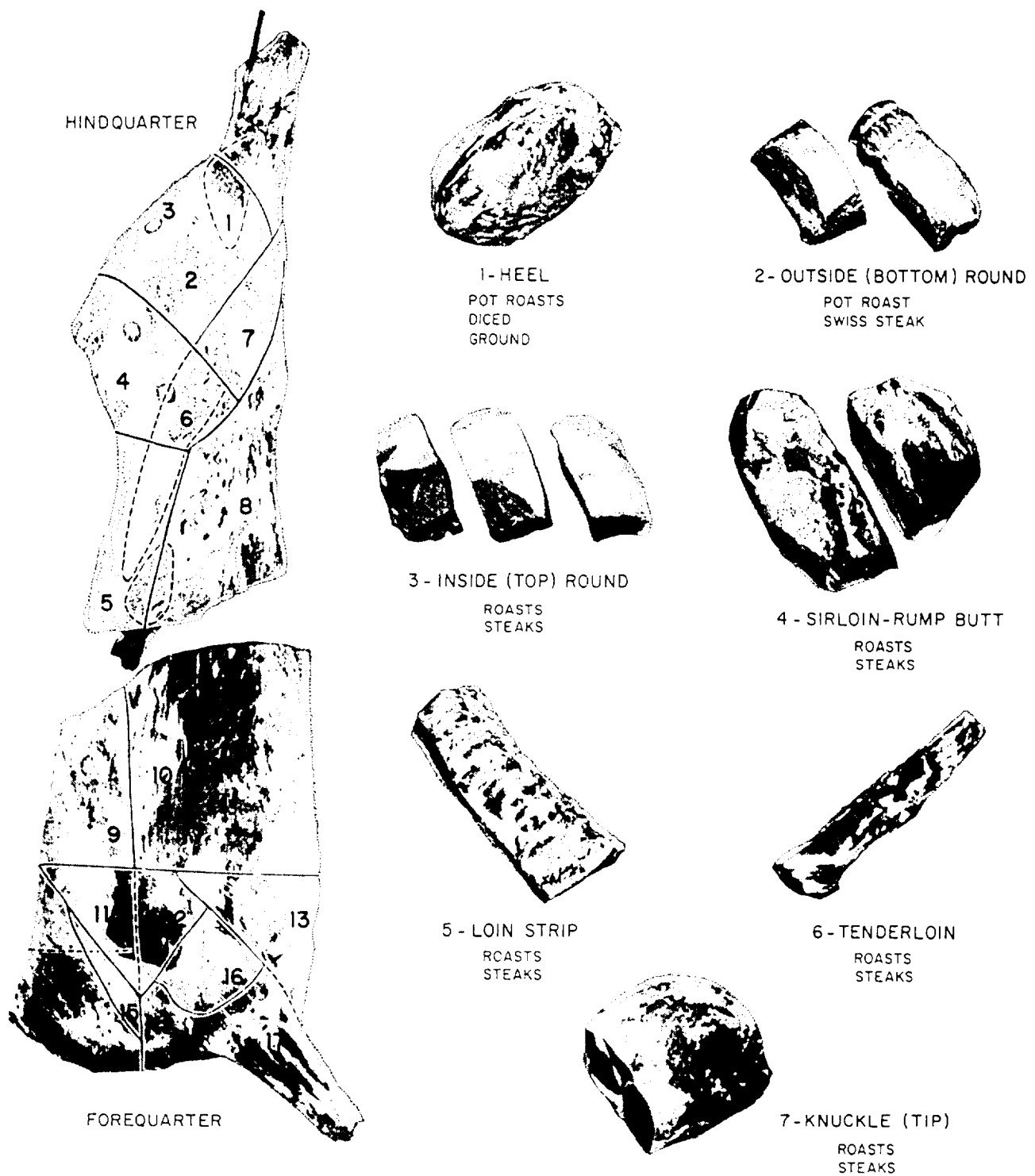

Figure 6-1.—Cuts in a side of beef.

Grades of Beef

Beef is graded as prime, choice, good, standard, commercial, utility, and cutter. The military services generally purchase only choice and good grades.

However, utility grade or better ground beef and beef tenderloins are procured ungraded.

Beef roasts and steaks procured for the Navy are choice grade. Choice grade meats are tender, juicy, and flavorful. Some beef items such as

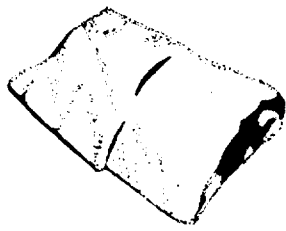

9- BONELESS RIB
ROASTS
STEAKS



10- BONELESS PLATE
BRAISE
STEW
GROUND



13- BONELESS BRISKET
BRAISE
STEW
GROUND



11-INSIDE CHUCK
POT ROASTS
SWISS STEAKS



12- UPPER HALF- CLOD
POT ROASTS



16- LOWER HALF- CLOD
POT ROASTS



15- CHUCK TENDER
POT ROASTS



14- BONELESS NECK
BRAISE
STEW
GROUND

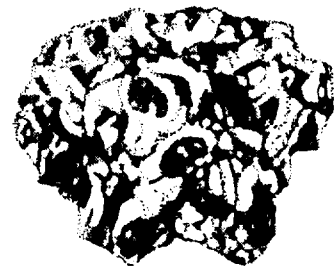

8, 10, 13, 14, 17-
BONELESS STEW

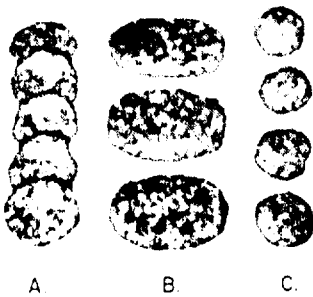

A. BEEFBURGERS
B. SALISBURY STEAKS
C. MEATBALLS

Figure 6-1.—Cuts in a side of beef—Continued.

diced beef may be from choice or good grade meat. Good grade beef is not quite as tender, juicy, or flavorful as choice grade, but if the proper preparation methods are used, an acceptable product is produced.

Good grade beef has less fat marbling than choice or prime grade beef.

Frozen boneless beef products that are procured include the following:



Figure 6-2.—Department of Agriculture Inspection stamps.

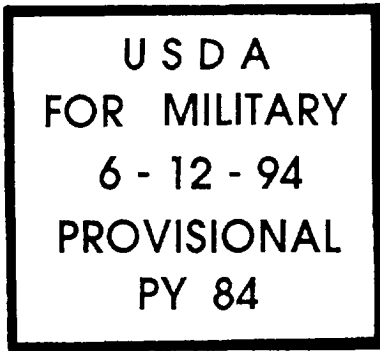
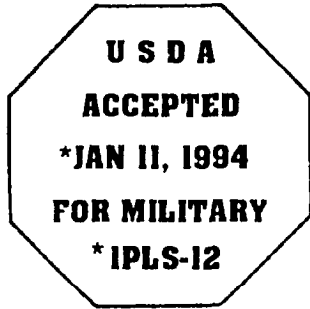

THIS STAMP IS USED BY RESIDENT POULTRY, SHELL EGG, AND EGG PRODUCTS GRADERS.

THE LETTERS "PY" IDENTIFY THE DIVISION AS POULTRY. THE NUMBER FOLLOWING IDENTIFIES THE GRADER PERFORMING THE INSPECTION.

Figure 6-3.—Inspection stamps of Department of Agriculture and Department of Defense.

- Grill steak..... Average weight: 7 ounces.
Rib-eye, loin strip, sirloin butt.
- Sandwich steak.....Wafer-thin slices of lean beef, 2 ounces.
- Swiss steak, braising.....Average weight: 6 ounces.
- Oven roast.....Approximately 10 pounds.
Knuckle, top round.

- Oven roast, precooked.....Top round. Product is ready to be sliced and served. May be heated on grill or served with hot au jus.
- Pot roast.....Maximum weight: 10 pounds.
Shoulder clod or chuck roll.
- Beef pattie mix, bulk..... Packaged in rectangular or chub with 20 percent soy pack units. Approximately 7-pound package.
- Beef patties with 20 percent soy.....Weight. approximately 3 ounces.
- Beef for stewing, diced..... Prepared from selected bone-in or boneless whole beef cuts.
- Rib-eye roll.....Weight. 8 to 10 pounds.
- Rounds.....Prepared from bone-in rounds.
Weight 35 to 57 pounds.
- Tenderloin.....Minimum weight: 4 pounds.
Ready to roast or slice into steaks.

Each box of boneless beef is clearly marked to show the type of meat inside.

Bone-in beef (beef rounds and ribs) should be used only as storage space permits. It requires more storage space than boneless beef. The beef rounds have the rump and shank removed. The weight range for rounds is 40 to 64 pounds. The oven-ready weight range of beef ribs is 14 to 22 pounds.

PORK

Pork comes from hogs. Pork is USDA inspected and graded, but grade marks are not indicated on the meat for consumer use. The difference in the tenderness, juiciness, and flavor of the different grades of pork is not as great as it is in the different grades of beef. The flesh of hogs is the lightest in color of all meats. Young pork is white to grayish pink; pork from older animals is darker pink. The flesh should be firm

and fine grained and should have a good intermingling of fat and lean.

The Navy procures both fresh and cured pork. The fresh cuts, which may be delivered frozen, are pork butts (Boston), boneless pork hams, bladeless pork loins, boneless pork loins, pork hocks, pork sausage, diced pork, pork spareribs, country-style ribs, and pork tenderloins. Cured products include Canadian-style bacon, raw and precooked bacon, boneless cooked smoked ham, smoked pork hocks, and canned ham (pear-shaped, pullman-shaped, and chunks).

As with beef, pork should be handled, cut, prepared, and packaged according to contract specifications. The curing processes are applied to the basic pork products such as ham, shoulder (picnics), and bacon.

The bladeless loin is that portion of the loin that remains after the blade bone and related cartilages and the overlying flesh have been removed. The boned pork loin is the regular cut loin that has been trimmed and boned, cut in half, and the two halves placed together and tied to form a symmetrical roast. If desired, pork chops may be cut from the boneless pork loin.

Boneless slices consist of 5 ounces of boneless loin. Pork tenderloin is a muscle that has been removed from the loin section of pork sides. Spareribs are the bony but flavorful rib section. Country-style ribs are prepared from the backbone. Frozen pork sausage is available in links, bulk and pattie styles. All pork sausage products are very perishable and have a short shelf life of 2 to 3 months. Fresh pork hocks and pigs' feet are available for use. Pigs' feet may be served with cooked greens or as an entrée. Fresh pork hocks are uncured and generally served with sauerkraut.

Bacon is served more frequently than any other pork product. Frozen raw or canned and frozen precooked items are available. Precooked frozen and canned bacon require only heating to a serving temperature. They save space and reduce waste. Although initially more expensive, each pound of precooked bacon is equivalent to 2 1/2 pounds of raw bacon.

Smoked pork hocks may be cooked and served as a main course or used to season cooked greens.

Hams procured by the Navy may be fresh, frozen, canned, smoked boneless, or whole hams. All hams are skinned. Fresh pork hams are frozen and also boneless. They range in weight from 8 to 14 pounds. Canned hams are pasteurized and may be used without further heating, but heating and glazing improve the flavor.

They should be stored and kept under refrigeration at all times.

Canned hams have a high yield, are easy to prepare, and are economical if they are sliced properly. Improperly sliced ham will not only produce uneven portions that are unattractive but will produce more waste and will increase the overall cost. The following slicing technique is recommended to obtain the maximum number of usable slices from either whole or tamed ham after it is baked or as it comes from the can.

1. Divide the whole ham into three sections. Cut the upper third section straight across the butt end and cut the remaining portion into two even pieces lengthwise.
2. Cut the slices lengthwise with the grain, across the butt section. Cut the other sections across the grain as shown in figure 6-4.

VEAL

Veal/calf is immature beef or calves less than 1 year old. Good veal/calf has a light grayish pink color and has a firm, smooth appearance. The types of veal/calf procured are boneless roasts (5 1/2 to 7 pounds), ground veal, and breaded veal steaks. Breaded veal steaks, 5 to 6 ounces, are produced from veal using a flake-cut method. The product is ready to cook. Deepfat fry, add cheese and tomato sauce, and heat until hot in ovens. Veal steaks should be cooked frozen to ensure a moist, tender product.

LAMB

Official USDA grades for lamb are prime, choice, good, utility, and cull. These grades are based on conformation (shape of the cut) and quality. The military services procure only prime and choice.

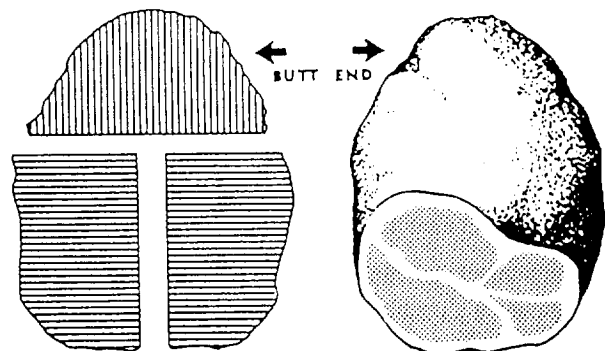

Figure 6-4.—Slicing boneless ham.

High-quality lamb has a smooth covering of clear, white, brittle fat over most of the exterior. The lean portion is pinkish red in color, fine in texture, and velvety in appearance. GMs use only boneless leg roast.

RABBIT

Like other lean meats such as poultry and fish, rabbit is also a good source of high-quality protein. The military procures ready-to-cook, cutup frozen rabbit. The usual method of preparation is frying.

OTHER MEAT ITEMS

Other meat items that are used in the GM are as follows:

- Beef liver is available in portion-cut 4-ounce slices.

- Corned beef is a frozen product commercially prepared by pickling boneless brisket, rump, or other selected beef cuts in a salt solution (brine). Also, it may be used for such entrées as corned beef and cabbage or for sandwiches.

- Dried beef is a frozen product commercially prepared from beef rounds cured with sugar and salt, dried, and sliced paper thin. It is normally used for creamed chipped beef on toast.

- Sausage is finely or coarsely chopped meat (pork, beef, or combination of beef and pork), seasoned with spices and herbs, that is stuffed into edible casings. Depending on the type of sausage, it may be cooked or uncooked. Check the label for cooking instructions. Types of sausages available include the following:

Pork sausage is uncooked and available in 1- to 6-pound rolls and in 3-ounce patties.

Breakfast sausage (beef and pork) is a precooked, link-style sausage; no preparation is needed except heating.

Breakfast sausage, all beef, is an uncooked, link-style sausage.

Specialty sausages can be served as a sandwich or an entrée. The following varieties are available:

Bockwurst and bratwurst are prepared from pork or beef or a combination. They are seasoned with spices and herbs and require cooking.

Knockwurst is a highly seasoned sausage prepared from beef. It requires cooking.

Italian sausage is available either mild (sweet) or hot. It is prepared from pork and requires cooking.

Pepperoni is a precooked, highly seasoned beef sausage. It is available whole or diced.

Polish sausage is a highly seasoned, thick, long smoked pork, or pork and beef sausage that is cooked. It is also known as kielbasa. It requires heating.

- Other types of specialty meats include the following:

Pastrami is precooked. It is commercially produced by curing and smoking beef with spices. Pastrami is usually served as hot slices in sandwiches.

Chitterlings are small pork intestines. They are available frozen or canned (raw or precooked).

Pigs' feet are the front feet of a pig. The product is raw and requires cooking.

Cold cuts, including pressed ham, pickle and pimento loaf, turkey roll, bologna, salami, luncheon meat, thuringer, and liver sausage, once thawed, are sliced and served for sandwiches or cold-cut platters. Bologna, salami, and luncheon meat may be grilled and served as breakfast meats.

Frankfurters, popularly called hot dogs or wieners, are similar to sausage products, but are always precooked. Only heating is required before serving. After heating, they may be served in a sandwich roll (hot dog) or as an entrée; for example, frankfurters and baked beans. There are two sizes: regular (10 links per pound) and one-fourth pound.

Scrapple is available frozen. It is made from cornmeal, pork scraps, and seasonings. To prepare, thaw, slice and fry. Check the label directions. Scrapple is usually served at breakfast.

GENERAL PREPARATION AND COOKING METHODS

Most of the meat procured for use in Navy messes is frozen. Handling procedures, before and after cooking, are extremely important in regard to sanitation as well as to economy and palatability. Meat is a potentially hazardous food. Frozen meat, improperly thawed, can become contaminated with bacteria. Uncovered meat surfaces are a perfect area for bacterial growth; therefore, long exposure of the moist surface to air should be avoided. Improper thawing also causes an

unnecessary loss of nutrients and meat juices, resulting in a decreased quality of meat.

THAWING METHODS

Frozen meat may be thawed in several ways. The preferred method is slow thawing because there is less drip loss in the meat. Meat thawed slowly yields a juicier and more palatable cooked product. On small ships with limited chill space, or whenever time is limited between meat issue and mealtime, slow thawing is not practical. The Bureau of Medicine and Surgery (BUMED) has approved the use of alternate methods that are recommended for such circumstances.

Once meat has been defrosted or thawed, it should be used as soon as possible and not refrozen. Breakouts should not exceed the amount to be served.

Preferred Thawing Method

Break out the quantity of meat required. Remove it from the shipping container, but leave the meat inside the wrappings. Thaw slowly at temperatures between 36°F and 38°F until almost completely thawed. The thawing period will vary according to the following conditions:

- Size of the meat cut (the larger the size, the longer the time required).
- Bone-in or boneless state. Bone-in meat takes less time to thaw.
- Air temperature and circulation in chill space. Moving air accelerates thawing.
- Quantity of meat being thawed in a given area. A large amount will lower the temperature of the room and decrease the thawing action. Spread the cuts out. Do not stack them. It is almost impossible to predict the exact time required to thaw meat unless there is a perfectly controlled set of circumstances. Frozen wholesale beef cuts and frozen boneless beef may require up to 48 hours to thaw at temperatures of 36°F to 38°F. Cuts from pork, veal, and lamb will probably thaw in about 24 hours under refrigerator temperatures.

Alternate Thawing Methods

If it should become necessary to thaw the frozen meat quickly, one of two methods is used. When it is necessary to use either alternate thawing method discussed next, the medical department representative (MDR) must be notified.

1. Thaw in the original sealed wrapper or container at room temperature (not to exceed 80°F) for several hours. This procedure is to be used only by small ships when the use of chill box reach-in refrigerators is not available.

2. Thaw in the original unopened container at 50°F or lower in the meat preparation room. This procedure is approved for larger ships that do not have thaw boxes or when the use of chill box reach-in refrigerators is not available.

In each alternate method, the container acts as a refrigerator and allows the meat to thaw from the outside toward the center of the package. The outside pieces remain sufficiently cold to prevent spoilage while the center is thawing.

Proper precautions should be taken to make sure potentially hazardous foods are not allowed to remain at room temperature once thawed.

COOKING FROZEN AND THAWED MEATS

Most cuts of meats should be thawed or tempered before they are cooked. Bulk ground beef, diced meat, and Swiss steak should be completely thawed before they are cooked.

Thawed meats and meats cooked while frozen are prepared exactly as chilled meats. The principle of using lower temperatures cooking is equally applicable to all meats.

Frozen Roasts

If cooked in the frozen state, roasts will require approximately one-third to one-half additional cooking time. Seasoning should be delayed until the outside is somewhat thawed and the surface is sufficiently moist to retain salt, pepper, and flour. The insertion of the meat thermometer can be delayed until the roasts are partially thawed.

Ground Meats, Diced Meats, and Swiss Steak

Ground meats, diced meats, and Swiss steak must be completely thawed before cooking. Beef pattie mix used for meatballs, meat patties, and meat loaf requires mixing with other ingredients and shaping before cooking. Since diced meats used in stews or other recipes often are dredged in flour and seasonings before browning, they must be thawed. Swiss steak also requires thawing before cooking.

Preformed beef patties with soy, 100 percent hamburger patties, grill steak pork chops, and beef patties require tempering before cooking.

To temper meat, remove from freezer and place under refrigeration for a period of time sufficient to help ease separation and handling of the frozen product. Internal temperature of the food should be approximately 26°F to 28°F. The additional time required to cook meats completely done while frozen ties up the cook's time, as well as grill space. Grill steak should never be completely thawed before grilling. Once thawed, the steaks will be dry and tough. Some styles may also fall apart.

Liver should be partially thawed to ensure a moist and palatable product and to provide slices that are uniform and attractive in appearance. If liver appears greenish after grilling, it is not spoiled.

The method used to cook meat is determined by the kind of meat and the tenderness of the cut. Tender cuts require a dry heat method. However, tough cuts require moist heat and long, slow cooking.

MOIST HEAT COOKING METHODS

Moist heat refers to cooking with added liquid or steam. Moist heat methods include braising, simmering, and stewing. These methods are used to cook less tender cuts of meat.

Stewing and Simmering

One method of moist heat cooking is stewing. It is the method used in preparing the least tender cuts of meat. Small pieces of meat cooked in water are said to be stewed; large pieces are said to be simmered. In each case, the meat is covered with water and simmered—kept just below the boiling temperature. It is never boiled. Boiling the meat for the length of time required to tenderize it will dissolve the connective tissue completely and the meat will fall apart and become stringy and dry.

Vegetables may or may not be added to the stew. If they are added, they should be cooked to the “just tender” point and should still retain their color, shape, and flavor after they are cooked. The gravy should be light and smooth and have the same flavor as the meat. The meat is dredged in seasoned flour and browned in a small amount of fat. Stews are made in a steam-jacketed kettle that has a hinged lid. The stew should be held at the simmering temperature until the meat is done, usually about 2 hours. Meat cooked in

liquid is tender and juicy and holds its shape when sliced. Usually the steam-jacketed kettle is used so that the meat can be completely submerged in the liquid at all times.

Braising

Braising is used to prepare tough cuts of meat. Check the Armed Forces Recipe Service (AFRS) for those cuts of meat that should be braised.

To braise, meat is browned in a small amount of added fat, then covered and cooked slowly in the juices from the meat or in a small amount of liquid that is added. The liquid may be water, stock, vegetable juices, thin sauces, or a combination of these liquids. Just enough liquid to start the natural juices in the meat should be used. Only a small amount of liquid should be added at a time as the color and appearance of both the meat and gravy are better if the liquid is kept to a minimum. Pot roast and Swiss steak are cooked using this method of moist heat cooking. Flavor is improved by dredging the pieces of meat in seasoned flour, then browning them in a small amount of fat, or by marinating the meat in a well-seasoned mixture of vinegar, vegetables, and spices (such as sauerbraten). Browning the meat develops flavor and aroma, and a rich brown color is typical of well-prepared braised dishes.

After the meat has been browned, the temperature is reduced, and cooking is continued at a low temperature so that the liquid will not boil. Braising may be done in the oven, on top of the range in a deep pot or in the steam-jacketed kettle. Whichever method is used, the container should be tightly covered. The aim of braising is to produce a piece of meat that is evenly browned on the exterior, tender, juicy, and evenly cooked throughout, with no stringiness. Meat cuts that are braised are always cooked to the well-done stage.

The term *boiled* that is applied to such dishes as New England boiled dinner is actually in conflict with good meat cookery principles. Boiling meats for long periods dissolves the connective tissue, causing the meat to separate. The meat becomes dry, stringy, and tough, making it impossible to carve uniform, thin slices from large cuts.

Frying

Meat may be fried in deep fat, in an oven by panfrying, or in a pan with a small amount of fat by sautéing.

PANFRYING.— Sautéing or shallow panfrying is done on the range or griddle in a pan with just enough fat to keep the meat from sticking. This method of cooking is sometimes more economical and less work when a small amount of food is to be fried

The fat should be heated to the proper temperature before the meat is placed into it; otherwise, the meat will absorb too much of the fat and will be unappetizing. The correct temperatures are indicated on the recipe cards.

Liver, any tender meats (such as grill steaks), and meat mixtures that are breaded or floured may be fried with good results.

DEEP-FAT FRYING.— Deep-fat frying is done by completely immersing the meat in heated deep fat and allowing it to remain in the fat until it is done.

Meat that is to be deep fried should be breaded to prevent an excessive loss of moisture. It is also important to have the fat at the proper temperature. If it is too hot, the exterior of the meat will brown excessively before the interior has had time to cook. If it is too cool, the meat will absorb too much fat and be greasy. A deep-fat thermometer is the only accurate way to determine the temperature of the fat.

For best results, the pieces to be fried should be of uniform size, and the basket should not be overloaded. Just enough pieces should be placed in the basket to completely cover the bottom of the fry basket. This method permits the hot fat to completely surround the meat and ensures thorough cooking. When the basket is overloaded, the fat is cooled excessively, and the hot fat cannot circulate freely.

Fry only one kind of meat or food item at a time. Fry the meat as quickly as possible and only as needed (practice batch cookery). Drain to remove excess fat after cooking, then salt or season. Never salt or season food directly over the fryer.

OVEN FRYING.— Oven frying is similar to baking or roasting except fat is added. Food may be oven fried with or without breading.

DRY HEAT COOKING METHODS

Dry heat refers to cooking meat uncovered without adding moisture. Dry heat methods include roasting, baking, broiling, and grilling. These methods are used for tender cuts of meat that have little connective tissue.

Grilling

Grill steaks, beef patties with soy, ham slices, bacon, liver, and pork sausage are suitable for grilling. In grilling, the meat is placed directly on the ungreased griddle. The heat is transmitted to the meat from the hot metal of the griddle. A moderate temperature is maintained that prevents the meat from overbrowning. Enough fat cooks out to keep the meat from sticking. Excess fat should be removed as it collects to prevent the meat from frying. Tongs or a food turner should be used to turn the meat. Do not use a fork to turn the meat because puncturing the meat with the tines of a fork allows the juices to escape. If the juices escape the meat becomes dry and coarse. Check the AFRS for cuts of beef, lamb, and pork that may be grilled.

Pork requires thorough cooking to bring out its full flavor. Braised pork chops are more desirable from the standpoint of aroma, texture, tenderness, and flavor of the lean meat. If pork chops and pork steaks are grilled, they require additional cooking in the oven to ensure complete doneness. Veal is usually not grilled because it is a lean meat and has an abundance of connective tissue that requires long, slow cooking.

Grilled meat is usually turned only once. The seasoning is applied to the cooked side just after it is turned.

Broiling

Broiling is cooking by dry heat. Conventional and continuous broilers are available in some Navy GMs. For cooking times and temperatures, check the manufacturer's directions for cooking meats. Steaks and hamburgers are generally cooked using broilers. Where broilers are not available, grills are used

Roasting and Baking

The word *roasting* describes the cooking of meat by dry heat in an oven. Any tender cut of beef, pork, or lamb may be roasted. Baking is the preparation method used in roasting ham, meat loaf, fish, and some chicken recipes.

Roasting pans should be of a heavy material with low sides that allow meat to be cooked by hot air freely circulating over and around the meat. Open pan roasting will brown roasts evenly. Do not crowd roasts. Season meat as directed on the AFRS recipes. If racks are available, place roasts on racks to allow juices and fat to drain from roasts as they are cooked.

The following rules pertaining to roasting apply to beef, veal, pork, and lamb. Included with each rule is the "why."

- Use a moderately low oven temperature (325°F) so the roast will be uniformly done throughout, the cooking losses will be moderate, the meat will be more palatable, and the roast will be plump and full. High temperatures cause excessive shrinkage, uneven cooking, and decreased juiciness and tenderness.

- Do not sear meat before roasting. Searing toughens the outer layer of meat, increases cooking losses, causes a loss of fat, and contributes to excessive shrinkage.

- Place roast fat side up on the pan. This eliminates basting; as the meat cooks, it will baste itself with the melting fat.

- Add salt to the roast before or after it is cooked. Salt penetrates less than half an inch below the surface and any salt added before the roast is cooked adds flavor to the drippings.

- Unless specified in the AFRS recipe, never cover a roast. If the roasting pan is covered, the moisture escaping from the meat will surround it and the meat will be cooked by moist heat.

- Do not add water. Roasts cooked without water are juicier and more flavorful. The only reason for adding water would be to keep the drippings from becoming too brown. This will not happen, however, when low oven temperatures are used.

- Do not flour the roast. Drippings from a floured roast may be a more attractive brown, but the same results can be obtained by browning flour in the drippings when you make the gravy.

- Use a meat thermometer to tell when the roast is done. The meat thermometer is the only accurate measure of doneness. The length of cooking time depends on the temperature of the oven, the weight and shape of the roast, and the kind of meat. A dial-type meat thermometer is shown in figure 6-5.

The thermometer should be inserted into the center of the main muscle (the thickest part of the meat) so that the tip of the thermometer does not touch the bone, gristle, or the fat. As the heat from the oven penetrates the meat, the internal temperature at the center of the roast gradually rises and this rise is registered on the thermometer. When the thermometer registers the

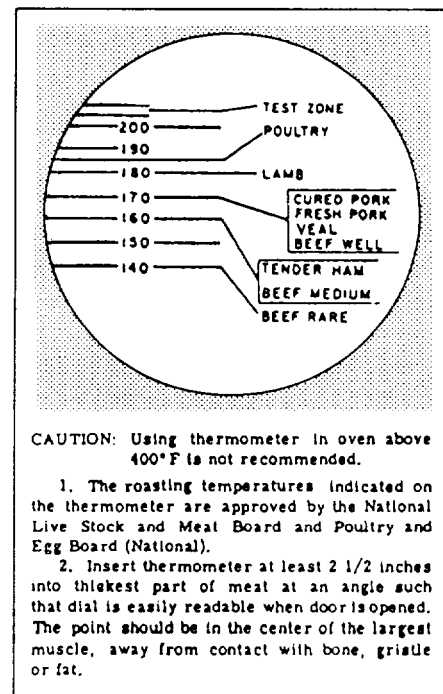

Figure 6-5.—Dial-type roast meat thermometer.

desired temperature for that particular kind of meat, the roast is ready to be removed from the oven.

- Boneless meat will require a somewhat longer cooking period than meat with bones. A smaller roast requires more minutes per pound than a larger one. Follow the AFRS recipe that specifies the type of meat required and the proper cooking temperature.

Cooking time is only a guide to meat doneness. Roasts will continue to cook slightly after being removed from the oven. Cooking time depends principally upon the size and cut of the meat, the degree of doneness desired or required, and the cooking temperature. The temperatures at which meats are cooked also determine cooking times. Maintaining even temperatures aids in predicting cooking periods. For information on convection oven cooking, check the AFRS guidelines, specific recipes, and manufacturer's directions for meat cookery.

POULTRY

Poultry is a menu favorite. Chicken, duck, Rock Cornish hen, and turkey are the main poultry items used in Navy messes.

TYPES

Various styles of chicken, duck and turkey are available for use in Navy messes.

All poultry is inspected to make sure it is free from disease and is slaughtered, dressed, and processed in a clean manner. Canned, boned chicken and turkey are also inspected for wholesomeness.

Poultry may also be graded as to quality. Grading is done according to overall appearance, meatiness, amount of fat, and the presence or absence of defects (torn skin, discoloration, bruises, and so forth). USDA grades A, B, and C are used to indicate poultry that has been officially graded. Grades B and C are not as attractive as grade A but are still wholesome. They may have defects and faulty conformation and be lacking in meat content and fat cover. Examples of grade stamps are shown in figure 6-6.

Chicken

Frozen broiler-fryer chickens weighing 3 to 3 1/2 pounds are procured in several styles:

- Whole
- Cutup



U. S. INSPECTION STAMP

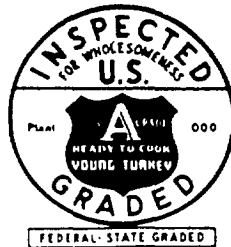

COMBINED U. S. INSPECTION AND GRADE STAMP



U. S. GRADE STAMP

Figure 6-6.—Inspection and grade stamps for poultry.

- Quartered
- Breasts
- Legs
- Thighs

• Frozen Rock Cornish hens are young chickens weighing 20 to 25 ounces that have been produced by crossbreeding the Cornish chicken with other chicken species. They require only thawing and splitting in half and washing under cold water before cooking.

• Canned, boned chicken offers space and weight savings. It needs no refrigeration and is usually stocked when freezer space is limited. Canned chicken may be used in recipes requiring diced chicken, such as chow mein, tetrazinni, baked chicken with noodles, and chicken salad.

• Frozen chicken, breaded, precooked, drumsticks and thighs and/or breast halves, is available for reheating either in the oven or in the deep-fat fryer. The product can be reheated quickly and used as an entrée item or on the speedline.

• Frozen, chicken fillet, breaded, precooked, also can be reheated quickly and used for sandwiches or as an entrée item.

• Frozen, chicken fillet, unbreaded, precooked, also can be reheated quickly and used for sandwiches or as an entrée item.

• Frozen chicken fillet nuggets, breaded, precooked, can be reheated quickly and used as an entrée item or on the speedline.

Turkey

Turkey for Navy messes is procured in the following styles:

• Frozen, whole turkeys vary widely in weight. Hen turkeys have a minimum weight of 12 pounds; tom turkeys weigh 16 to 24 pounds. Self-basting and regular whole turkeys are procured. An 8- to 12-pound whole turkey is available for use aboard submarines.

• Frozen, boneless, raw turkey rolls weigh 9 to 12 pounds and contain the same proportion of light and dark meat as whole turkey. Raw turkey rolls require cooking.

- Frozen chicken and turkey giblets are available for preparation of giblet gravy. Thaw and use according to AFRS directions.

Duck

Frozen, whole roaster ducks weigh 3 to 5 pounds and require only thawing and washing before cooking.

PREPARATION AND COOKING OF POULTRY

Poultry should be handled with strict sanitary measures during both cooking and preparation.

Preparation

Thaw frozen chicken, Rock Cornish hen, turkey, and duck before cooking. All poultry must be thawed at chill temperatures (36°F to 38°F). Never thaw in water.

Thawed poultry should never be refrozen. Refreezing lowers quality and promotes bacterial growth.

Use thawed poultry as soon as possible. Do not hold in refrigeration more than 24 hours. Longer holding lowers quality and risks spoilage.

Whole turkeys, Rock Cornish hens, ducks, and chickens are wrapped in plastic bags. Remove whole poultry from the shipping containers, but leave in the plastic bag. To speed thawing, spread them out so that air can circulate. Cutup or quartered chickens should be thawed in the intermediate carton. If this carton has an overwrapping, remove it.

Turkeys weighing more than 16 pounds require 3 to 4 days to thaw, at 36°F to 38°F. Turkeys weighing under 16 pounds require 2 to 3 days. Whole chickens and ducks require 18 to 24 hours and Rock Cornish hens need 12 to 18 hours.

Clean all poultry after thawing by removing any spongy, red lung tissue inside the back, loose membranes, pinfeathers, and skin defects. Wash poultry inside and out under cold, running water and drain. Refrigerate until needed.

NOTE: All cutting boards used for preparing poultry must be thoroughly sanitized after each use.

Cooking

Procedures for cooking whole turkeys, Rock Cornish hens, chickens, and ducks are described in the AFRS. Poultry maybe cooked using either moist or dry heat. These methods and their variations are explained as follows.

DRY HEAT METHODS.— Care should be taken to prevent the poultry skin from becoming too hard and dry while it is roasting. To prevent dryness, rub the skin of the chicken or turkey with salad oil or shortening. This is not necessary for duck because of its high fat content. If self-basting turkey is supplied, follow the package instructions for cooking. Place the poultry in an open pan, breast side up, on a V-shaped rack if available. A low oven temperature (350°F) should be used for chicken and Rock Cornish hen. Duck and turkey are cooked at 325°F.

If the bird starts browning too soon, aluminum foil may be placed over it to prevent overbrowning. The formation of a hard, dry crust can be prevented by occasionally basting the bird with pan drippings during roasting.

The Navy procures boneless, frozen, cooked, and uncooked turkey rolls. These rolls consist of light and dark meat. The instructions for preparing each type are included with the specific turkey roll and recipes in the AFRS. The boneless turkey roll is equal in quality and flavor to whole turkey, and it is easier and faster to prepare. It also permits accurate portion control, saves storage space, and eliminates waste. However, roast whole turkeys are often prepared for special meals.

As turkey is larger than most other poultry, it is more difficult to cook to the well-done stage without overdoing it. Care should be taken to cook it no longer than necessary; overcooking will result in the loss of juices and stringy, dry meat. The use of a meat thermometer inserted in the thickest part of the thigh muscle will give the internal temperature of the turkey. When the thermometer registers an internal temperature of 180°F to 185°F, the turkey has reached the required stage of doneness. The AFRS contains a timetable for roasting unstuffed turkeys.

MOIST HEAT METHODS.— In moist heat methods, the water should simmer rather than boil to avoid the toughening effect of high temperature on the fibers. Depending upon the cooking method used, temperatures will vary, but slow to moderate temperatures should be used at all times to develop maximum flavor, tenderness, color, and juiciness.

Intense heat will harden and toughen the protein, shrink the muscles, and dry out the juices, thus producing a less palatable product. All poultry should be cooked to the well-done stage. Follow the AFRS directions for preparation.

Panfrying.— To panfry poultry, wipe the pieces dry, season them with salt and pepper, and roll them in flour. If a heavier coating (crust) is desired, dip the pieces in batter or a milk and egg mixture and roll them in soft bread crumbs before they are fried. Put approximately one-half inch of frying fat in a heavy frying pan and preheat to a temperature of 360°F to 365°F. Add the pieces of poultry to the hot pan. Turn the pieces frequently. Use tongs or two spoons to turn the pieces. Do not use a fork because puncturing the meat with the tines of the fork allows the juices to escape. Cook until well-done.

Oven Frying.— Dip the pieces of poultry in flour, milk and egg mixture, then into crumbs. Place poultry in a shallow pan. Pour the fat over the pieces to ensure an even coating. Cook in the oven.

Deep-Fat Frying.— To deep-fat fry poultry, wipe the pieces dry, season them with salt and pepper, and roll them in flour. If a heavier coating (crust) is desired, dip the pieces in batter or a milk and egg mixture and roll them in soft bread crumbs before they are fried. Place enough fat in the pan to completely cover the pieces of poultry. Preheat the fat to 325°F, then carefully lower the pieces into the fat. Do not crowd. The chicken may be cooked until done, or it may be browned in deep fat and placed in the oven to complete the cooking. Always allow the fat to regain the proper temperature before reloading the fryer.

The giblets (gizzard, heart, and liver) need no preparation other than ordinary washing in cold water before cooking. One precaution—the liver should be inspected closely to detect any sign of bile contamination. The bile sack is often broken during its removal from the liver. Bile damage is easily recognizable by a greenish brown or yellow color on the liver. Any liver indicating bile damage is unfit to eat and must be discarded.

After washing the giblets in cold water, you should place them in just enough cold salted water to cover, bring to a boil, then reduce the heat and simmer approximately 1 hour or until they are tender. (Livers cook much faster than gizzards and should be cooked separately.) Save the stock and chop the giblets (do not grind) for use in the gravy or dressing. Refrigerate them until they are ready to use.

MEAT CARVING

For special occasions such as holidays, hand carving hams or roast meats on the serving line is preferred to slicing by machine in the galley.

Rules for Carving Meat

Meats carve more easily if allowed to set (cool off after cooking). The AFRS recipes specify a 20-minute period. The following rules for carving meat should be used:

- Always use clean, sanitized equipment.
- Use the proper knives for the job.
- Keep the knives sharp.
- Use a meat fork.
- Always cut across the grain of the meat and away from the body.
- Arrange meat portions in a serving pan so that you can easily remove slices without breaking them.

You should be able to carve meat portions of equal size. Meat, fish, and poultry recipes indicate the size of the serving portions.

Carving Roast Turkey

Roast whole turkey is usually carved in the galley. Let the turkey stand for about 30 minutes after it is removed from the oven before carving. This will allow the juices to be absorbed, the flesh to become firm, and the turkey can then be sliced with greater ease and efficiency. The carving techniques described as follows are the procedures that should be followed for carving turkey in the galley and will provide generous, accurate portions.

1. Use a sharp, long-bladed knife. Place the legs to your right if you are right-handed, to the left if you are left-handed.

2. Remove the leg by holding the drumstick firmly with the thumb and forefinger. Cut through the skin by drawing the knife back and forth and sever the joint. Press the leg away from the body with the flat side of the knife. Cut the remaining skin on the back. Remove the oyster (choice dark meat in spoon-shaped bone on back) with the leg.

3. Disjoint the drumstick and the thigh by holding the leg at a right angle to the board. Cut

through the meat to the bone; then, hold the thigh with the knife and press down with the other hand until the joint snaps.

4. Slice the leg meat by holding the drumstick at a right angle to the board, cutting down; turn the leg to get uniform slices. To slice the thigh, straddle the bone with a fork and cut into lengthwise strips.

5. Remove the wing by placing the knife at a right angle to the breast, about 1 1/2 inches above the wing, and cut straight through the skin and the wing joint.

6. To remove the breast from the back, insert the knife along the top and cut slowly, guide the knife along the curve of the rib section. Remove the breast in one piece. Place the breast on the slicing board and slice pieces one-fourth inch thick. You may slice the breast meat directly from the bird. Hold the bird with a fork straddling the breastbone or insert the fork in the ribs opposite the side being carved. Start the first slice just above the place where the wing was removed and with the knife parallel to the breast; use a sawing motion and cut the slices about one-fourth inch thick.

7. Arrange the sliced turkey in shallow pans; fill one-half of the pan with white meat and the other half with dark meat. Cover the pan to keep the meat moist and appetizing. A small amount of broth may be added, if desired.

8. Place the sliced turkey in the steam table inserts. Do not permit the steam table temperature to go above 200°F as the meat will become dry and continue cooking.

9. To complete the trimming of the bird, cut all remnants off the carcass. This meat can be used for sandwiches, soups, or creamed dishes.

There are two advantages to this method of carving. It ensures portion control and makes it possible to use all meat on the carcass and avoid waste.

On special occasions roasted whole turkey may be carved on the serving line. This allows everyone to see and share in the festivity that a holiday bird symbolizes.

Be sure to store all unused portions of the bird properly. Place the sliced meat on a tray and cover it loosely with waxed paper before it is placed in the refrigerator. Place trimmings and other edible

parts in the refrigerator if they are not to be used immediately.

Carving Boneless Turkey Roll

Boneless turkey roll may be roasted in the frozen state. If cooked while frozen, allow 1 to 2 hours additional cooking time. If the turkey starts to become too brown, place a piece of foil loosely over the bird for the last hour of cooking. After the turkey is roasted, let it stand for at least 30 minutes, preferably 1 hour, before it is served, so that the juices can be absorbed and the turkey can be sliced more easily and effectively.

If feasible, machine slicing of boneless turkey is preferable to hand slicing. However, regardless of what method is used, the following slicing procedures are recommended:

- Remove the netting and skin.
- Cut in slices about one-fourth inch thick.
- Place the slices in a shallow insert pan and cover with aluminum foil.

Deboning Meat and Poultry

The current availability of frozen boneless meat has practically eliminated the need for foodservice operations to do in-house butchering or deboning of meat. This has increased the capacity of total available storage area.

SEAFOOD

Like meat and poultry, seafood products are excellent protein foods and an excellent source of minerals and vitamins.

There are more than 200 species of fish and shellfish sold in the United States. If you are looking for variety, they give you more choice than any other food group. You can buy fish and shellfish fresh, frozen, and canned.

TYPES

The types of seafood procured by the Navy for use in the GM are listed next (fig. 6-7). These items are prepared and handled under contract specifications to ensure top quality. When requesting these items from a supply activity, you should clearly identify them by national stock number and description.

Type	Form	Description
Cod.....	Frozen.....	Fillets, skinless; breaded fish portions
Flounder.....	Frozen.....	Fillets, skinless; breaded fish portions
Haddock.....	Frozen.....	Fillets, skin on or skinless; breaded fish portions
Halibut.....	Frozen.....	Steaks, skin on
Perch.....	Frozen.....	Fillets, skin on or skinless; breaded fish portions, partially precooked batter-dipped fish portions
Pollack.....	Frozen.....	Fillets, breaded fish portions, partially precooked batter-dipped fish portions
Rockfish.....	Frozen.....	Fillets, skinless
Salmon.....	Frozen.....	Steaks, skin on
Salmon.....	Canned.....	Pieces
Sardines	Canned.....	Headless, packed in olive or vegetable oil
Tuna.....	Canned.....	Chunks or solid pack, packed in water
Whiting.....	Frozen.....	Fillets, skin on or skinless, breaded or partially precooked batter-dipped fish portions
Crab meat.....	Canned.....	Pieces
Crab meat	Frozen.....	Shredded, minced, cooked
Clams.....	Canned.....	Minced, packed in natural juices
Clams.....	Frozen.....	Shucked
Spiny lobster tail..	Frozen.....	Tail
Lobster.....	Fresh.....	Whole
Lobster.....	Frozen.....	Whole
Oysters (Eastern or Gulf).....	Frozen.....	Shucked, IQF
Oysters (Pacific)....	Frozen.....	Breaded, IQF
Scallops.....	Frozen.....	Shucked
Scallops.....	Frozen.....	Breaded, IQF
Shrimp.....	Canned.....	Whole
Shrimp.....	Dehydrated....	Whole, cooked
Shrimp.....	Frozen.....	Breaded, whole, deveined
Shrimp.....	Frozen.....	Whole, peeled, deveined, IQF
Shrimp.....	Frozen.....	Whole, unpeeled

Figure 6-7.—Fish and shellfish authorized for GM.

Seasonally and locally available fresh and frozen fish items are authorized for all GMs through the Department of Defense subsistence offices.

Seafood is highly susceptible to spoilage, and receipts from either Navy or commercial sources should be carefully checked for quality. Refrozen seafood should not be accepted; it will usually have soft, flabby flesh, a sour odor, and may show discoloration. Occasionally, you may have to use fresh fish on your

menu and you should be able to distinguish the good products from bad.

Fin Fish

Fish is an excellent source of protein, minerals, and vitamins. Fin fish (vertebrates) have backbones and fins. Examples include salmon, catfish, cod, flounder, haddock, perch, pollack, rockfish, trout, and whiting.

All fresh fish will spoil rapidly if mishandled. Keep under refrigeration and use within 3 days of receipt. Keep frozen fish at 0°F or below. Thaw fish at 36°F—never in water. Handle thawed fish carefully to prevent breakage. Never refreeze fish once thawed.

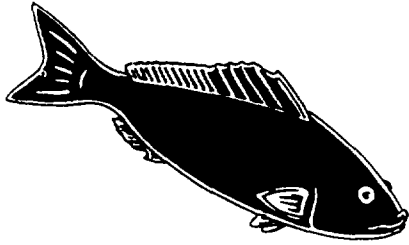

Most GMS purchase fish in the form that it will be prepared. Fresh fish may be purchased in a variety of cuts or forms as illustrated and described in figure 6-8.

When you are buying fresh fish locally, you should check for quality and freshness. Fresh fish should have the following characteristics:

WHOLE OR ROUND fish are those marketed just as they come from the water. Before cooking, they must be scaled and eviscerated (which means removing the entrails). The head, tail, and fins may be removed if desired, and the fish either split or cut into serving-size portions, except in fish intended for baking. Some small fish, like smelt, are frequently cooked with only the entrails removed.

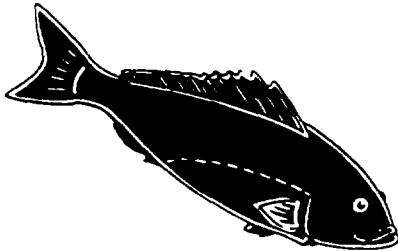

DRAWN fish are marketed with only the entrails removed. In preparation for cooking, they generally are scaled. Head, tail, and fins are removed, if desired, and the fish split or cut into serving-size portions. Small drawn fish, or larger sizes intended for baking, may be cooked in the form purchased after being scaled.

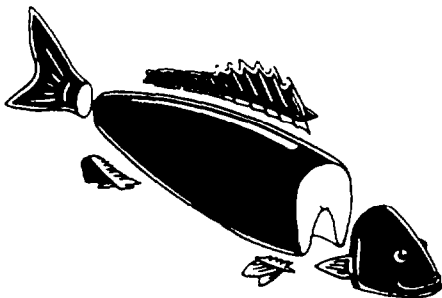

DRESSED fish are scaled and eviscerated, usually with the head, tail, and fins removed. The smaller sizes are ready for cooking as purchased (pan-dressed). The larger sizes of dressed fish may be baked as purchased but frequently are cut into steaks or serving-size portions.



Figure 6-8.—Market forms of fish.

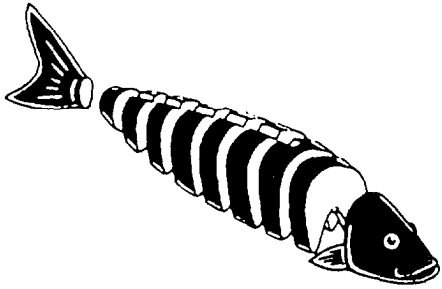

STEAKS are cross-section slices of the larger sizes of dressed fish. They are ready to cook as purchased, except for dividing the very largest into serving-size portions. A cross section of the backbone is usually the only bone in the steak.

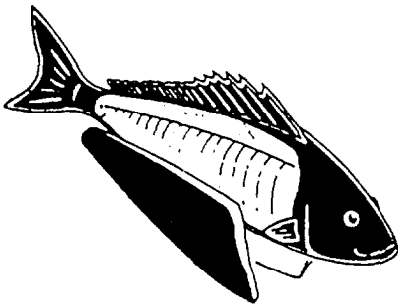

The sides of the fish, cut lengthwise away from the backbone, are called FILLETS. They are practically boneless and require no preparation for cooking. Sometimes the skin, with the scales removed, is left on the fillets; others are skinned. A fillet cut from one side of a fish is called a single fillet. This is the type of fillet most generally seen in the market.



BUTTERFLY FILLETS are the two sides of the fish corresponding to two single fillets held together by uncut flesh and the skin.

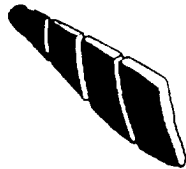

STICKS are pieces of fish cut lengthwise or crosswise from fillets or steaks into portions of uniform width and length.

Figure 6-8.—Market forms of fish—Continued.

- Eyes—bright, clear, and full
- Gills—reddish pink and free from slime
- Scales—adhering tightly to the skin, bright colored with characteristic sheen
- Flesh—firm and elastic, springing back when pressed, not separating from the bones
- Odor—fresh, free from objectionable odors

Fresh fillets, steaks, and chunks should also have a mild, fresh odor, and the flesh should have a fresh-cut appearance without any traces of browning or drying.

Frozen fish compares favorably in appearance, flavor, and food value with fresh fish and may be used interchangeably. Frozen fish should be delivered still frozen and should remain frozen until just before it is cooked.

Frozen fish fillets and steaks should be thawed gradually under refrigeration and used as soon as possible thereafter. The ideal temperature range for the thawing period is 36°F to 38°F. During the thawing period, the fish should be kept in the box just as it was received from the supplier. The box furnishes insulation that permits all the fish to thaw uniformly. If not properly protected fish is thawed at temperatures that are too high, the surface may begin to spoil before the inside is completely thawed. Frozen, breaded seafood products should not be thawed before they are cooked. In general, a few helpful rules include the following:

- The amount of fish thawed should not exceed the amount to be served.
- Fish should be thawed just before it is used; it should not be refrozen.
- Seafood products should not be thawed under cold running water.

Shellfish

Shellfish have a partial or complete shell covering. There are two classes of shellfish. Crustaceans have semihard to hard shells over the back and claws and soft shells under the body. Shrimp and lobster are examples. Mollusks have two very hard shells of the same size, which are tightly closed when the mollusk is fresh. Sort and discard any open shells before cooking. Clams, oysters, and scallops are examples.

The chief varieties of shellfish available from Navy or commercial sources for use in the GM include clams, crabs, lobsters, crawfish, oysters, scallops, and shrimp.

CLAMS.— Clams are procured as either frozen or canned minced. They are shucked and packed in natural juices. Clams are available as either frozen regular or individually quick frozen (IQF). They should not be thawed until they are to be used. IQF clams are easier to handle since only the amount needed is removed from the container. Once removed, they should not be refrozen, but they should be drained and used in chowder. Canned clams should be drained and used like the frozen ones.

CRAB LEGS.— Crab legs are a similar food item in flavor to lobster. The legs should be split before cooking. Steam or boil and serve with lemon wedges and drawn butter.

CRAB MEAT.— Crab meat is available in tamed and frozen forms. It may be used in crab cakes, salads, and sandwiches. Both forms are fully cooked and ready to use. Frozen crab meat, once thawed, should be used immediately. Do not refreeze.

LOBSTER.— Lobster is one of the largest species of shellfish. There are two types: northern lobster and spiny lobster. Northern lobster, the true lobster, is distinguished by its large heavy claws.

Whole lobsters are available fresh and frozen. When cooked, the shell turns a bright orange-red color. Fresh and frozen lobsters are very perishable. Keep fresh lobsters alive until ready to use. Do not freeze. Frozen whole lobsters are commercially available wrapped in polyethylene film. Do not thaw before cooking. Keep frozen at 0°F or below. Follow the AFRS for cooking directions. Be sure not to overcook or lobsters will be tough and dry.

Spiny or rock lobster is distinguished by the absence of large claws and by the presence of its long slender antenna and many prominent spines on its body and legs.

CRAWFISH.— Crawfish or lobster tail is sometimes called langosta and is nearly worldwide in its distribution, ranging through the tropical, subtropical, and temperate waters of the Atlantic, Pacific, and Indian Oceans. In the United States it is found in Florida and southern waters.

The meat of the crawfish comes almost entirely from the tail. The frozen tails of several species weighing from 4 ounces to more than 1 pound each are sold on the market.

OYSTERS.— Shucked oysters are those that have been removed from the shell. Shucked oysters should be plump, have a natural creamy color, have a clear liquid (natural juices), and be free from shell particles.

Fresh shucked oysters are generally packed in metal containers or waxed cartons. The cartons should be refrigerated or surrounded by ice.

Pacific and Eastern Gulf oysters are available shucked, frozen, and packed in natural juices. They are also available IQF.

IQF oysters maybe issued without thawing an entire batch, Frozen shucked Pacific oysters are larger than the East Coast varieties. All oysters, once thawed should never be refrozen. They should never be eaten raw. For best results, thaw just before cooking.

If frozen breaded oysters are to be deep fried, then keep them frozen until ready to use.

SCALLOPS.— Scallops are shellfish, similar to oysters and clams. The excellent flavored adductor muscle, sometimes called the eye, is the only edible part of the scallop.

The Navy procures frozen sea scallops. When thawed, they have a sweetish odor. Frozen breaded scallops are available. They may be deep-fat or oven fried.

SHRIMP.— Shrimp are caught in all the coastal waters from Maine to Alaska. Although shrimp vary in color when raw, they differ little in appearance or flavor when cooked. Green shrimp is a commercial term used to denote raw shrimp.

Shrimp may be procured raw, whole; raw, peeled and deveined; raw, breaded, IQF; and in breaded molded shrimp portions.

PREPARATION AND COOKING OF SEAFOOD

The type of seafood to be cooked determines the preparation and cooking method. Fish must be cooked thoroughly but not overcooked. Seafood prepared too far in advance, even though properly cooked, becomes dry, hard, and loses its flavor and succulence. Fish should be baked at a moderate temperature (375°F). It is done when it flakes easily with a fork. Cooking it too long makes it dry and tough.

Preparation

Some fat or oil should be added to practically all varieties of fish, whether light flesh or dark flesh, when they are cooked. The fat helps keep the fish moist while it is cooking and makes it more palatable. If the fish is baked, a solid fat such as butter or shortening may be “dotted” over the fish; melted fat or oil maybe brushed

on the fish; or sliced bacon or thinly sliced salt pork may be laid over the fish. If the fish is to be deep-fat fried, some fat is added to the fish through the frying process. Fat may also be added to the fish by a sauce made with fat or oil.

Simple seasoning is best for most fish. Salt and pepper should be added in moderation; monosodium glutamate also enhances the flavor. Lemon juice and the milder herbs such as parsley are good seasonings. Seasonings may be added to the fish or placed around it in a baking pan, or they maybe incorporated into a sauce or a basting liquid that creates steam and helps to keep fish moist and flavorful. When fish is cooked in a liquid or a sauce, both the fish and the sauce should be lightly seasoned to avoid a salty product.

Cooking

Generally it is best to fry lean fish, such as haddock or flounder, and broil or bake fat fish, such as salmon or mackerel. However, you may broil or bake lean fish if you baste it frequently with melted fat or if you cook it with a sauce to avoid dryness.

BAKING.— You can bake fish of almost any size provided there is enough oven space. Place the fish on a greased pan and brush it thoroughly on both sides with melted butter or margarine. Sprinkle it with the appropriate seasoning and bake at 375°F for 35 minutes or until lightly browned.

PANFRYING.— You can panfry small whole fish or serving-size fillets or steaks. To panfry breaded fish fillets or steaks, follow these procedures:

1. Place the fish fillets or steaks that have been dredged in a mixture of crumbs, flour and pepper, on a sheet pan containing one-eighth inch of shortening. The shortening should be hot, but not smoking.
2. Brown the fish on one side. Turn it carefully, and brown it on the other side. Use moderate heat.
3. Drain the fish and serve hot. Garnish with chopped parsley or lemon wedges.

DEEP-FAT FRYING.— Do not thaw breaded frozen fish portions before cooking them. If you thaw them, the breading may fall off or become tough and dark during the frying process. If this happens, the natural juices of the fish will be lost. Cook frozen portions in fat heated to 350°F for 3 minutes or until lightly browned. Drain well in a basket or on absorbent paper.

You can deep-fat fry small, whole fish or serving-size fillets and steaks. Thaw the fish. Then dip it in an egg-milk mixture, drain it, and roll it in a mixture of bread crumbs and flour. Shake off excess coating. Cook fish in fat heated to 365°F for 4 minutes or until browned. Drain well in a basket or on absorbent paper.

COOKING SHELLFISH.— Shrimp, oysters, and scallops are usually breaded and deep-fat fried. Serve them either separately or in a seafood platter. Drain oysters in a colander after they thaw and remove any pieces of shell. Cook breaded shrimp and scallops in deep fat at 350°F. Fry breaded oysters in deep fat at 375°F.

NUTRITION AND MENU PLANNING

One of your most important duties as a senior Mess Management Specialist (MS) is to see that the general mess (GM) customers are always well fed. To be well fed means that they should have not only enough food but also the right kind of food in the proper combinations; that is, foods containing the correct amounts of the various nutrients necessary to good health and well-being. To accomplish this, the menus must be carefully and skillfully planned to produce the right combinations of food in dishes that will appeal to the personnel to whom they are served. This should be accomplished within your budget and with the food items you have had the foresight to stock on board. This service must be carried out afloat and ashore, consistently, under varying operating conditions, in widely differing geographic locations, and in all kinds of weather.

The purpose of this chapter is to provide you with the information and guidance needed in the areas of menu planning, and nutrition, and ultimately, in the supervision of other personnel in this area.

The foodservice division is a customer service oriented division, and customer satisfaction is one of our primary goals. We should take every opportunity to motivate the personnel who man the contact points (galley, serving line, and mess area), whether civilian or military, to do their best and to take pride in the caliber of service they provide their shipmates. Motivating our personnel in these positions provides a special challenge to the senior MS. We should make sure the personnel manning these contact points realize that they are part of a people-oriented team, that they are an important part of our Navy, and that the positions they hold at these contact points are positions of special trust that support our most important resource-our Navy men and women.

NUTRITION

Nutrition is the science of the nourishment of the human body, the science of food. To master this science we should familiarize ourselves with the nature of food. Food is composed of various nutrients: proteins, carbohydrates, fats, minerals, vitamins, and water.

Nutrition concerns itself with determining what components are needed and how much of each is required to maintain healthy bodies. Nutrition concerns itself with the ways in which foods are altered in processing, storage, and preparation, and in the ways in which foods are transformed chemically in the body. Nutrition deals with the preparation and serving of foods in such a way as to make sure the nutrients necessary to good health are not unnecessarily lost in the process. In addition, nutrition should be concerned with the social, economic, cultural, and psychological implications of foods.

When you prepare your next meal, the patrons will have definite ideas-positive or negative-about the meal and the specific foods that are served. They may delight in the variations in the texture, in the color combinations of the food, in the artistic touch of a garnish, or they may find the food unacceptable because the fuel lacks color or is carelessly served. They may enjoy the tantalizing smell of meat, of freshly baked rolls, or the fragrance of fully ripened fruit. The odor of grease that has been too hot or of vegetables that have been cooked too long may cause lack of appetite and even nausea. The patrons will experience countless flavors-the salty, sweet, bitter, and sour tastes and their variations; they will feel the textures of smooth or fibrous, crisp or soft, creamy or oily, moist or dry foods. The provision of a nutritious diet, well cooked and attractively served, plays an important part in the acceptability of a meal.

FOOD CONTENT

Food is any substance consisting essentially of protein, carbohydrates, fats, minerals, vitamins, and water that is used in the body to sustain growth, to build and repair tissues, to furnish energy, and to sustain the vital processes of the body. The body's needs for the various nutrients vary with age, sex, occupation, and environment. A child needs certain foods to grow and the body continues to require certain foods for its upkeep. Vitamins, minerals, and proteins provide regulators that enable the body to use other materials. Fuel for the body's energy and warmth is provided by food.

Calories

A knowledge of the calorie content of food is important to you as an MS. Your skill in developing healthy menus plays a critical role in the support of the physical fitness and personal appearance of Navy personnel. The role of the foodservice division in meeting this need is providing lower calorie food choices. Some low-calorie food choices include low-calorie salad dressing; salads and relishes (raw vegetables); skim and/or low-fat milk; fresh and/or tamed fruit drained of syrup; lean meat, poultry, fish, or seafood without added high-calorie sauces or gravies; a vegetable choice without added fat; and light desserts in smaller portions. Think-thin menus are planned using the same principles and standards used for the general menu and should be based on the general menu. Think-thin menus should include all the basic menu components while eliminating high-calorie extras such as gravies, sauces, and toppings. Calorie content is influenced by preparation methods and portion size. Guidance on planning low-calorie meals, low-fat food preparation, and think-thin portion sizes of Armed Forces Recipe Service (AFRS) recipes is contained in *Foodservice Operations*, NAVSUP P421.

Food Nutrients

There are six types of food nutrients. Most of us can get enough of these nutrients by eating foods from the major food groups each day. These nutrients are discussed next.

PROTEINS.— The chief function of protein in the body is to supply the tissue-building material. Protein itself is a chemically complex organic substance that contains nitrogen in combination with carbon, oxygen, and hydrogen. In the process of digestion, these substances break down into smaller units called amino acids. These units, in turn, are rebuilt into body protein. Certain amino acids are necessary for maintaining growth, weight, and good health. Foods are classified as protein foods only when they contain protein in sufficient amounts to be of value when the food is consumed in normal amounts.

Animal protein foods—meat, poultry, fish, eggs, milk, and milk products, such as cheese—contain the necessary amino acids essential to body structure. The protein in cereals, vegetables, and legumes lacks some of the important amino acids and alone cannot support growth. However, vegetable proteins such as dried beans, dried peas, and peanuts can supplement the animal proteins, and when they are served in the proper

combination can provide all the essential amino acids without the addition of any animal protein.

FATS.— Fats provide twice as much energy and calories as do carbohydrates or protein. Fats are important in the diet to furnish energy, provide essential fatty acids, transport fat-soluble vitamins and aid in their absorption, increase palatability, and give a feeling of fullness. However, it is becoming increasingly clear that excessive amounts of total fat may lead to an increased risk of coronary heart and vascular diseases. Emphasis should be placed on planning menus toward attainment of lower fat concentrations while maintaining acceptability. A significant reduction of fat can be achieved by lowering added fats during food preparation and increasing the proportion of lean meats, fish, poultry, skim milk, and other low-fat dairy products in the menu.

CARBOHYDRATES.— Carbohydrates are generally low in calories and fat and high in fiber. Complex carbohydrates are found in grains, vegetables, and legumes such as dried beans and split peas. Nutritionists recommend that we get at least 55- to 60-percent of our calories from complex carbohydrates. Complex carbohydrate foods play an important role in weight control. They supply the body with energy in a constant, time-released manner. Since carbohydrates supply sustained energy, athletes should get 60- to 70-percent of their calories from carbohydrates. Carbohydrates are stored in the muscles as glycogen, which is essential for endurance. Additionally, a diet high in the soluble fiber found in legumes, fruits, vegetables, and some grains may play a role in lowering blood cholesterol.

MINERALS.— Twenty known minerals are essential to health. Some of the more important minerals will be explained next.

Calcium.— The most abundant mineral in the body is calcium and, except for iron, it is the most likely to be inadequate in the diets of many age groups. (From the age of 9, the diets of many girls and women may lack as much as 25 percent to 30 percent of the calcium they need.) Almost all calcium, and most phosphorus, which works closely with calcium in the body, is in the bones and teeth.

The rest plays a vital role in tissue and body fluids. Soft tissue, or muscle, also has a high phosphorus content. Calcium is required for blood to clot and for the heart to function normally. The nervous system does not work properly when calcium levels in the blood are below normal.

In the United States we rely on milk as a basic source of calcium, and 2 cups of milk, or an equivalent amount of cheese or other dairy products except butter, go a long way toward supplying all the calcium needed for the day.

But milk is not the only source. Dark green leafy vegetables, such as collards, mustard greens, or turnip greens, provide some calcium, and salmon and sardines supply useful amounts of it if the very tiny bones are eaten.

Phosphorus.— Phosphorus is necessary for building bones and teeth. Milk, cheese, eggs, meat, legumes, nuts, whole grain cereals, and vegetables are good sources of this mineral.

Iron.— Iron carries oxygen in the blood. The best sources of iron are meats (especially liver). But foods from some plants, such as dried beans, dark green leafy vegetables, and grains, are good sources of iron, especially when eaten along with foods rich in vitamin C. Vitamin C helps the body absorb iron better.

Iodine.— The most important fact about iodine is that a deficiency of it can cause a goiter—a swelling of the thyroid gland. Important sources are seafoods, plants grown in the soil near the sea, and iodized salt, which is used in all Navy messes.

Salt.— Salt is needed by everyone. A person needs about 1 level teaspoon of salt per day and more when a person perspires a great deal. The average intake of salt is from 2 to 3 teaspoons daily, which is enough for a person drinking up to about 4 quarts of water. A person who is not getting enough salt will become weak.

Many Americans eat more salt and sodium than we need. Salt contains sodium and is already present in many canned or processed foods. Excess salt contributes to high blood pressure in some people.

Sodium (salt) has been reduced in AFRS recipes to minimum acceptable levels. Sodium can be further reduced in recipes by using the following guidelines:

- Season food with herbs and spices instead of high-sodium items like salt, soy sauce, or steak sauce.
- Choose fresh rather than canned food items.
- Look for prepared foods that say low or reduced sodium on the label.

VITAMINS.— There are about 13 vitamins that are absolutely necessary for good health. Four are called fat-soluble vitamins because they dissolve in fat. These are vitamins A, D, E, and K. They are digested and absorbed with the help of fats from the diet. These vitamins can be stored in the body for long periods of time, mostly in fatty tissue and in the liver.

Nine other vitamins are called water soluble. They include eight B vitamins and vitamin C. These vitamins are not stored in the body very long, so you need to eat foods that are good sources of these vitamins every day.

A few of these vitamins are of great importance and you should know what foods provide them.

Vitamin A.— This vitamin plays a very important role in eye function and in keeping the skin and mucous membranes resistant to infection. Although vitamin A occurs only in foods of animal origin, the deep yellow and dark green vegetables and fruits supply a material—carotene—that your body can turn into vitamin A.

Vitamin A is found in yellow, orange, and green vegetables; yellow fruits; and in the fat of animal products like fish, milk, eggs, and liver. Both cheese made from whole milk, and margarine enriched with vitamin A supply this vitamin.

Vitamin C.— Vitamin C, ascorbic acid, is not completely understood, but it is considered important in helping to maintain the cementing material that holds body cells together. Vitamin C is needed for wound healing; for development of blood vessels, bones, teeth, and other tissues; and for minerals to be used by the body.

Vitamin C is found in citrus fruits, melons, berries, leafy green vegetables, broccoli, raw cabbage, spinach, and turnip and collard greens. Potatoes and sweet potatoes provide helpful amounts of vitamin C and so do tomatoes and peppers.

Vitamin D.— Vitamin D is readily available in fortified milk. Sunlight enables the body to produce this vitamin if it has a chance to shine directly on the skin. Vitamin D is needed for using calcium and phosphorus to build strong bones and teeth. Vitamin D is added to most milk. It is also found in fatty fish, liver, eggs, and butter.

Vitamin E.— Vitamin E helps preserve the cell tissues. Although vitamin E's exact role in the body is not fully understood, it is being explored as an antioxidant that may retard some aspects of the aging

process. Vitamin E is found in a wide variety of foods, and most people get enough. Vegetable oils and whole grain cereals are particularly rich sources.

Vitamin K.— Vitamin K is essential because it indirectly helps blood to clot. Vitamin K is widely distributed in a variety of foods such as the green and leafy vegetables, tomatoes, cauliflower, egg yolks, soybean oil, and any kind of liver. It is also manufactured in the body.

Three of the best known B vitamins-riboflavin, thiamine, and niacin-release the energy in food. They also have a role in the nervous system, keep the digestive system working calmly, and help maintain a healthy skin.

Thiamine (B1).— Thiamine is abundant in only a few foods. Lean pork is one. Dry beans and peas, some of the organ meats, and some nuts supply some thiamine.

A lack of thiamine (vitamin B) causes beriberi. Fortunately, this disease is now almost nonexistent in the United States, although it is still seen in some alcoholics.

Riboflavin (B₂).— Riboflavin is easy to find and extremely important in the diet. It is plentifully supplied by meats, milk and whole grain or enriched breads and cereals. Organ meats (liver, kidney, and so on) also supply this vitamin.

Niacin.—Niacin (nicotinic acid) prevents a disease called pellagra. It aids in digestion and the health of the skin.

Whole grain and enriched cereals and bread are dependable sources of niacin. Niacin also can be found in meat and meat products and peas and beans.

Other B Vitamins.— Other B vitamins, such as B₆, B₁₂, and folacin, are needed to maintain normal hemoglobin-the substance in blood that carries oxygen to the tissues. Vitamin B₁₂ occurs in foods of animal origin. Folacin helps in the production of red blood cells and is available in many foods but in small quantities. Sources of folacin are liver, green vegetables, whole grains, and dry beans.

Strict vegetarians run a risk of developing the symptoms of B₁₂ deficiency; these include soreness of the mouth and tongue, numbness and tingling in the hands and legs, anemia and loss of coordination.

WATER.— Water is often called the forgotten nutrient. It is needed to replace lost body water, Water helps transport nutrients, remove waste, and regulate body temperature.

CONSERVING NUTRIENTS.— It is not enough just to select the proper foods for the menu. They must be prepared in such a way that valuable nutrients are not lost. Table 7-1 presents summary information about vitamins. In addition to listing foods that are good sources of vitamins, it also shows conditions under which the vitamin content may be reduced and the effect of their deficiency in the diet. This information will be valuable to you in making and analyzing menus, and also in conserving vitamins during cooking. The term *stability* used in the illustration refers to the ability of the various substances to withstand destruction under the conditions mentioned.

The following cooking rules, if followed, will make your meals more nutritious and add to the general health of the crew.

- Serve fresh fruits and vegetables as soon after you receive them as possible.
- Handle fresh fruits and vegetables carefully because bruising causes a rapid loss of vitamins.
- Store fresh fruits and vegetables properly until they are to be used.
- Do not soak vegetables in water longer than necessary to freshen or clean them. Water will dissolve vitamins B₁, B₂, C, and minerals.
- To cook vegetables, place them in rapidly boiling water. Bring the water back to a boil and reduce to a simmer.
- Cook vegetables quickly and just until tender in order to leave them with some of their original crispness.
- Cook vegetables in as little water as possible.
- Do not throw away cooking water. Save it for use in soups, sauces, and gravies.
- Heat canned vegetables quickly just before serving.
- Shred outer leaves of lettuce, cabbage, and green leaves of celery for use in flavoring soups.
- Serve fruits and vegetables raw in salads.

Table 7-1.-Summary Information on Vitamins

Chemical name	A	C	D	Vitamin B complex		
	Carotene	Ascorbic acid	Calciferol	Thiamine (B ₁)	Riboflavin (B ₂)	Niacin
Important food sources	Liver Egg yolk Vegetables Green Yellow Butter Cream Fish-liver oil	Citrus fruits Cabbage Tomatoes Cantaloupes Strawberries Potatoes in jackets	Fish-liver oil Butter Egg yolk Liver	Pork Liver Organ meats Nuts Legumes Whole wheat Whole grains Wheat germ	Liver Meats Eggs Milk Enriched bread Vegetables Green Leafy	Meat Fish Poultry Liver Green peas
Stability: cooking & drying light	Gradual destruction by exposure to heat and drying at high temperature.	Unstable to heat and oxidation, except in acids. Destroyed by drying and aging.	Stable to heating, aging, and storing.	Unstable to heat and oxidation.	Stable to heat in cooking, to acids and oxidation. Unstable to light.	Stable to heat, light, and oxidation, acids and alkalis.
Lack of this vitamin causes	Night blindness; Glare blindness, Rough dry skin Dry mucous membrane	Scurvy Sore mouth Stiff joints Sore and bleeding gums Weak-walled capillaries	Rickets Soft bones Bowed legs Poor teeth Skeletal deformities	Beriberi (man) Poor appetite Constipation Fatigue	Eye sensitivity Cataract	Pellagra

- Prepare fruits and vegetables for salads just before serving.
- When salmon salad is prepared, save the juice and use it in salad dressing or as a part of the liquid for salmon loaf or sauce.
- Prepare hot foods just in time to be served. Never prepare them early and reheat them.

The foods that we eat each day must supply the proteins, carbohydrates, fats, minerals, and vitamins that are needed to maintain the body in a healthy condition. Most foods contain more than one nutrient, but no single food provides all the nutrients in proper quantities. Therefore, it is necessary for the diet to include a variety of foods, and this is accomplished through well-planned menus.

Menu planners should judge the nutritional adequacy of their menus and special rations. Detailed analysis of nutrients is not required if the menu includes a wide variety of foods and the food guide pyramid for daily food choices is used. This pyramid provides a simple, quick, and reliable method of judging the menu's nutritional adequacy. The guide divides commonly eaten foods into five major food groups according to the nutritional contributions they make.

FOOD GUIDE PYRAMID

In April 1991, the Secretary of Agriculture unveiled the food guide pyramid, which replaced the basic four food groups.

This pyramid (fig. 7-1) is a visual companion to the Dietary Guidelines for Americans. The new graphic conveys the three essential elements of a healthy diet: proportion, moderation, and variety.

- Proportion is the relative amount of food to choose from each major food group.
- Moderation is eating fats, oils, and sugars sparingly.
- Variety emphasizes the importance of eating a selection of different foods from each of the major food groups every day.

Table 7-2 illustrates the range of caloric intake and servings needed from each major food group based on activity level. **NOTE:** The minimum suggested servings on the pyramid are the minimum number of servings needed each day to stay healthy, even when trying to lose weight.

The food pyramid graphically communicates the message of the Dietary Guidelines for Americans—diets should be built upon a base of complex carbohydrates and less fat. The placement of the food groups starting at the base of the pyramid conveys the current recommendations. These recommendations are as follows: eat more grains, vegetables, and fruits; eat moderate amounts of lean meats and dairy foods; and

use sweets, fats, and oils sparingly. The food guide pyramid graphic (fig. 7-1) shows that all food groups are important to the diet.

Grain, Cereal, Rice and Pasta Group

The food pyramid emphasizes whole grain and cereal foods as the basis of a nutritious diet. Wheat, corn, oats, and other grains have very little fat and are cholesterol free. These foods provide complex carbohydrates—an important source of energy, especially in low-fat diets. They also provide fiber.

A person needs **6 to 11 servings** from this group daily, depending on their activity level. You should offer whole grain and enriched or fortified products, but be sure to include some whole grain bread or cereals.

WHAT IS A SERVING?— It includes all products made with whole grain or enriched flour or meal such as bread, biscuits, muffins, waffles, pancakes, cooked or ready-to-eat cereals, cornmeal, flour, grits, macaroni and spaghetti, noodles, rice, rolled oats, and barley.

The following are some examples of a typical serving from the grain group:

- 1 slice of bread
- 1/2 cup of cooked cereal, cornmeal, grits, macaroni, noodles, rice or spaghetti

Table 7-2.—Range of Caloric Intake and Servings Needed Based on Activity Level

Calories:	Sedentary 1,600	Active 2,200	Very Active 2,800
Servings of:			
Breads and grains	6	9	11
Vegetables	3	4	5
Fruits	2	3	4
Milk and dairy products	2 to 3*	2 to 3*	2 to 3*
Meat group (oz)	5	6	7
Total fat (g)	53	73	93
Total added sugar (tsp)	6	12	18
*Pregnant women, nursing mothers, teenagers, and young adults to age 24 need three servings.			

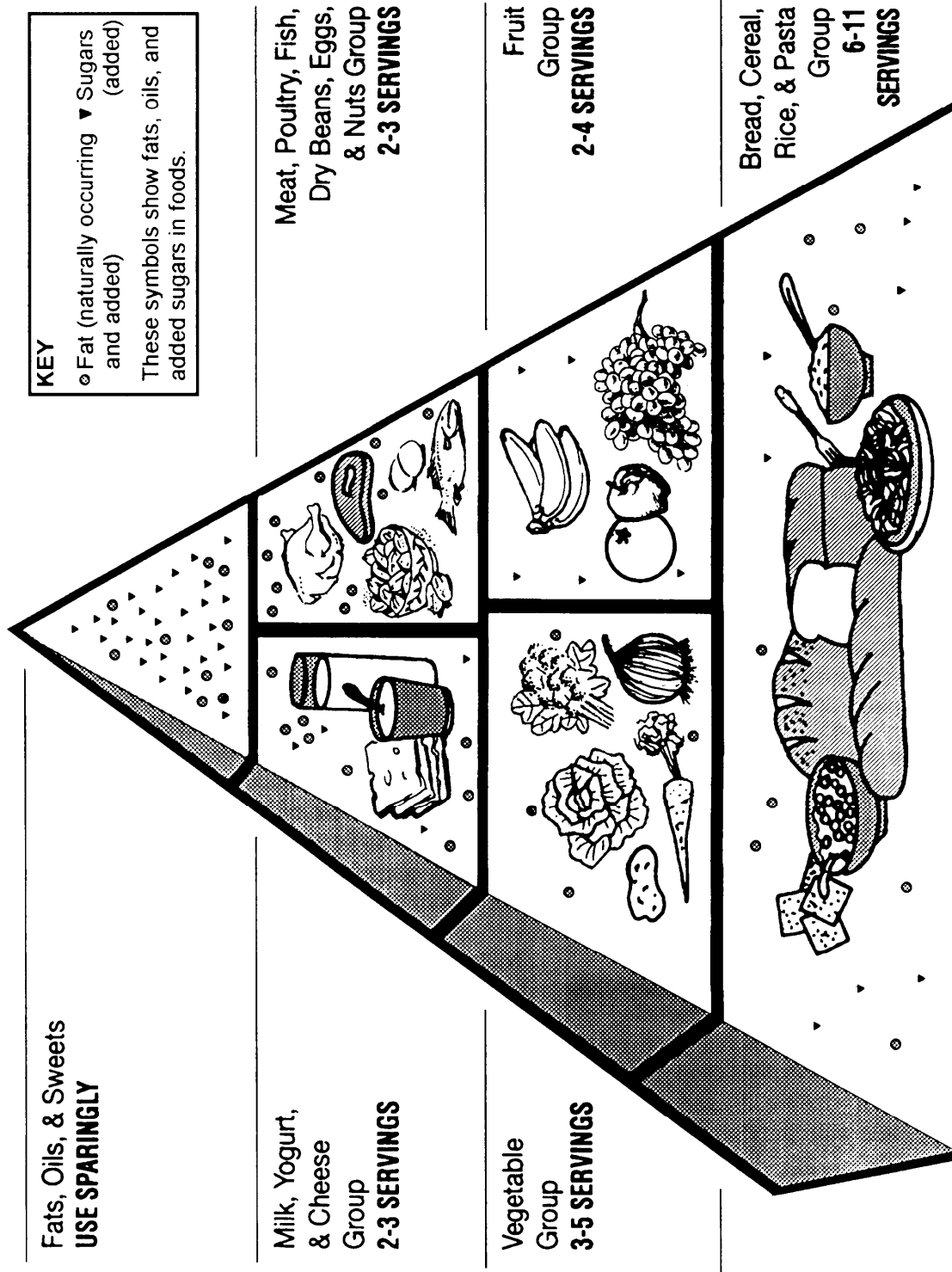

Figure 7-1.—The food guide pyramid for daily food choices.

. 1 ounce of ready-to-eat cereal

NUTRITIVE VALUE.— These whole grain or enriched foods are important sources of B vitamins and iron. They also provide protein and are a major source of this nutrient in vegetarian diets. Additionally, they contribute magnesium, folacin, and fiber.

Most breakfast cereals are fortified at levels higher than those occurring in natural whole grain. In fact, some fortification adds vitamins not normally found in cereals (namely, vitamins A, B₁₂, C, and D). However, even these cereals (if refined) and other refined products (enriched or not) maybe low in some other vitamins and trace minerals. This is because these nutrients are partially removed from the whole grain in the milling process and not replaced. Thus, it is a good idea to include some less refined or whole grain products in your menu.

Vegetable Group

Vegetables are naturally low in fat and contain no cholesterol. They provide vitamins such as vitamins A, C, and folate, and minerals such as iron and magnesium. Vegetables also provide fiber. Unlike the traditional “basic four,” the food pyramid separates vegetables and fruits into individual groups to highlight how important it is to get adequate amounts of both.

Because vegetables are so important, GM menus should offer two hot vegetables at both lunch and dinner meals whenever possible. This gives the patrons a choice they will enjoy and improves the nutritional profile of the meal. You should note that the portion size of cooked vegetables was increased to 3/4 cup in the *Armed Forces Recipe Service*, NAVSUP P-7, in September 1992.

A person needs 3 to 5 servings daily, depending on their activity level. You should include one good vitamin C source each day. Also include deep yellow or dark green vegetables (for vitamin A) and unpeeled vegetables, especially those with edible seeds (for fiber).

WHAT IS A SERVING?— It includes all vegetables. You should count the following as a serving from the vegetable group:

- 1 cup of raw leafy vegetables
- 1/2 cup of other vegetables that are cooked or chopped raw
- 3/4 cup of vegetable or tomato juice

NUTRITIVE VALUE.— Different types of vegetables provide different nutrients; therefore, your menu should feature a variety of vegetables. Dark green and deep yellow vegetables are good sources of vitamin A. Most dark green vegetables, if not overcooked, are also reliable sources of vitamin C. They are also valued for providing riboflavin, folacin, iron, and magnesium. Certain greens-collard, kale, mustard, turnip, and dandelion-provide calcium. Nearly all vegetables are low in fat, and none contain cholesterol.

Fruit Group

Most fruits are low in fat and free of cholesterol. Fruits and fruit juices provide important amounts of vitamin A and potassium. The food pyramid suggests a person receive 2 to 4 servings daily from this group, depending on their activity level.

WHAT IS A SERVING?— It includes all fruits. You should count the following as examples of a serving from the fruit group:

- A medium apple, orange, or banana.
- 1/2 cup of chopped, cooked, or canned fruit.

1/2 cup of fruit juice. You should only count 100-percent fruit juice as fruit.

NUTRITIVE VALUE.— Any kind of fruit fits into a low-fat diet. Nearly all fruits are low in fat, and none contain cholesterol. This group is also important for its contribution of vitamins A and C and fiber. As with vegetables, different types of fruits provide different nutrients. Reliable sources of vitamin C are citrus fruits (oranges, grapefruits, lemons), melons, and berries. Fruits with skin have more fiber.

Milk, Yogurt, and Cheese Group

Milk products provide protein, vitamins, and minerals as well as fat, cholesterol, and calories. Milk yogurt, and cheese are the best sources of calcium. The food pyramid suggests 2 to 3 daily servings of milk, yogurt, or cheese each day, depending on a person's activity level. Most people only need 2 servings. However, 3 servings are suggested for pregnant women, nursing mothers, teenagers, and young adults to age 24. Young adults should continue to have 3 servings of the milk group until age 24. This is to ensure a calcium intake that allows the development of peak bone mass during the formative years.

WHAT IS A SERVING?— It includes milk in any form such as whole, skim, low-fat, evaporated,

buttermilk, and nonfat dry milk. A serving also may consist of yogurt, ice cream, ice milk, and cheese, including cottage cheese. You should count the following as examples of a serving from the this group:

- One 8-ounce cup of milk or yogurt
- 1 1/2 ounces of natural cheese
- 2 ounces of processed cheese

NUTRITIVE VALUE.— Milk and most milk products are relied on to provide protein, calcium, phosphorus, and vitamins A, B₁, B₂, and B₁₂. In fact, milk and most milk products are the major source of calcium in the American diet. Also, liquid milk is fortified with vitamin D, which aids in the absorption of calcium. When fortified with vitamins A and D, low-fat or skim milk products have essentially the same nutrients as whole milk products, but fewer calories and less fat content.

Some dairy products contain large amounts of fat and cholesterol. However, low-fat dairy products contain equivalent amounts of calcium. To provide lower fat choices for your patrons, cook with nonfat dry milk; serve 1 percent low-fat and skim milk; offer low-fat yogurt and lower fat milk desserts, like ice milk or frozen yogurt. Include cheese scheduling in your menu planning. For example, au gratin potatoes and club spinach both have cheese. Therefore, limit to one dish of either per meal.

Meat, Poultry, Fish, Dry Beans, Eggs, and Nuts Group

The food pyramid suggests 2 to 3 servings each day from this group, depending on a person's activity level. The total amount of these servings should be equivalent to 5 to 7 ounces of cooked lean meat, poultry, or fish per day.

WHAT IS A SERVING?— It includes beef, veal, lamb, pork poultry, fish, shellfish (shrimp, oysters, crabs, and so on), organ meats (liver, kidneys, and so on), dry beans or peas, soybeans, lentils, eggs, seeds, nuts, peanuts, and peanut butter.

Counting to see if you have an equivalent of 5 to 7 ounces of cooked lean meat can be difficult. This is because portion sizes vary with the type of food and meal. For example, 6 ounces may come from one egg for breakfast (count as 1 ounce of lean meat); 2 ounces of sliced turkey in a sandwich for lunch; and 3 ounces of cooked hamburger for dinner.

NUTRITIVE VALUE.— Meat, poultry, and fish supply protein, B vitamins, iron, and zinc. The other foods in this group—dry beans, eggs, and nuts—are similar to meats in providing protein and most required vitamins and minerals.

It is a good idea to vary the choices among these foods as each has distinct nutritional advantages. For example, red meats and oysters are good sources of zinc. Liver and egg yolks are valuable sources of vitamin A. Dry beans, dry peas, soybeans, and nuts are worthwhile sources of magnesium. The flesh of fish and poultry is relatively low in calories and saturated fat. Some seeds such as sunflower and sesame contribute polyunsaturated fatty acids that are an essential part of a balanced diet.

Cholesterol, like vitamin B₁₂, occurs naturally only in foods of animal origin. All meats contain cholesterol, present in both the lean meat and the fat. The highest concentration is found in organ meats and in egg yolks. Fish and shellfish, except shrimp, are relatively low in cholesterol. Dairy products also supply cholesterol.

The meat group is an excellent place to trim the fat in the diet. Contrary to popular belief, red meat does not need to be avoided. Red meat is a good source of protein, iron, zinc, and several other important nutrients. The idea is to cut down on large servings of meat-not eliminate it entirely. Fish is naturally low in fat and so are dry beans and peas.

To reduce fat from the meat group, choose lean meats most of the time; take the skin off poultry; trim any extra fat off meat; eat more fish, dry beans, and peas. Trim the fat off meat; broil, roast, or simmer, instead of frying. Nuts and seeds are high in fat, eat in moderation.

The following are some lean meat choices that you should incorporate into your menu:

- Beef—roast or steaks from the round, loin, sirloin, or chuck arm cuts.
- Veal—all cuts except ground.
- Lamb—roasts or chops from the leg or loin cuts.
- Pork—roasts or chops from the tenderloin, center loin, or ham cuts.
- Chicken and turkey—light and dark meat without skin.
- Fish—most are low in fat, those marinated or canned in oil are higher.

Fats, Oils, and Sweets

Fats, oils, and sweets are at the top of the food pyramid and should be used sparingly. A low-fat style of eating allows room for use of some fats and high-fat foods. The idea is balance and moderation. The food pyramid suggests using added fats such as butter, margarine, and salad dressing sparingly. It is helpful to notice the amount of fat in these foods. Most of the added sugar in the American diet comes from soft drinks, candy, jams, jellies, syrups, and table sugar. Choose fewer foods that are high in sugars—candy, sweet desserts, and soft drinks.

MENU PLANNING

Menu planning in the Navy means devising meals that are nutritionally adequate and acceptable to the patrons. The term *providing for food needs* means that enough nourishing food must be served to satisfy the needs of the patrons and that this food should be attractive and acceptable to these personnel. This service must be accomplished consistently under varying afloat and ashore operating conditions in widely different geographic locations, using the foodservice capabilities of your ship or station.

FACTORS AFFECTING MENUS

Many factors affect the menu planner's choice of foods for the menu. Nutritional requirements, portion preferences, food costs, and availability of supplies are discussed next.

Nutrient Levels

Navy menus should be planned according to the principles of menu planning set forth in *Foodservice Operations*, NAVSUP P-421. In the menu-planning and nutrition education chapters of this publication, guidelines for Navy GMs are given that will meet the nutritional standards established by the Surgeon General. Menu-planning principles in *Foodservice Operations* are revised when nutrient standards are revised by the triservice nutritional standards regulation (*Nutritional Allowances, Standards, and Education*, AR-40-25, NAVMEDCOMINST 10110.1, AFR 160-95). These military recommended dietary allowances (MRDAs) are adapted from the most current National Academy of Sciences/National Research Council publication *Recommended Dietary Allowances*. Nutritional science is in a growth phase.

New guidelines are based on new understandings of the relationship of nutrition and health.

Monetary Allowances

Economic factors invariably concern all menu planners. GMs are operated on a monetary ration allowance. The Navy Food Service Systems Office (NAVFSSO) publishes a list of fixed unit prices quarterly. This is used in pricing food items issued to the messes and in the monetary values of the basic daily allowance, supplementary allowances, and special allowances. The value of the basic allowance is developed from the standard Department of Defense Food Cost Index that contains a representative list of specific quantities of food items derived from the Navy Ration Law and the current Defense Personnel Support Center Price List. The basic daily food allowance is sufficient to feed a full daily ration under normal operating conditions. It is expected that, with proper management, an underexpenditure will exist at the end of the accounting period. This requires effective menu planning, control of issues, correct inventory procedures, food conservation programs, and a daily review of ration costs.

Food Item Restrictions

Food item restrictions should be considered. The *Federal Supply Catalog, Group 89, Subsistence*, lists all the food items procured for the armed services. Only foods listed and coded on the NAVSUP Form 1059 may be used in Navy GMs.

To request a new food item, consult the introduction to the *Federal Supply Catalog, Group 89, Subsistence*, for Navy procedures.

Seasonal Availability of Food Items

Seasonal availability of food is important in that menus should be adjusted to take advantage of seasonal changes in the supply of fresh produce. Canned, frozen, or dehydrated fruits, juices, and vegetables supplement the fresh menu items and are comparable in nutritive value.

Equipment Personnel, and Storage Facilities

Limited storage space, especially on small craft deployed on long cruises, prevents the use of many perishable food items. Menus for these activities should plan to use custom foods extensively to take best advantage of available storage space. Menus for such

cruises should be planned well in advance to assure balanced stocks that will enable you to prepare nutritious meals.

The choice of preparation of foods to be served will also depend upon the galley equipment, the number of personnel to be fed, and the number of MSs on duty.

Menus may be more elaborate if laborsaving equipment is available and a sufficient number of MSs are on duty to allow for the preparation of last-minute items. In summary, determining the choice of menu items should include the following considerations:

- The type and capacity of the galley equipment
- The number of personnel to be fed
- The number of workers in the galley

Avoid menus that require too much last-minute preparation. Plan a balance between the foods that can be prepared in advance without deteriorating in quality and those that must be prepared just before serving time.

Presentation Factors

Foods that look good and complement each other always have an advantage over those that are less attractive, even though they may be equally well prepared and nutritious. Learn to choose and combine foods in such a way as to achieve variety and harmony, both in appearance and flavor. The following suggestions will help you:

- Vary the methods of preparation of the food served. Carrots, for example, can be served raw, buttered, french fried, seasoned with lemon juice, or combined with peas.

- Consider the color of the food selected. Choose colors that look well together. Avoid too many foods of the same color at any one meal.

- Avoid the use of unsuitable colors for food. Serve interesting combinations of flavors. Combine mild and strong flavors but do not kill a delicate flavor with an unsuitable flavor combination. Avoid using the same flavor twice in the same meal.

- Combine different shapes such as diced potatoes, sliced meats, and leafy vegetables.

- Do not plan all soft, dry, or moist foods for any one meal. Vary the texture.

- Review the cycle menu each time it is used. Generally, avoid having the same meal on the same day of every week.

MENU-PLANNING TOOLS

The skill of the menu planner is reflected in the meals served in the Navy. Developing skill in appraising operating conditions, food acceptance, and food supplies in terms of potential meals is a demanding and responsible task. To accomplish these tasks, you should develop the following skills:

- Gain basic knowledge of menu-planning principles
- Balance meals in nourishing and attractive combinations of foods
- Keep food costs within unjustifiable limitations and prescribed monetary allowances
- Plan for efficient food supply management and logistics

Flexibility and adaptability are essential to the proper planning of meals. Rarely will you be able to use standard menus. The foods that are written into your ship's menu should vary as operating conditions vary. Even ships of the same type as yours, operating under the same conditions and in the same area, probably could not use exactly the same menus. The ability to adapt menus is a skill you must acquire.

The most important sources of guidance for menu planning are described in this section.

Food-Preparation Worksheet

The Food-Preparation Worksheet, NAVSUP Form 1090, is a very important document and should be properly maintained. This form serves as a written directive between the leading MS and the personnel on watch. A food-preparation worksheet should be prepared for each space in which food is prepared. The food-preparation worksheet will prove its worth to you when you use it regularly because it provides much information and guidance.

The worksheet helps reveal the strengths and weaknesses of the menu. When the preparation of the daily menu is plotted on a worksheet, weaknesses and bottlenecks stand out vividly. For example, you may find that all menu items are to be prepared in the same three steam-jacketed kettles or that the three main menu

items are to be oven-prepared, each item requiring a different oven temperature.

The worksheet helps you plan and organize the work to be performed by your subordinates. The information written in the Start Preparation, Start Cooking, and Instructions columns will help subordinates plan their work. Careful planning avoids the problem of having too much food prepared ahead of serving time.

The worksheet helps you to supervise the work performed by your subordinates. As a written directive, the worksheet is your way of communicating instructions concerning the preparation of the day's menu to subordinates. You cannot depend on your memory nor can you expect subordinates to depend on their memory.

The worksheet helps you to train subordinates who will be responsible for a galley operation in the future. Discuss the worksheet with your watch captains so that they know exactly how the menu is to be prepared. Point out the supervisory techniques you want them to use in their working relations with the crew. After each meal, meet with your watch captain and key personnel to critique the meal. This is the ideal time to discuss the acceptability of menu items and to record the acceptability on the worksheet. The critique session provides the information essential to promote efficient operations.

If your personnel are accustomed to following a worksheet, give the watch captains the experience of developing one. Let each watch captain prepare the worksheet on a monthly basis, plan the day's work discuss premeal preparation, and hold postmeal critiques. Delegating the development of the worksheet to the watch captain is excellent training if the leading MS is readily available to advise, guide, and monitor discussions and critiques.

Finally, the worksheet serves as a means for establishing control of (1) issues to the GMs (the quantities posted on NAVSUP Forms 1059 or 1282 should agree with the quantities needed to prepare the number of portions specified), (2) the quantity of each menu item prepared, (3) the portion size served, and (4) leftover menu items. Completed worksheets on file provide the invaluable past history needed for establishing controls. The acceptability of menu items will determine the quantity to break out, quantity to prepare, and any change in portion size.

Acceptability Factors

Customer acceptability of the menu is a major goal of the menu planner. There is no set pattern to indicate what foods the patrons will eat and enjoy. An individual's food tastes may be influenced by many factors, such as likes and dislikes before entering the service, the foods one has learned to eat and enjoy during a service career, and the group of friends one eats with at mealtime. The menu planner should know the customers so that the meals planned will be well accepted. The following are ways that the menu planner can determine the acceptability of specific foods in the mess.

A food acceptance factor is one that expresses the percentage of people who eat a particular dish. To obtain an acceptability factor for individual menu items, divide the number of portions of the item served by the number of patrons in attendance at the meal.

Keep a record of menu item acceptance on the Food-Preparation Worksheet, NAVSUP Form 1090, the individual recipe card, or the Index of Recipes.

An acceptance factor is a valuable index of the popularity of menu items and should be used for this purpose after an item has been tested at several meals. Acceptance factors for the same menu item may vary from meal to meal. Different combinations of foods on a menu, different weather, or varying appetites may alter the acceptance of an item. A more accurate acceptance factor may result by averaging figures obtained for a particular menu over a period of time.

Another way to determine acceptability is to keep a systematic check on plate or tray waste. This should be recorded on the food-preparation worksheet. (See figs. 7-2 and 7-3.)

Good food acceptance means less plate waste and fewer leftovers to account for in planning future meals. Even popular foods may become monotonous if served too often.

Food Preference Ratings

The fact that the patrons will take or accept items on the serving line does not prove that these are their preferred foods; they may take it merely because they have no better choice.

Food preferences or attitudes toward foods may be determined by several approaches. One approach is to solicit written opinions from the crew regarding items or classes of foods when you have doubts about their

SIGNATURE OF LEADING MS		A FLOAT						
FOOD-PREPARATION WORKSHEET (4061) NAVSUP FORM 1090 (REV. 8-82) S/N 0108 LF-501-0901		REVIEWED BY (Signature)	DATE					
LEADING MESS MANAGEMENT SPEC		DAY	8 Sept					
ACTIVITY		REVIEWED & RECEIVED BY	START COOKING					
RECIPE CARD	MENU ITEM	INSTRUCTIONS	START PREPARATION					
			PORTIONS LEFT OVER					
			MEAL ALLOWED %					
			MEAL					
			ACCEPTED ACTIVITY (%)					
			COMMENTS/DISPOSITION OF LEFTOVERS					
			PREPARED					
			UNPREPARED					
C1	Buttered rolled oats		15	103	Discarded		182	179
F7	Grilled eggs to order		20	47	Saved, use for inflight		240	245
L2	Grilled bacon slices		175	99	Saved		250	187
L36	Minced beef on toast		50	32	Discarded			
Q06-2	Hashed brown potatoes		142	79	Discarded			
A 023	French toast puff		84	63	Discarded			
018-7	Glazed doughnuts		200	29	Saved			
AP	Chilled apples		AR	79	Saved, use for inflight			
CN	Chilled grape juice		200	41	Discarded			
P2-1	Chicken noodle soup		85	41	Discarded			
L35	Baked meat loaf		200	40	Discarded			
016	w/brown gravy		170	18	Saved			
Q57	Mashed potatoes		185	35	Saved, serve with dinner			
Q6-3	Buttered green beans		136	97				
Q17-1	Glazed carrots		75					
L M47	Tossed green salad		210					
M58	w/French dressing		95					
M70	w/Thousand Is. dressing		120					
N6-3	Grilled ham & cheese sand.		48					
AP	Potato chips		AR					
G12-1	Iced Devil's food cake		270					
P4-1	French onion soup		45					
L155-	Southern fried chicken		185					
016-2	w/chicken gravy		82					
G5-2	Tossed green rice		178					
Q6-3	Buttered brussel sprouts		30					
N 06-3	Corn on cob		165					
N20	Stimmed franks w/buns		20					
M9	Creamy cole slaw		135					
M25	Fruited gelatin		100					
H24	Peanut butter cookies		200					

ON NORMAL WORKDAYS ONLY ONE WATCH CAPTAIN'S SIGNATURE REQUIRED; ON WATCH-RELIEF DAYS BOTH THE RELIEVED AND RELIEVING WATCH CAPTAINS WILL SIGN.

THE 200 PORTIONS ON L35 WERE BASED ON PREVIOUSLY RECORDED 83% ACCEPTANCE FACTOR AGAINST 240 PREDICTED MEAL ATTENDEES. TO COMPUTE THE 79%, SUBTRACT THE 11 LEFTOVER PORTIONS FROM THE 204 PORTIONS PREPARED WHICH EQUALS 193. DIVIDE 193 BY 245 (ACTUAL NUMBER OF ATTENDEES) WHICH EQUALS 78.8% ROUNDED TO 79%.

Figure 7-2.—Preparation of an afloat Food-Preparation Worksheet, NAVSUP Form 1090.

ASHORE

SIGNATURE OF FOOD SERVICE OFFICER AFTER REVIEW

ASSIGNED BY FOOD SERVICE OFFICER

FOOD-PREPARATION WORKSHEET (4081)
 NAVSUP FORM 1090 (REV. 8-82)
 SIN 0108-LF-501-0900

REVIEWED BY (Signature) _____ DATE 8 Sept

DOCUMENT NO. _____ DAY Monday

REVIEWED & RECEIVED BY _____

LEADING MESS MANAGEMENT SPEC. _____

REVIEWED & RECEIVED BY _____

SIGNATURE OF LEADING MS _____

RECIPE CARD	MENU ITEM	PORTIONS TO PREPARE	ACTUAL PREPARED	INSTRUCTIONS	START PREPARATION	START COOKING	PORTIONS LEFT OVER	ACCEPT. ABILITY (N)	MEAL	ALLOWED	%	PREDICTED	ACTUAL
C1	Buttered rolled oats	120	120					22	Breakfast			526	519
F7	Grilled eggs to order	328	362					70	Lunch			910	930
F8-3	Cheese omelets	160	155	ON NORMAL WORKDAYS ONLY ONE WATCH CAPTAIN'S SIGNATURE REQUIRED; ON WATCH-RELIEF DAYS BOTH THE RELIEVED AND RELIEVING WATCH CAPTAINS WILL SIGN.				30	Dinner			675	625
L2	Broiled bacon slices	472	485					92					
L36	Minced beef	152	150					27					
Q46-2	Hash brown potatoes	385	400	ENSURE GOLDEN BROWN				77					
DZ3	French toast puff	372	375	Garnish w/powdered sugar	0530	0545	6	71					
P2-1	Chicken noodle soup	178	180	Add chopped parsley				15					
L35	Baked meat loaf	516	524	Slice on the line				2					
O16	w/brown gravy	472	472					26					
L71-2	Grilled ham steaks	322	320	Garnish with pineapple slices				4					
Q57	Hashed potatoes	550	550	Start w/200 portions, 50-portion batches to follow				22					
Q67	Candied sweet potatoes	270						3					
Q6-3	Buttered green beans	524	485					7					
Q17-1	Glazed carrots	218	225					8					
P4-1	French onion soup	115	115	Use beef base	1445	1515	22	15					
L155-1	Southern fried chicken	405	420	Separate white & dark meat on line	1300	1330	20	64					
O16-2	w/chicken gravy	278	278		1445	1500	15	42					
L13	Pepper steaks	266	270	Slice onions vice chop	1400	1500	4	43					
E5-2	Tossed green rice	200	222	Garnish with pimento strips	1430	1445	15	33					
Q57-1	Duchess potatoes	250	250		1430	1450	8	39					
Q6-3	Buttered brussel sprouts	238	240	Have melted butter available on line - not on sprouts	1515	1530	57	29					
					1430	1500	6	81					

THE 160 PORTIONS OF F8-3 WERE BASED ON A PREVIOUSLY RECORDED 30% ACCEPTANCE FACTOR AGAINST 400 MEAL ATTENDEES. TO COMPUTE THE 30%, SUBTRACT THE 1 LEFT OVER PORTION FROM THE 155 PORTIONS PREPARED WHICH EQUALS 154. DIVIDE 154 BY 519 (ACTUAL NUMBER OF ATTENDEES) WHICH EQUALS 29.9% ROUNDED TO 30%.

COMMENTS/DISPOSITION OF LEFTOVERS
 PREPARED: 6 (Discarded)
 UNPREPARED: 15 (Discarded), 2 (Discarded), 26 (Discarded), 4 (Saved in cook's box), 22 (Saved), 3 (Discarded), 7 (Discarded), 8 (Discarded)

Figure 7-3.—Preparation of an ashore Food-Preparation Worksheet, NAVSUP Form 1090.

relative popularity. A questionnaire may be developed on which the patrons indicate their preference for various items. The manner in which the foods are described, the instructions given with the questionnaire, and where and when it is filled out are important factors to consider if you are to obtain good reliable data.

The most commonly used food preference questionnaire is a rating scale given to each person attending the meal or at some other appropriate time. This type of questionnaire is easily tabulated and is reliable because checking or circling a block is all that a person is required to do.

Food preference questionnaires can determine which single food items are most or least popular, their desired frequency of use on a menu, and what menu combinations are most or least liked. An example of how to canvass for opinions on single food items is given in figure 7-4. These food preference questionnaires should be updated periodically because tastes change, new personnel come aboard, and new items are procured.

Another type of questionnaire used may prove beneficial to the menu planner and the MS. This questionnaire is completed by the MS on watch concerning the meal just prepared. (See fig. 7-5.)

Food Usage Records

A 42-day menu with valid acceptability factors can be used to estimate the requirements for a 45-day (42 actual) load out. Add one-third of initial requirements for a 60-day (56 actual) period. By doubling the initial requirement, the time can be extended to a 90-day (84

FOODSERVICE DIVISION	
Date _____	
List below any information that will be beneficial in the future planning of menus. All Mess Management Specialists are encouraged to write comments concerning the meal you just prepared.	
Color _____	
Texture _____	
Taste _____	
Equipment _____	
Manpower _____	
Variation _____	
Additional Comments _____	

Figure 7-5.—Foodservice division questionnaire.

CIRCLE ONE ANSWER AFTER EACH FOOD						
	FOOD ITEM					
Not tried	Steamed frankfurters	Like very much	Like moderately	Neither like nor dislike	Dislike moderately	Dislike very much
Not tried	Pineapple and cottage cheese salad	Like very much	Like moderately	Neither like nor dislike	Dislike moderately	Dislike very much
Not tried	New England dinner	Like very much	Like moderately	Neither like nor dislike	Dislike moderately	Dislike very much
Not tried	Buttered green lima beans	Like very much	Like moderately	Neither like nor dislike	Dislike moderately	Dislike very much
Not tried	Scalloped potatoes	Like very much	Like moderately	Neither like nor dislike	Dislike moderately	Dislike very much

Figure 7-4. Sample food preference questionnaire.

actual) period, and soon. Type commanders establish operational endurance requirements; the 42-day cycle can be easily adapted to the type commander's requirements.

A first consideration in advance menu planning should be balanced requisitioning. Past usage records help attain this balance by showing what is on hand and what items are needed. Planning calendars of stock rotation will prevent a rewrite of menus to incorporate surplus stocks of on-hand items. Items should be rotated on a regular basis, oldest stocks should be used first.

Menu-Planning Guides

A menu planner needs to be well informed. Sources of information kept within easy reach will be valuable in planning menus. Previous menu plans on file will give a good indication of what is practical for the preparation facilities and number of personnel served at a particular location.

FOODSERVICE OPERATIONS, NAVSUP P-421.— Navy menus should be planned according to the principles of menu planning set forth in *Foodservice Operations*, NAVSUP P-421. In the Menu Planning and Nutrition Education chapters of this publication, guidelines for Navy GMs are given that will meet the nutritional standards established by the Surgeon General.

STANDARDS OF FOOD SERVICE, NAVSUPINST 4061.11.— Section I of this instruction, Menu Planning and Food Preparation, establishes updated menu-planning standards that can be attained by all Navy GMs to assure wholesome, nutritious meals.

ARMED FORCES RECIPE SERVICE, NAVSUP P-7.— The AFRS, NAVSUP P-7, consists of a file of approximately 1,800 recipes and recipe variations printed on 5- by 8-inch cards. The cards are color-coded to make identification easier. The AFRS includes color photographs of certain recipe finished products, guideline cards, and line drawings of bread and sweet roll makeup procedures. The recipes are standardized to generally yield 100 portions and include efficient preparation techniques. The Index of Recipes, an adjunct to the AFRS, is a compact list of all recipes contained in the recipe service. Continuous use of the Index of Recipes in planning menus will help avoid menu monotony and will provide ideas for new menu combinations. Commands are encouraged to send their favorite recipes to NAVFSSO for consideration for

inclusion in the AFRS. All recipes are tested and evaluated for militarywide acceptability and adaptability.

The AFRS is a basic tool for requisitioning and planning workloads. Cost records for individual recipes and recipe acceptability factors may be added to the recipe cards. Recipe cards are also used to obtain a plan for the most efficient use of galley equipment. The use of local recipes is encouraged. Local recipes should be in AFRS format and approved by the food service officer.

NAVY FOOD SERVICE, NAVSUP P-476.— This publication is a quarterly publication of NAVFSSO and is distributed to all activities having GMs. The publication contains useful information on commodities, equipment for galley use, GM modernization, revisions to publications, suggested special event or holiday menus, nutrition, sanitation, training, hints on food preparation, foodservice operations, menu planning, and recordkeeping.

Meal Attendance Predictions

Ashore units use signature head counts to document actual personnel fed. Afloat units underway receive full ration credit for all enlisted personnel entitled to be fed in the GM. A mechanical counting device should be used to determine ration credit for in-port periods based on the number of meals actually fed. There are variations in meal attendance from day to day and meal to meal. Head count records should be kept to show how many people were served at each meal. Estimates of future attendance are based on past records and experience. Factors such as weather, proximity to payday, and liberty trends must be taken into account when predicting attendance.

CYCLE MENU SYSTEM

The cycle menu system is the menu rotation plan recommended for use in Navy GMs. The cycle menu is a series of menus planned to be used consecutively with some variations over a period of time. A cycle menu, rotated with appropriate changes on a quarterly or seasonal basis, is recommended for Navy GMs. They should be reviewed continuously to increase variety and eliminate unpopular dishes. Cycle meals save time and are easier to analyze thoroughly and to perfect than those written on a weekly basis. Cycle menus also lend themselves to more forecasting of ration costs and

requirements for requisitioning and daily food preparation.

In some messes, a family night is offered once or twice a month. This affords the family and friends the opportunity to visit the command and enjoy a meal and pleasant conversation. It also stimulates morale, promotes good will, and makes family members feel more a part of the Navy.

Advantages of the Cycle Menus

The principal advantages of a cycle menu are better meals, time savings, improved cost control, and more effective supervision and training.

While the cycle menu is in use, the menu planner can refine the menu and make changes—tailoring it to patrons' preferences, available supplies, and incorporating seasonal fruits and vegetables and special events. Breakout quantities can be brought closely in line with actual requirements when menus are repeated. The cycle period can consist of as many weeks or months as practical.

In deciding the most desirable cycle length, the variety and frequency of resupply and the number of duty sections should be taken into consideration as well as the MS watch schedule. Because the accepted cook watch is port and starboard, an odd-numbered day cycle (21 days) allows each watch the opportunity to prepare the entire cycle menu by the time the cycle has repeated two times (42 days).

Varying the Cycle Menu

Perfecting the basic menu and introducing variety can be made easier with sample cycle menus available from other sources. Past menus may be used as a guide if they have gained acceptance.

Experience gained through actual preparation and service of the menu points out shortcuts, better preparation techniques, proper timing of food preparation, the arrangement of food on the serving line, preferred serving sizes, and the most attractive arrangement of food on the trays. Supervisors can provide the level of training and supervision required to perfect each meal.

If the daily ration control record shows that the cost of the meals in the cycle menu is excessive or is grossly below the allowed ration rate, the menu can be changed to bring costs within acceptable limits. If inventories point out stocks that are either in long or short supply,

temporary adjustments to the cycle menu can be made to balance stocks.

Adjusting Meals for Climate

The menu is seasonal in the sense that plans are altered to include the special foods featured for each season. Foods in season have a higher quality, are usually cheaper, and are better flavored.

Adjusting Navy meals for the climate should also take into account the great variation in climatic conditions under which Navy ships and shore stations operate. Menu plans should be made to suit the weather in which you are operating. Food needs differ, and appetites usually change with variations in temperature. Crisp, cool, fresh finds are appealing to the patron in hot weather. Heavier, heartier foods such as hot soups, stews, and hot cereals are welcomed in cold weather. Fresh fruits and vegetables are at their highest quality and lowest price at seasonal peak. In hot weather, a variety of beverages, including fruit juices, should be available.

LOADING GUIDES.— The best guides for planning menus and determining loading requirements are accurate records of a ship's own past usage and menu plans or menu summaries of previous extended cruises. Usage data and menus used during extended cruises should be collected to provide a basis for balanced loading for future deployment.

The 45-day Subsistence Endurance Base (SEB) contained in *Food Service Management*, NAVSUP P-486, volume I, is a guide that can be used with ship's usage data in planning menus and load lists for 60-, 75-, 90-, and 120-day operational endurances.

Menus not only affect the health and morale of the crew, but also directly affect the endurance of a ship. Endurance requirements vary among ship types and classes, and the amount of food storage space varies even between ships with identical complements. Proportionately smaller quantities of perishable foods are available on extended cruises, and this calls for increased use of semiperishables, particularly ration-dense foods.

FREQUENCY CHARTS.— Developing a meat plan, frequency charts, and spacing patterns are necessary preplanning functions that assure an acceptable, appealing menu that is also within the daily monetary allowance.

A meat plan (fig. 7-6), also called a meat block shows the number of times the various types of meat (including breakfast meats), fish, poultry, and cheese are to be used each week on the cycle menu. This planned usage is directly related to the relative costs of these items, their relative popularity, and their availability. A planned pattern of usage during the cycle menu period

will enable you to balance the use of expensive, moderately expensive, and inexpensive meat items.

Construction.— The menu planner uses past menus that have known acceptability, the inventories of stocks on hand, and the *Federal Supply Catalog, Federal Supply Group 89, Subsistence*, as guides for developing the meat plan. When the meats have been chosen, they

MEAT, FISH, POULTRY ITEMS	NUMBER MEALS/WEEK						TOTAL MEALS
	1	2	3	4	5	6	
LUNCH, DINNER							
<u>BEEF</u>							
OVEN ROAST	1		1		1		3
POT ROAST		1		1		1	3
SWISS STEAK	1		1		1		3
GRILLED STEAK	1		1			1	3
GROUND	2	1	2	2	1	2	10
PATTIES	1	2	2	1	2	1	9
DICED			1				1
LIVER	1		1		1		3
FRANKFURTERS		1		1		1	3
<u>HAM</u>							
CANNED	1		1		1		3
COOKED, FROZEN	1	1		1		1	4
<u>PORK</u>							
DICED			1			1	2
PORK LOIN		1		1			2
PORK CHOPS	1		1		1	1	4
SPARERIBS	1				1		2

Figure 7-6.-Sample meat plan.

are plotted on a frequency chart, spaced on a spacing pattern, and finally entered on the menu draft.

Frequency charts and spacing patterns form the framework of the menu and like the meat plan, are developed before the menu is drafted.

Frequency charts are developed for each major menu item or section; that is, the meat, poultry, fish entrées, potatoes or potato substitutes, vegetables, salads, desserts, soups, and breads that form the basic menu structure. These charts serve as the advanced plotting of what to feed at which meal (breakfast, lunch, or dinner) and how often. An example of a vegetable frequency chart is shown in figure 7-7.

Spacing patterns (fig. 7-8) show when the item will be served. With a spacing pattern, the menu planner can plot a balanced distribution of food items so that there is an appropriate interval between the less popular items that are served, and so that the menus are not beef heavy or corn heavy.

Revision.—An important step in the final review of cycle menus is the use of the frequency chart to check the menu for repetition. This is done by listing the number of meals containing each type of food. Then checking that the spacing of similar items, such as ground beef, is adequate, that different methods of preparation are used, and that the basic menu features a

<u>1</u> VEGETABLES	<u>2</u> 1st week			2d week			3d week			4th week			5th week			6th week			<u>3</u> TOTAL TIMES SERVED		
	B	L	D	B	L	D	B	L	D	B	L	D	B	L	D	B	L	D	B	L	D
Corn (10 meals)																					
Fresh																					
—on the cob		1																		1	
—whole grain					1					1							1			2	1
Canned																					
—cream style			1										1							1	1
—whole grain							1				1					1			2	1	
Onions																					
Dry	1			1		1		1	1				1	1					3	2	2
Dehydrated		1			1					1									1	3	
Carrots																					
Fresh		1				1									1					1	2
Canned			1					1				1								1	2

1. ITEM Column: List major menu items and not recipe components (such as flour, salt, butter). This list reflects the food preferred and the varieties or forms in which the foods are available. As food preferences change or availability of certain items is altered, the foods listed may be adjusted.

2. WEEK Columns: Each weekly column is divided into three columns representing breakfast (B), lunch (L), and dinner (D). This breakdown assists in planning the distribution of the same major menu items among these meals over a 42-day period. If over a 6-week period, corn is planned for 10 meals, the chart shows: Frozen on the cob corn the 1st week, once at dinner; frozen whole grain corn, 2d and 4th week, once at lunch, and 6th week, once at dinner; canned corn, cream style, 1st week, once at dinner, 3d and 5th week, once at lunch; canned whole grain corn, 1st and 6th week, once at lunch, 4th week, once at dinner.

3. TOTAL TIMES SERVED Column: This is subdivided into three meals to assist in estimating breakout requirements. It indicates the number of times major menu items are served at specific meals over the 42-day period.

Figure 7-7. Sample vegetable frequency chart.

WEEK	MEAL	MONDAY	TUESDAY	WEDNESDAY	THURSDAY	FRIDAY	SATURDAY	SUNDAY
1	B	BACON	SAUSAGE PATTIES	GRILLED HAM	CANNED LUNCHEON MEAT	BACON	GROUND BEEF	BACON
	L	GROUND BEEF	CANNED SALMON, COOKED BONELESS HAM	PREFORMED BEEF PATTIES	PORK ROAST	SWISS STEAK	FRANKFURTIERS	CHICKEN, CUT-UP
	D	PORK SLICES	BEEF ROAST	BONELESS TURKEY	GROUND BEEF PEPPERONI (PIZZA)	PERCH, SHRIMP, FISH PORTIONS, COOKED BONELESS HAM	POT ROAST	PREFORMED PATTIES
2	B	SAUSAGE PATTIES	BREAKFAST STEAKS	BACON	CORNED BEEF HASH	SAUSAGE PATTIES	BACON	CANNED HAM
	L	CORNED BEEF HASH	PREFORMED BEEF PATTIES	FISH PORTIONS, SALAMI, CANNED HAM, CHEESE (SUBS)	DICED PORK	COOKED BONELESS HAM	DICED BEEF	BONELESS TURKEY
	D	SWISS STEAK	PORK SLICES	CHICKEN, CUT-UP	BEEF ROAST	LIVER GROUND BEEF	PORK ROAST	POT ROAST

1. SHOW THE CUT OR TYPE OF MEAT, FISH, OR POULTRY PLANNED FOR EACH MEAL, NOT THE RECIPE NUMBER.
2. PLAN AN EVEN DISTRIBUTION OF ENTRÉES TO PREVENT MENUS FROM BECOMING "PORK HEAVY" OR "BEEF HEAVY."

Figure 7-8.— L-Sample meat spacing pattern.

variety of dishes. It is particularly important to check the meal plans for the first 3 days at the beginning of the first week's menu and the end or last 3 days of the preceding week's menu in the cycle. Revise the frequency chart by eliminating identical or similar items served too close in succession.

MENU BOARDS.— Menu boards assist in planning menus that are based on crew preferences. There are two kinds of menu boards: (1) a menu-planning board that actually plans the menu within the foodservice division and (2) a menu-review board that functions in an advisory capacity.

Menu-Planning Board.— A menu-planning board acts on major decisions affecting food supplies, on the selection of food choices commensurate with galley equipment, workload, and other administrative decisions. The menu-planning board should be

composed of personnel with foodservice experience. The menu-planning board consists of MSs from the foodservice division.

Menu-Review Board.— The menu-review board consists of personnel from all divisions on board. This board can bring in new ideas on menu planning. All commanding officers formulate their own policy as to the number of board members. Menu boards, their requirements and functions, are discussed in *Foodservice Operations*, NAVSUP P-421.

Menu Changes.— The commanding officer may grant written permission to the food service officer to make necessary changes in the approved menu. Such authorization may be furnished in the ship or supply department organizational manual. Under this authority the food service officer may make changes in the menu necessary to meet any emergency that might arise. At

the discretion of the commanding officer, a weekly summary of menu changes made and the reasons for the changes are provided to the commanding officer at the time the forthcoming weekly menu is submitted for approval.

Each menu should include a notation at the bottom of the menu stating that "The food service officer is authorized to make changes to this menu when, due to unusual or unforeseen circumstances, it may be necessary to provide substitutions for food items not in stock or to permit timely use of perishable foods."

Menu changes should be kept to an absolute minimum and should not be made without advance approval by the food service officer.

SELECTIVE MENUS.— A selective (multiple-choice) menu includes one or more choices for the crew in each category. One or more choices are recommended under the following circumstances:

- If a popular entrée or vegetable is to be served, offer an alternative.
- When a high-calorie, high-fat entrée is to be served, offer an alternative.
- If savings can be realized by offering a high-cost entrée with a low-cost one, offer a choice.
- If practical from a production standpoint, a selection of various meal components can be offered, including entrées, vegetables, breads, and beverages.

DRAFTING THE MENU.— To do the best possible job in menu drafting the Navy menu planner needs a good working atmosphere in which to think. In addition, the sources of information mentioned earlier in this chapter—the meat plan, the frequency charts, and the spacing patterns that have been developed—are needed.

Most meals are planned around main dishes of meat, and other food items are planned to complement main dishes.

Use the standard Menu Draft, NAVSUP Form 1092, to build the week's menu (fig. 7-9). The menu planner has room for listing each menu item in a meal and has a column for the AFRS numbers to eliminate guesswork on the kind of food, the method of preparation, and the essential breakout data. Use standard abbreviations to achieve coordination between the jack-of-the-dust (or subsistence storeroom storekeeper) and galley personnel; for example, (f) for frozen, (cn) for canned,

(dehy) for dehydrated, and (inst) for instant foods. Certain standard menu items, such as coffee, are printed on the draft to facilitate drafting.

The following steps illustrate the proper sequence in drafting major meal components:

Step 1—Main dishes, gravies, sauces, and accompaniments

Step 2—Potatoes, potato substitutes, and vegetables

Step 3—Salads

Step 4—Breakfast fruits and cereals

Step 5—Desserts

Step 6—Breads and breakfast pastries

Step 7—Soups and beverages

Accompaniments to menu items should be written alongside them, shown as follows, or may be written directly underneath them, space permitting.

<u>Breakfast</u>	<u>Lunch or Dinner</u>
Fruit or juice	Soup - crackers
Cereal - milk	Main dish - gravy or sauce
Main dishes	Potatoes
Breakfast pastry	Vegetables
Bread - butter	Salads and salad dressing
Jam - jelly	Bread
Beverages	Dessert
	Beverages

Meat, Poultry, and Fish.— Using information from the frequency chart and the spacing pattern, enter the meat, fish, or poultry entrées planned for each day on the menu draft form. Introduce variety to the menu by the recipes selected for the preparation of each meat cut or poultry entrée. For example, beef, pot roast on the frequency chart and spacing pattern, may be entered as L10-1 Ginger Pot Roast on the menu draft, and the next time this style of beef is repeated on the spacing pattern, it maybe entered as L10-2 Yankee Pot Roast on the menu draft. preplanning the entrées includes the selection of an alternative choice of meat when rabbit, fish, or liver is shown.

MONDAY		RECIPE	TUESDAY		RECIPE	WEDNESDAY	
STEP 4 ---		---	CHILLED PEAR HALVES				
ASSORTED READY-TO-EAT CEREAL			ASSORTED READY-TO-EAT CEREAL, HOT FARINA		E2	ASSORTED READY-TO-EAT CEREAL	
STEP 7 ---		---	CHILLED ORANGE JUICE		C6-2		
FRESH MILK			FRESH MILK			FRESH MILK	
STEP 1 ---		---	EGGS TO ORDER				
			FRENCH TOAST		D22		
			MAPLE SYRUP/HONEY				
			GRILLED BACON		L2-2		
			BAKED SAUSAGE PATTIES		LB9-1		
			TOAST/BUTTER				
STEP 6 ---		---	CINNAMON RAISIN ROLLS		OG7-3		
JAM	JELLY		JAM	JELLY		JAM	JELLY
COFFEE - TEA			COFFEE - TEA			COFFEE - TEA	
STEP 7 ---		---	VEGETABLE SOUP		P-7		
			SALTINES - CROUTONS		D16		
STEP 1 ---		---	ROAST TURKEY		L143		
			GINGER POT ROAST		L10-1		
			BROWN GRAVY		O16		
STEP 2 ---		---	SAVORY BREAD DRESSING		O21		
			STEAMED RICE		E5		
			GLAZED CARROTS		Q17-1		
			CORN O'BRIEN		Q27-1		
STEP 3 ---		---	SALAD BAR 1 PASTRY BAR 1				
STEP 5 ---		---	CRANBERRY SAUCE				
STEP 7 ---		---	CHILLED LEMONADE		C8		
ASSORTED BREADS			ASSORTED BREADS			ASSORTED BREADS	
BUTTER			BUTTER			BUTTER	
COFFEE - TEA - MILK - SODA			COFFEE - TEA - MILK - SODA			COFFEE - TEA - MILK - SODA	
STEP 1 ---		---	BARBECUED HAM STEAKS		L70-1		
			MEAT LOAF		L35		
			BARBECUE SAUCE		O2		
STEP 2 ---		---	FRENCH FRIED POTATOES		Q45-1		
			BUTTERED GREEN BEANS		OG-3		
			STEWED TOMATOES		Q73		
STEP 3 ---		---	SALAD BAR 1 PASTRY BAR 1				
STEP 5 ---		---	CHILLED FRUIT PUNCH		C6		
STEP 7 ---		---					
ASSORTED BREADS			ASSORTED BREADS			ASSORTED BREADS	
BUTTER			BUTTER			BUTTER	
COFFEE - TEA - MILK - SODA			COFFEE - TEA - MILK - SODA			COFFEE - TEA - MILK - SODA	

BREAKFAST

LUNCH

DINNER

Figure 7-9.—A Menu Draft, NAVSUP Form 1092.

When all entrées for the cycle have been entered on each week's draft, it is good management to review the drafts to determine the following: (1) whether the proper variety and balance are maintained, (2) if higher portion cost entrées are balanced with lower portion cost entrées, and (3) if preparation of the entrées is within the capabilities of galley personnel and equipment.

Vegetables.— Frequency charts are developed for both potatoes or potato substitutes and vegetables in conjunction with the meat frequency charts so that the items selected will complement the meat, fish, or poultry item planned for each day. Entering the potato or potato substitute and vegetables on the menu draft is the second step in menu planning. Variety of preparation of the entrée items should be introduced on the menu by the selected recipe card.

Salads and Salad Dressing.— The AFRS offers many varieties of salads and kinds of salad dressings, as well as recipes for relishes. These numerous recipes are a fine foundation for a varied bar of consistently high quality. An array of salads and relishes can be prepared from the excellent variety of fresh, frozen, and canned fruits and vegetables available.

When you are selecting salads for the menu, planning is needed to achieve variety and to avoid costly leftovers. Because the salad bar generally offers some variety, there is a temptation to offer the same assortment daily. With good planning, changes from day to day can be achieved.

When you are planning for salads and relishes, there are several factors to consider: (1) seasonal availability for procurement, (2) temperature and climate, (3) equipment and labor, and (4) combinations of salad ingredients.

Select a salad dressing suited to the salad ingredients on which it is to be used. Use tart dressings with bland-flavored salads. Consult your *Foodservice Operations*, NAVSUP P-421, for ideas.

Breakfast Fruits and Cereals.— Steaming hot cooked cereals are a welcome and warming component of a hearty breakfast in cold weather. Warmer climates and higher temperatures tend to swing the popularity pendulum toward dry, ready-to-eat cereals.

Offer a choice of fruit and juice each day to make sure a good source of vitamin C is available to the patrons. Either the fruit or the juice should be citrus or tomato. In addition, fruits can be used to introduce

variety on the menus; for example, raisins in oatmeal or rice, blueberries in pancakes, and apples in fritters.

Desserts.— Desserts should be individualized to each meal just as other menu components, taking into account the patrons' preferences and other factors influencing the menu, such as climate, cooking facilities, and the skills of the personnel.

Desserts are classified as light, medium heavy, or heavy. Plan to use the one that goes best with the rest of the meal. If the meal includes hearty salads and creamed vegetables, a light dessert, such as fruit cup or flavored gelatin, is more appropriate than a medium heavy one (puddings or ice cream and cookies) or heavy desserts (cakes and pies). Balance out the day's dessert by planning a light dessert (chilled pear halves and oatmeal drop cookies) with a heavy dinner at noon and a heavy dessert (spice cake with lemon cream icing) with a light supper. One heavy dessert daily, especially one that must be baked the same day it is to be served, is sufficient for most messes.

To ensure a variety of dessert choices in your menus, make maximum use of mixes, ice cream, prepared pie fillings, gelatin desserts, and other convenience foods.

A caution that should be observed, however, in planning desserts is avoiding a repetition of the same flavors. It is easy to miss hidden flavor repetitions when breakfast juices and dinner and supper salads contain fruit. Watch for these duplications in dessert planning.

Breads and Breakfast Pastries.— Piping hot yeast rolls and quick breads dress up a meal any day of the year. Hot breads can play an important role in balancing cold meals.

When you write a menu, be realistic. If baking facilities are limited or if inexperienced MSs have not yet fully developed their baking skills, you should limit baking items.

Soups.— The soup is one of the last items planned for a lunch or dinner menu. This sequence in menu planning is not based on the relative importance of soup to a menu, but rather on its relation to other menu items. Soups are classified as light, heavy, creamed, and chowder and, as with dessert items, are selected to balance and complement the menu. The number of times a soup is offered each day or each week should be based on the crew's acceptance of soup. If the acceptance of soup is high and you feel justified in including it on the menu at both lunch and dinner meals, plan to serve a different soup at each of these meals. Make maximum use of dehydrated soups and canned

condensed soups in order to offer a variety on the menu. Leftover soups are highly subject to contamination; consequently, they create a health hazard. Fresh soup should be prepared for each meal.

Beverages.— The beverage component of menus includes coffee or tea. Milk is very nutritious and deserves a permanent place on the menu. It can be served chilled plain, or flavored, or in hot cocoa as a cold weather beverage. Coffee and tea are not necessary for good health and offering another choice for either beverage is acceptable, such as good quality drinking water.

Iced beverages added to the menu during warm weather are refreshing and provide an enjoyable change from the steady consumption of hot coffee or tea during the winter months. All iced fruit beverages in the AFRS contribute additional vitamins and minerals, as well as energy from the sugar they contain. Avoid overuse of the same juices or fruit beverages on the weekly menus. Milk shake machines and carbonated soda dispensers may be used in the mess also.

RECORDING THE MENU.— The Menu Draft, NAVSUP Form 1092, should be carefully checked and edited for accurate recipe numbers as well as for correct recipe titles and should then be presented to the food service officer for analysis. The food service officer analyzes the menu to make sure it is nutritionally balanced and reflects sound management with respect to personnel, food supplies, and food preparation equipment. The NAVSUP Form 1092 should be returned to the leading MS (approved or with noted changes) for typing on the GM Menu, NAVSUP Form 1080. NAVSUP Form 1092 should be retained for use in preparing recipe number lists and instructions on the daily Food-Preparation Worksheet, NAVSUP Form 1090.

When you use the NAVSUP Form 1090, recipe numbers should be eliminated from the NAVSUP Form 1080.

The NAVSUP Form 1080 is signed by the leading MS in the Prepared By block, by the food service officer in the first Approved block and then submitted to the commanding officer or the designated representative for approval and signature in the second Approved block. Menus may be submitted for command approval each week or the cycle menu maybe submitted in its entirety quarterly, seasonally, or when a new cycle menu is prepared.

PLAN SPECIAL MENUS

Meals have three roles in Navy life: (1) to support physical health and fitness, (2) to build morale, and (3) to provide an occasion for socializing.

Holiday or Special Event Menus

Special meals for holidays or special meal celebrations (in GMs either afloat or ashore) provide opportunities for festivity among the crew. A well-planned special meal adds interest and creates real enthusiasm among the MSs and crew.

PREPARATION.— Creative menus may be planned using foods traditionally associated with the holiday. Research through the AFRS and the *Navy Food Service*, NAVSUP P-476, files should supply new ideas.

Figure 7-10 is a calendar listing special occasions generally celebrated. It is included for a handy reference.

The meal patterns suggested for breakfast, lunch, and dinner may be changed for holiday or specialty meals to include some extras for the celebration. Well-planned special meals will add interest and enthusiasm among cooks and patrons. They can be as simple or elaborate as time, personnel, and cost permit.

PRINTING.— Some GMs may have fancy menus printed for their entire cycle menu or for special events or holidays. The printed menu gives a kind of flavor of its own to special meals. These menus need not be elaborate to be attractive. They can be simply produced using a graphics program on a computer or you can have them produced professionally through the supply system.

Usually if menus are to be printed professionally, they are either going to be used permanently for a cycle menu or for holiday menus repeating from year to year.

Brunch Menus

A brunch is neither breakfast nor lunch. Brunch is something of each of these meals, yet it has its own special identity. The distinguishing features of brunch are time of service and the special-occasion, leisurely atmosphere that can accompany a brunch meal. The brunch meal is usually served between breakfast and lunch time, generally on weekends and holidays.

Brunch menus need not be elaborate to be attractive and satisfying. A number of menu items maybe added to a heavy breakfast meal to make a brunch meal. These

JANUARY	<ul style="list-style-type: none"> ■ New Year's Day ■ Martin Luther King, Jr.'s Birthday 	JULY	<ul style="list-style-type: none"> ■ Independence Day ■ John Paul Jones' Birthday
FEBRUARY	<ul style="list-style-type: none"> ■ Valentine's Day ■ President's Day ■ Black History Month 	SEPTEMBER	<ul style="list-style-type: none"> ■ Labor Day ■ Hispanic Heritage Week
MARCH	<ul style="list-style-type: none"> ■ St. Patrick's Day ■ Easter Sunday (or April) ■ Navy Nutrition Month 	OCTOBER	<ul style="list-style-type: none"> ■ Columbus Day ■ Navy Birthday
MAY	<ul style="list-style-type: none"> ■ Armed Forces Day ■ Mother's Day ■ Memorial Day ■ Pan Asian American Heritage Week 	NOVEMBER	<ul style="list-style-type: none"> ■ Veteran's Day ■ Thanksgiving
JUNE	<ul style="list-style-type: none"> ■ Father's Day ■ Flag Day 	DECEMBER	<ul style="list-style-type: none"> ■ Christmas

Figure 7-10.-Calendar of special holidays and religious days.

may be extra ranging from first course to heavy entées to special types of cakes to complete the meal.

Imagination is the major key to successful brunch menus. Select luncheon entrées with staying power that combine easily and appetizingly with breakfast foods.

Above all, avoid overtaxing the cooking and serving facilities and personnel by planning menus that, for example, require too much oven space. Cooked-to-order foods are especially appropriate for brunch meals.

WARDROOM MENUS

As a senior MS assigned to a private mess you may hold the position of wardroom supervisor. Because of your knowledge and experience with foodservice and nutrition, the responsibility may rest with you to prepare

and submit a nutritionally balanced cycle menu to the mess caterer for review. The mess caterer will then review the menu and submit it to the mess president for approval.

The same factors that affect the choice of foods used for the GM menu are used by the menu planner to plan a private mess menu. The wardroom menu must also meet Navy nutritional requirements. As with the patrons of a GM, the preferences of wardroom mess members should be surveyed and considered in the menu-planning stage. The wardroom menu also should be limited to the supplies that are available. The menu should not be costly. Also there should be a moderation of high- and low-cost meals to keep the menu within the operating limits of the mess.

CHAPTER 8

BREADS AND DESSERTS

This chapter deals with basic baking terminology, ingredients, and the procedures used to produce breads and desserts. To bake a satisfactory product, you must have a thorough knowledge of these terms, ingredients, and baking procedures.

BREADS

The term *bread* has been used for centuries to describe a mixture of flour, sugar, shortening, salt, and liquid. This mixture is made into dough, then yeast is added to the mixture to make the dough rise.

Two kinds of bread are used in the general mess (GM). One kind includes yeast breads such as yeast-raised breads and rolls, sweet-dough rolls of various kinds, coffee cakes, doughnuts, pizza, and quick breads. The other kind includes products leavened by chemical leavening agents such as baking powder. Some of these products are biscuits, muffins, pancakes, cake doughnuts, quick coffee cake, and corn bread.

Bread is the most important food produced by the baker. It is prepared in greater quantities than any other baked product. High quality and excellent taste should be maintained regardless of the amount of bread baked.

YEAST-RAISED BREADS

The production of yeast-raised products, especially bread and sweet doughs, is considerably more involved than the production of other bakery products. If the ingredients are of good quality, used in specific amounts, and are properly mixed, using proper temperatures, the doughs will yield good quality products.

Ingredients

The baker must understand the functions of each basic baking and breadmaking ingredient used in bakery products. He or she should then use the ingredients properly (manner of mixing and amount used). The functions of these ingredients are explained next.

FLOUR.— Flour is a mixture of starch, protein, and other materials. The kinds of flour used are described as follows:

- General-purpose flour is a mixture of hard and soft wheat flours. It is used to make cakes, cookies, quick breads, pastries, and pies. It does not have enough gluten strength to make satisfactory yeast bread and rolls.

- Bread flour is a blend of hard wheat flours. It contains more protein than general-purpose flour and has a slight granular texture. Good quality bread and other yeast-raised products can be made only with bread flour.

- Wheat base is prepared from the wheat germ, bran, and other fragments of wheat kernels. It has a whole wheat flavor and may be combined with flour to produce whole wheat bread.

In addition to the protein, flour contains various food elements such as carbohydrates, water, minerals, vitamins, enzymes, and fat. The amount of these elements contained in the flour varies with the type, grade, and storage period of the flour.

Protein.— The two principal proteins present in wheat flour (gliadin and glutenin), when combined with moisture, form gluten that gives structure to batters and doughs. Gluten also gives the dough expansion qualities.

Carbohydrates. — Carbohydrates in flour are usually in the form of starch that absorbs water and helps give bulk to dough. Flour that is especially made for cakes and pastries is rich in carbohydrates.

Water.— Wheat flour usually contains from 9- to 15-percent moisture. Flour absorbs or loses moisture in storage, depending on the atmospheric conditions.

Minerals.— Minerals are contained in the bran coat and the germ of wheat, and most of the minerals are lost when wheat is made into white flour. These minerals are returned to flours that are enriched.

Vitamins.— To replace the food value lost in milling, vitamins and minerals such as thiamin, niacin, iron, and riboflavin are frequently added to flour. Flour treated in this manner is known as enriched flour.

Enzymes.— An enzyme is a very minute substance produced by a living plant. The mere presence of an enzyme brings about certain changes in the composition

of a material. Diastase and protease are the most important enzymes found in flour. Diastase converts starch to sugar, and the yeast acts upon the sugar to produce carbon dioxide and other fermentation products. Protease softens the gluten and, when this enzyme is lacking, the dough will not have the desired elasticity.

Fat.— Wheat flour contains approximately 1.5-percent fat. The major portion of the fat of wheat grain is removed during the milling process. Although the fat content of flour is very low, this is what causes flour to become rancid if flour is stored for long periods under warm and humid conditions.

WATER.— In many bakery products, including bread, the amount of water used is second only to the amount of flour. Water contains minerals. The amount and kind of minerals contained in the water vary from one part of the country to another. These variations affect the properties of the dough and the finished bread.

Water is necessary to form gluten from the protein of flour, thereby giving the dough its elasticity and its gas retaining property. Gluten absorbs twice its own weight of water. The amount of water used determines the consistency and the temperature of the dough after it is mixed. Water dissolves the salt and the sugar, makes it possible for the enzymes to act, and holds the yeast in suspension until it is added to the other ingredients and the fermentation begins.

SALT.— Very little salt is used in making bread, but the amount used is essential, for it performs a very important function. Without salt, fermentation in dough is too rapid, and the baked product becomes too coarse. With too much salt, the fermentation process is slowed, and the bread becomes soggy. Salt strengthens gluten and helps it to expand, improves the color of baked products, and enhances the flavor.

SUGAR.— During fermentation, part of the sugar is converted into a form that can be used as food for the yeast. Starches are converted into sugar that produces carbon dioxide gas and alcohol and that causes the dough to expand, making it softer and more flexible.

This sugar in the bread contributes to the color of the crust, the taste of the baked loaf, the toasting qualities of the bread, the texture, the moisture retaining qualities, and the nutritional value. Sugar is also a tenderizer.

All sugars do not have the same degree of sweetness, since sweetness depends upon the refining process through which the sugar has passed. Brown sugar, for example, is less highly refined than white

sugar and, therefore, is not so sweet. Brown sugar lends a pleasant taste to cooked or baked products, and syrups can be used as a substitute for regular sugar. Corn syrup, honey, or molasses improves the flavor of cookies and helps retain their moisture.

SHORTENING.— Shortening is the animal or vegetable fat that is used in baking. There are two general types of shortening—solid and liquid. The solid-type shortening is recommended for use in bread dough because it can be more thoroughly distributed through the dough. The reason for this is that it will not saturate the flour it touches. Although the liquid-type shortening can be used effectively, the dough must be well formed before the oil is added. The liquid-type shortening is mainly used in recipes that call for melted shortening, such as some cake and bread recipes.

Shortening compounds are composed of deodorized animal and vegetable fats mechanically blended to give a final product of acceptable elasticity and satisfactory baking quality. There are two types of solid shortening compounds used in the Navy GM—general-purpose shortening and bakery shortening (emulsifier-type).

General-Purpose Shortening.— General-purpose shortening is a high-grade shortening that has excellent baking qualities. General-purpose shortening should not be substituted in recipes that specify bakery-type shortening.

Bakery Shortening.— Bakery shortening or emulsifier-type shortening is hydrogenated shortening to which an emulsifying agent has been added. This gives the shortening exceptional ability to blend with other ingredients.

SALAD OILS.— Salad oils are generally used in the preparation of salad dressing and in recipes that specify oil. Oil should not be substituted for general-purpose or emulsifier-type shortening in recipes specifying those types.

BUTTER.— Butter is the fatty constituent of milk that is separated from the other milk constituents by churning. Butter is used most often as a spread, but it has many other uses in food preparation. When butter is substituted for other shortening, you should adjust your recipe. Butter contains salt, milk, and moisture so the salt, milk, and liquid in the recipe should be decreased accordingly. The fat content of butter is less than that of other shortening; therefore, more butter should be used in the recipe.

MILK.— Milk is almost a complete food. Nonfat dry milk contains all the food qualities of whole milk

except fat. In bread production, nonfat dry milk style A should be used, as this milk is designed specifically for achieving volume, flavor, and crust characteristics desirable in yeast breads. Dry milk can be added by mixing or sifting the milk and flour together, or it can be reconstituted with part of the water in the bread recipe and added to the dough. In either event, it is important that there are no lumps of milk powder in the dough.

The amount of milk used in the dough can be as high as 6-percent nonfat dry milk based on the weight of the flour. The use of more than 6-percent dry milk in the bread dough is detrimental to fermentation. Milk improves the texture, flavor, and keeping quality of bread.

EGGS.— Eggs are not used in making white bread but are used in making sweet doughs, cakes, and cookies. In baked products, eggs supply a high protein, mineral, and vitamin content. The yolks add color, the whites help bind other ingredients, and both combine to add flavor and moisture to the bread.

Fresh eggs should be removed from the refrigerator and warmed to room temperature before they are used in dough. Frozen eggs should be completely defrosted before they are added to the dough and should be well mixed. Dehydrated egg mix may be sifted with the dry ingredients in some baked products containing a high percentage of dry ingredients; the water needed to reconstitute eggs should be added to the required liquid. Reconstituted eggs should be used within 1 hour after they are reconstituted or returned to the refrigerator until they are to be used. Do not hold them overnight.

Leavening Agents

Leavening agents are gases that cause the dough to rise. The gases are produced by chemical action or introduced by the mixing process, which forces air into the dough. The common types of leavening agents are steam, air, and carbon dioxide gas. These agents are produced by yeast or baking soda or baking powder.

AIR.— Air is introduced into the dough by blending (creaming) fat and sugar together, by sifting flour, or by folding in beaten egg whites that already contain air. Steam is used to leaven eclairs and cream puffs.

YEAST.— Yeast is a microscopic, one-celled plant that, when conditions are favorable, will multiply by budding or by the division of a cell into two cells. In this process of reproduction, the yeast plant uses available food (sugars) to produce carbon dioxide gas and alcohol. This is known as fermentation.

ACTIVE DRY YEAST.— Active dry yeast should be suspended in about seven times its weight of water at 105°F to 110°F for 5 minutes before it is used. The proper temperature of the water is important, as water that is too cold or too hot will harm the yeast. Make sure the temperature of the water does not exceed 110°F. Active dry yeast does not require refrigeration, but should be stored in a dry and reasonably cool place. When properly stored, dry yeast will keep for many months.

Yeast foods, known as dough conditioners, have other more important functions than to supply food for yeast. Their major purposes are to condition the water and to assist in the proper fermentation of the dough.

Yeast foods contain three types of functional ingredients:

1. Ammonium salts to supply yeast with a supply of nitrogen for growth
2. Calcium salts to produce the correct amount of hardness in the dough water and to firm the gluten
3. An oxidizing agent to give a firmer, less sticky dough

In addition, yeast foods contain starch and salt to add bulk and make weighing easier. The use of yeast foods is often determined by the strength of the flour and the fermentation period desired. Not all flours require yeast food. When the flour requires such material, its addition produces bread of larger volume, better grain and texture, and improved loaf appearance. Too much will produce inferior bread with low volume and coarse grain.

BAKING SODA.— Baking soda acts as a leavening agent only when there is an acid present. Some of these acids are sour milk or buttermilk, molasses, brown sugar, honey, corn syrup, maple syrup, lemon juice, and vinegar. These are used for different types of quick bread. Only a limited quantity of the acid ingredients can be used for leavening purposes due to the pronounced flavor and heavy texture that baking soda and molasses or syrup give to the products. It is also difficult to determine beforehand the amount of gas that these mixtures will produce. Thus, it is difficult to obtain standard results.

BAKING POWDER.— Baking powder is a leavening agent that contains baking soda, a large amount of starch, and a material that forms an acid when it is mixed with water, thus producing a gas. There are several types of baking powder. The Navy uses a

combination-type baking powder that contains the acids sodium aluminum sulphate (S.A.S.) and orthophosphate plus sodium bicarbonate and a cornstarch filler. This type of baking powder is moderately double acting; one constituent acts in the batter, while the other does not act until it is heated in the oven. Baking powder is generally preferred over baking soda because it is more reliable.

General Breadmaking Procedures

The processes described next include not only the steps that you, the baker, perform, but also the processes that take place within the dough as a result of your action. When actually preparing bread, you should always follow the steps and procedures in the *Armed Forces Recipe Service (AFRS)*.

MIXING.— After you select and weigh or measure the necessary ingredients, the next important step is mixing. Dough may be mixed by hand, but an electric mixer or a bread-dough machine will make the job easier.

Dough Temperatures During Mixing.— Temperature has a definite influence on the function of yeast and its ability to condition a dough properly to produce a quality bread. The desired dough temperature (DDT) is obtained from the recipe card.

The temperature of the dough can be regulated by considering all the factors that will influence the temperature of the dough and then using water at a temperature that will offset the adverse temperatures. Any desired temperature of the dough when it leaves the mixer may be obtained by a rather simple calculation that first determines the friction factor (temperature rise induced by mixing) and may then be used at all times when the same mixer and the same weight of dough are used.

Determine the friction factor by competing the following steps:

1. Add the temperature of the room, the temperature of the flour, and the temperature of the water.
2. Multiply the temperature of the mixed sample dough by 3.
3. Subtract the first answer from the second answer.

For example:

Step 1. Temperature of room	75°F
Temperature of flour	73°F
Temperature of water.,	+54°F
	202°F
Step 2. Temperature of mixed dough	74°F
	x3
	222°F
Step 3	-202°F
Friction factor	20°F

Adjusting the temperature of the water used in the dough will control the temperature of the dough. To determine the desired water temperature you add the temperature of the room, the temperature of the flour, and the friction factor and subtract this total from the DDT multiplied by 3. You will then have the desired water temperature. For example:

Step 1. Temperature of room	75°F
Temperature of flour	73°F
Friction factor	+20°F
	168°F
Step 2. 80°F (DDT) x 3	240°F
	-168°F
Desired water temperature	72°F

The individual recipe will indicate the temperature of the water to be used in the mixing process. By following the procedures just discussed, and using a thermometer to assure the proper temperature of water being used, the final mixed dough temperature will be that which was desired.

Mixing Operation.— The mixing operation accomplishes two functions. First, thorough mixing distributes the ingredients evenly. Secondly, it stretches the dough until the gluten is fully developed and distributed.

In the early stages of the mixing process, water wets the flour and the dry ingredients. At this stage, the dough will be rather wet and lumpy. As the mixing progresses, the flour continues to take up liquid and the dough becomes moderately firm.

When you are using high-speed mixers, the dough will become firm after several minutes of mixing, but the dough has no stretching characteristic. As mixing continues, the dough begins to bond and becomes more elastic. The lumpiness disappears and the dough becomes more firm as the flour picks up more moisture. At this stage, the dough is rather sticky and sticks to the mixer bowl quite easily. Next, the dough becomes less

sticky and more elastic. When this happens, the back of the bowl begins to be cleared of dough and eventually becomes completely clear. At this time you should use careful judgment not to allow the mixing to progress too far or the dough will breakdown to a point where it loses elasticity and becomes sticky and runny. There is no rule governing the mixing time for dough other than the feel and appearance of the dough. When the mixing process is completed, the temperature of the dough should range between 78°F and 82°F.

FERMENTATION.— After the mixing operation, the dough is either left in the mixing bowl or placed in a dough trough to ferment.

Fermentation is the chemical change that takes place when yeast (or other leavening agent) in the bread releases carbon dioxide gas, causing the dough to rise. The fermentation period is the time that elapses between the mixing of the dough and the time the yeast is killed by the oven heat. The correct temperature for the dough during fermentation is indicated on the recipe card. A higher temperature will cause the growth of undesirable bacteria (wild yeast) and excessive acidity, which will result in a coarse-grained bread of poor flavor.

The length of the fermentation period depends on the amount of yeast used, the strength of the flour, and the temperature during fermentation. Too much yeast and higher temperatures than those designated cause the dough to rise too fast. Insufficiently fermented or conditioned dough is called “young dough” while that which has fermented too long is known as “old dough.”

PUNCHING.— Punching the dough after it rises develops the gluten and also redistributes the yeast cells. The temperature of the dough is equalized, and some of the carbon dioxide gas is forced out. Yeast dough is ready for punching when it is light and approximately double in size. To test the dough to determine if it is ready for punching, press the dough lightly with a fingertip. If the impression closes up immediately, the dough is not ready. If the impression recedes slightly, it is ready to be punched or folded. The dough should then be punched.

To punch the dough you should use both hands and punch the dough through the center, going from end to end of the dough trough. Then, use both hands to grasp one side of the dough and pull it on top, once again working from end to end of the dough trough. To punch dough in a mixing bowl, punch the center, fold sides into the center, then turn completely over. After the dough has rested for approximately 30 minutes, it should be taken from the bowl or trough to the bench for makeup.

DOUGH MAKEUP.— The dough is divided into uniform pieces of the desired weight. When you are dividing the dough by hand, cut off the dough with the dough scraper and weigh the dough on a scale. Use the scraper to add or remove dough until the desired weight is obtained. This process is referred to as scaling. In a machine-operated bakeshop, the baker scales the pieces by machine, making adjustments so that the pieces will be the desired weight.

ROUNDING THE DOUGH.— After scaling, the dough is rounded by tucking the raw edges and forming a smooth round ball. This process seals the raw edges that are left after the dough is divided.

INTERMEDIATE PROOFING.— The intermediate proofing period is a stage when the rounded piece of dough is allowed to rest between the time it is divided and rounded and the time it is formed for panning. The intermediate proofing period should be just long enough for a piece of dough to recover from being divided and rounded. The dough should be loose enough so that it can be easily molded. This requires from 12 to 15 minutes, depending on the dough and the conditions of the room.

Some of the advantages of rounding and giving the dough intermediate proof are it achieves uniform shape, facilitates panning, makes texture uniform, stretches gluten slowly, expels excess gas, and forms skin on surface of dough.

MOLDING AND PANNING.— The pieces of dough are shaped so that they can rise in the pan and form a shaped loaf of bread. Use the following steps in hand molding:

1. Place each piece of dough on the board, top side down. Use as little dusting flour as possible.
2. Press the gas out of the dough and pull lengthwise carefully, shaping the dough into an oblong loaf about the length of a finished loaf of bread.
3. Flatten the dough with your hands or with a rolling pin.
4. Shape the dough by folding in the ends to form a rectangle.
5. Fold the dough lengthwise to the center and seal by firm finger pressure.
6. Fold over the other half of the dough and press for additional seal.
7. Roll the dough to complete the sealing and molding of the loaf.

After the dough is molded into a loaf, place it in a lightly greased pan. Each loaf should be placed so that the molding seam is on the bottom, and the loaf should be long enough to reach the ends of the pan. Figure 8-1 provides an example of the molding and shaping of dough into a loaf.

PAN GREASING.— The primary purpose of lightly greasing the bread pan is to prevent the bread from sticking when it is removed. Too much grease on the pan surface can seriously affect the proofing, baking, and slicing of the bread.

PAN PROOFING.— After shaping and panning, loaves should be placed in a properly controlled room or cabinet called the proof box or proof cabinet for the final proof or pan proof. Temperature of the cabinet should be maintained at 90°F to 100°F. During pan

proofing, the action of the yeast is speeded up by the higher temperature and the gluten becomes more mellow and elastic.

To determine whether the loaf is properly proofed, touch it lightly with one fingertip and press in slightly. If the impression made by the tip of the finger remains, the loaf is proofed. If the imprint does not remain and fills out when the fingertip is removed, the loaf is still too compact and should be proofed more. Usually, 50 to 75 minutes is sufficient.

BAKING.— The final stage in bread production is to place the pans of dough in an oven that is heated to a temperature sufficient to heat the dough quickly (temperature specified on AFRS recipes) and to cause the carbon dioxide of the dough to expand, thereby greatly increasing the size of the dough. The oven

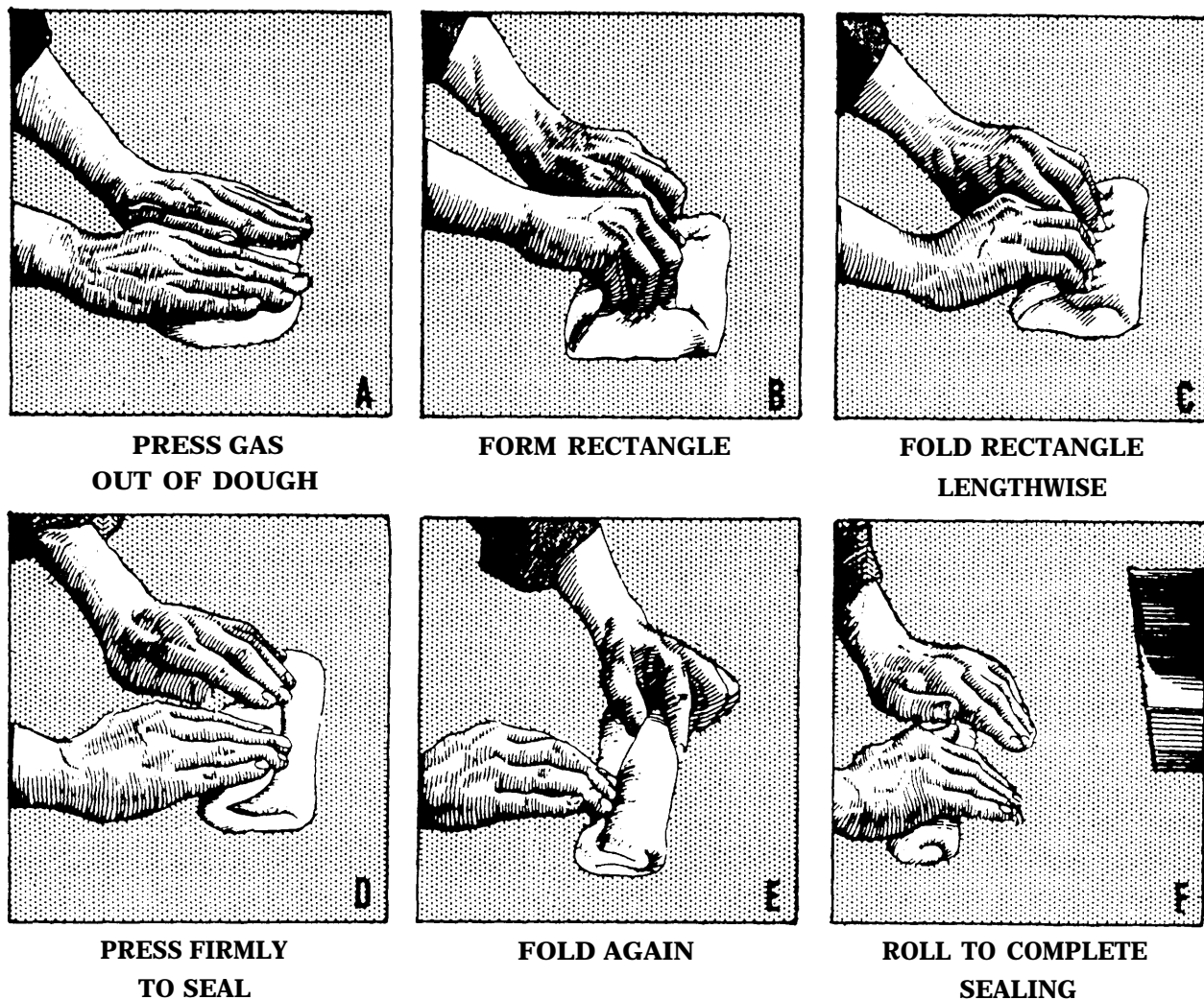

Figure 8-1.-Molding and shaping bread dough.

temperature also vaporizes moisture on the surface of the bread and ultimately causes caramelization of the sugars, starches, and other ingredients that make up the exposed dough surface. The oven temperature and the time required to bake a loaf of bread will vary, depending on several factors. When using convection ovens, follow the operating manual instructions or use the AFRS guideline card for convection ovens. Baking time is shorter and temperature is lower in a convection oven than in a conventional oven. Remember that some bread recipes will contain convection oven information as a note.

Bread is the end product of a long line of chemical and physical reactions. If the loaf is removed from the oven before these changes occur, no matter what crust color is obtained, the loaf will lack desirable qualities. Color and thickness of crust depend on the length of time the loaf is subjected to oven temperature and on the concentration of sugars. Aroma of underbaked bread is "green," lacking the full-scale, delicious fragrance characteristic of freshly baked bread. If sufficiently underbaked, the loaf sides will collapse and proper slicing is not possible.

The oven temperature may be controlled for the purpose of influencing bread character in other ways than just the color. A low oven temperature tends to open the grain of the loaf. If too high a temperature is used, the loaf may burst in a rather violent manner, usually along the sides, that results in a misshapen loaf.

A properly baked loaf of bread sounds hollow when tapped. Remove the baked loaves of bread from pans and cool on racks in areas free from drafts. Bread will dry out more quickly if the air is either too warm or too dry.

COOLING.— After the bread is done, remove the loaves from the pans and place them on racks to cool, making sure there is at least a 1-inch space between loaves. Cooling usually takes from 1 1/2 to 2 hours. Bread should not be covered while it is warm

STORING AND SERVING.— Bread should be stored at cool room temperature under conditions where it will not dry out. If wrapped in plastic bags that are closed with twisters, bread can be stored for up to 96 hours in a cool room. If the room is hot and humid, it may be necessary to store the bread under refrigeration to prevent mold from forming. Refrigeration is not ideal, however, for extended storage because bread stales more rapidly under refrigeration than it does at room temperature. This staling makes the bread firm and the crumb becomes coarse and hard. Bread may be

held for extended periods if frozen in plastic wrap or bags. If freezer storage is impractical, bread quality is best maintained by baking in quantities that will be consumed within 48 hours.

The bread storage should be arranged so that the older bread always can be used first. Sliced bread left over from a previous meal can be thoroughly dried and used for bread crumbs, bread pudding, or crouton preparation.

SHORT-TIME FORMULA.— This formula was developed to meet a critical need aboard Navy ships with limited bakery space. The short-time formula eliminates both the intermediate proof and the final loaf-molding operation. This modified sponge-type dough produces a good loaf of bread.

More importantly, ships without production equipment can produce bread within 2 to 2 1/2 hours. In addition to eliminating the 8- to 10-minute intermediate proof, the baker can roll the rounded pieces into a sausage shape and pan—one person being able to roll and pan an average of 20 per minute. Hot rolls and variations may be prepared using the short-time formula. Follow the AFRS for best results.

A room temperature of 80°F should be maintained to assure the desired finished product. Any increase in the bakeshop temperature will, of course, reduce the fermentation time. Because of the absence of fermentation rooms aboard ship, this control is strictly dependent on the baker's skill and knowledge in determining the readiness of the dough. Mixing time will not change, however, as the 10-minute periods appear to be optimum for proper dough development under practically all conditions.

UNDESIRABLE CONDITIONS.— Certain undesirable conditions may develop in the baking and storing of bread that will not only spoil individual loaves and batches but will infest the bakery and continue to destroy subsequent bakings. Sanitary precautions against these conditions are particularly necessary in hot, humid climates.

Rope.— Rope is an undesirable condition of bread caused by bacteria. The crumb of the loaf deteriorates, darkens, and becomes sticky and wet. If the loaf is pulled apart, long wet strands will appear as it separates. Rope has an odor similar to overripe cantaloupe.

The rope spores that are formed from the active rope bacteria cells are highly resistant to heat, and any that may be near the center of the loaf will not necessarily be killed by baking.

Temperatures of 86°F and above, particularly temperatures of 95°F to 105°F, promote the development of rope. When the climatic condition is such that the shop temperature is high, rope could develop even in doughs that are lower in temperature than 85°F. In the tropics, high humidity often accompanies high temperature. This increases the danger of rope developing in the bread. Also, doughs that are not sufficiently acid are highly subject to rope infection. Since acidity is normally increased through fermentation, an overly warm dough may not have time to become sufficiently acid to retard the development of rope.

When the weather or climate is hot and humid, you should keep a sharp lookout for the appearance of rope and do everything in your power to prevent its development. By controlling the temperature of the doughs, you can keep them cold enough to retard the development of rope. A mold-preventive inhibitor can be added to the bread dough. To prevent the development of rope, you should take the following precautions:

- Baking ingredients should not be kept in the shop longer than necessary, and those that are kept should be arranged in such a way as to allow free circulation of air around them.

- The bread-baking schedule should be planned so that the bakery is not overstocked; this would result in some of the bread becoming old in the shop or in the storage room.

- Bread that has accumulated and has become stale may be used for croutons and crumbs.

- All bread should be thoroughly cooled before it is stored.

- Keep equipment scrupulously clean and see that no pieces of previous doughs are allowed to remain in the shop. The shop and all equipment should be thoroughly cleaned as soon after it is used as possible.

In the event that rope does develop in your shop, it will be necessary to kill all the rope bacteria before you do any more baking. Generally, you should take the following precautions:

- Dispose of all baked products and baking ingredients in the shop.
- Thoroughly clean the shop and all the equipment.
- Wash the bulkheads, decks, and overhead with hot soapy water and rinse them thoroughly.

- Remove all foreign matter from all equipment and tools and from the cracks and seams in the oven.
- Sterilize the workbench and all small equipment.
- Rinse down everything a second time with a strong vinegar and water solution.

Mold.—Mold is composed of tiny plants that are visible to the naked eye. There are many types of mold that vary in form and color. They form velvety, colored spots on the bread and create a musty odor. Mold spores are present in the air and will become visible on most any food substance if they are given sufficient time under proper conditions to develop. Mold will multiply in a warm, humid atmosphere or on moist food. The absence of light and sufficient time also contributes to their growth. Mold first appears on the side of the loaf.

Mold is not resistant to heat; therefore, mold that may be present in baking ingredients will probably be killed during baking. This means that any mold on the baked bread is a result of improper handling of the bread after it is baked.

To prevent the formation of mold in the bakeshop, take the following precautions:

- Keep the shop clean and dry.
- Assure proper circulation of air in the shop.
- Make sure all areas are lighted.
- Bake bread thoroughly and cool properly before storing it.
- Always avoid handling the bread with wet or damp hands.
- Make sure bread is not kept for any length of time, since bread molds very quickly in storage.

ROLLS

Several types of hot rolls can be made from the basic recipe in the AFRS.

The method of making rolls is the same as that used for making bread. However, less mixing is required and the dough is much softer. Careful handling of the dough will assure light, tender rolls.

To make up the rolls, take the following steps (see fig. 8-2):

1. Divide the dough into 3- or 4-pound pieces.

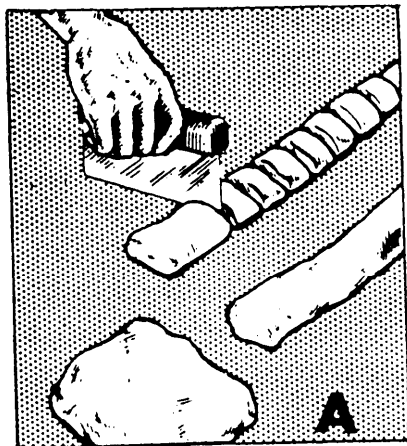

CUT STRIPS

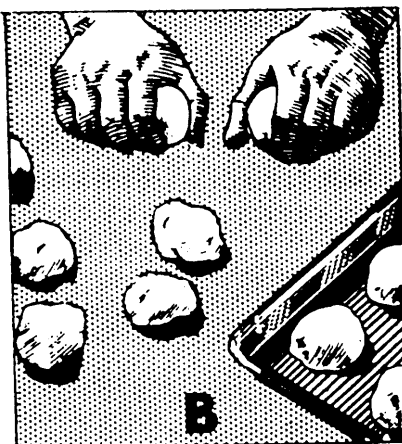

ROUND EACH PIECE



**FLATTEN ROLLS
TO DESIRED THICKNESS**



**ELONGATE
WITH ROLLING PIN**



**FOLD AND PRESS TOGETHER
INTO SMALL PIECES**



READY TO EAT

Figure 8-2.-Making rolls.

2. Roll each piece of dough into a strip 1 1/2 inches in diameter.
3. Cut each strip into pieces weighing approximately 2 ounces each (fig. 8-2, view A).
4. Round each piece into a ball by rolling it with a circular motion on the workbench (fig. 8-2, view B).
5. When you have performed these basic steps you are ready to shape the dough into sandwich rolls, Parker House rolls, wiener rolls, or dinner rolls.

Hot Roll Mix

Time-saving roll mixes have premeasured and combined ingredients except water and yeast. Follow

package and can instructions in mixing, fermentation, panning the dough, and bating.

Roll Production Precautions

The following precautions are associated with roll production:

- Like bread production, temperature control is important. The AFRS temperatures should be used. Too high a temperature will cause dough to ferment too rapidly and rolls will be sour or yeasty tasting. Too low a temperature causes heavy, tough rolls.
- The amount of fermentation time needed depends on the amount of yeast and sugar used.
- The first major step in preparing hot rolls is the dough makeup. The variety of shapes possible with soft

and hard rolls is almost endless. Accurate scaling and skilled handling in forming shapes are required. Follow AFRS guidelines for hot roll makeup.

- Since rolls are smaller than bread, proofing time is very critical. Therefore, overproofed rolls will be blistered on the surface and will fall when placed in the oven. The texture will be coarse.

Types of Rolls

Two variations of hot rolls—hard rolls and brown-and-serve rolls—can be made using the short-time formula. About 1 1/2 hours' preparation time per batch of hot rolls is saved if the short-time formula is used instead of the straight dough method. Also, a variety of sweet rolls can be made from the basic sweet dough recipe.

BROWN-AND-SERVE ROLLS.— For makeup, follow the procedure described for plain rolls for cutting and shaping. About 30 minutes (three-fourths proof) is needed for proofing. Bake at 300°F for 12 to 15 minutes or until lightly browned. Partially baked rolls may be refrigerated at 40°F up to 2 days. If freezer space is available, these rolls freeze satisfactorily up to 5 days. Finish baking at 425°F for about 12 minutes.

HARD ROLLS.— Hard rolls should have a crisp crust. Hard rolls must be thoroughly fermented or well aged because young dough produces tough, rubbery crusts. Bread flour is necessary for properly fermented or aged dough. Allow 1 1/2 hours before punching. Varieties of hard rolls include round, French, and caraway seed.

SWEET ROLLS.— A wide variety of sweet rolls can also be made from the simple basic sweet dough recipe. Sweet dough is prepared from a bread formula high in sugar, shortening, eggs, and other enriching ingredients. There are two types of sweet dough—regular sweet dough and Danish pastry. Products prepared from either of these doughs may be similar in size, shape, and weight but will differ considerably in texture. The fine, even grain and texture of regular sweet dough items are quite different from the flaky texture of the Danish pastry products. The dough should be smoother than bread dough, but it should not stick to your hands.

Among the types of sweet rolls that can be made from this basic recipe are cinnamon buns, butterfly rolls, doubleleaf rolls, pecan rolls, twists, chaintwists, braids, bear claws, crullers, snails, crescents, raisin buns, hot cross buns, plain coffee cake, small coffee cakes, and

Swedish tea rings (fig. 8-3). Specific instructions for making each of these types of sweet rolls from the basic dough recipe are given in the AFRS.

Much of the attractiveness of sweet rolls is due to the glazes and fillings used. You will find the recipes for these glazes and fillings in the AFRS—Frostings and Fillings, section D.

Sweet Dough Mix

Some GMs purchase commercial sweet dough mix that is available through the supply system.

Sweet dough mix has premeasured and combined ingredients, except for water and yeast. Follow package or can instructions in mixing, fermentation, panning, and baking the dough.

QUICK BREADS

Quick breads are bakery products in which quick-acting leavening agents such as baking powder and baking soda are used. Examples of quick breads are pancakes, muffins, and biscuits. These products require less time to mix and bake than yeast-raised products.

Soft Batters

Soft batters contain varying amounts of liquid and may be prepared in either pour batters or drop batters. Pour batters are thin enough to pour directly from a container into cooking pans. An example of a pour batter is pancake batter. Drop batters are thick enough to require spooning into baking pans. An example of a drop batter is muffins.

Roll-Out Doughs

Roll-out doughs are soft dough products such as baking powder biscuits, or stiff dough products such as cake doughnuts.

Dough or Batter Ingredients

Batters or doughs are made with dry mixtures of flour, baking powder, salt, liquids, and other ingredients such as fats, eggs, sugar, and flavoring.

FLOUR.— General-purpose flour is used for quick breads and batters. General-purpose flour produces finer grained baked products than bread flours.

LIQUIDS.— Nonfat dry milk is used in recipes for quick breads. The dry milk is sifted together with the other ingredients and the liquid is added later in mixing.

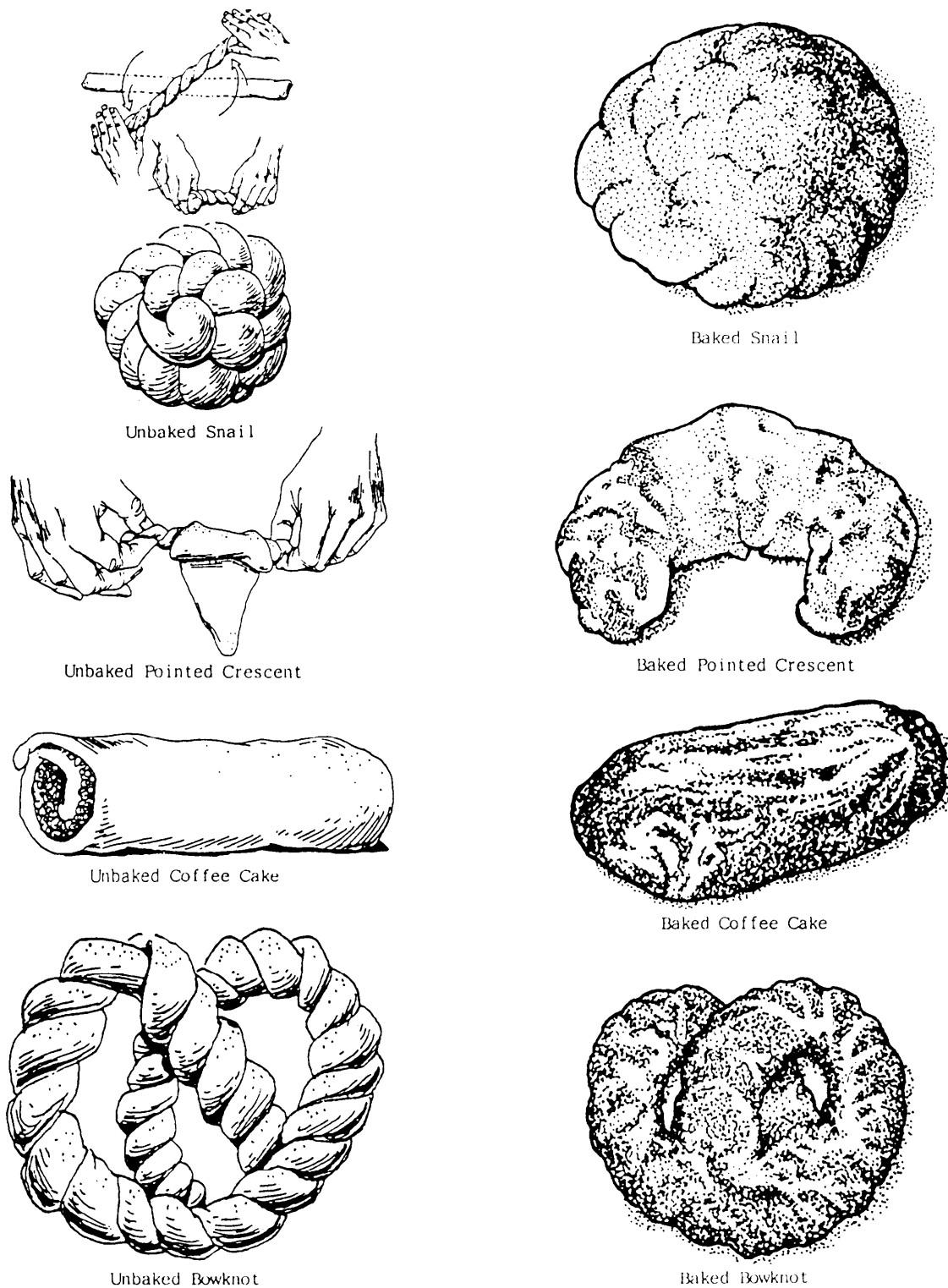

Figure 8-3.-Sample of sweet dough variations.

LEAVENING.— Baking powder is the chemical leavening agent used in AFRS quick breads. It is a double-acting baking powder in which one stage of leavening occurs in the batter and another occurs while the product is baking.

The amount of baking powder used depends on the type of bakery product, the ingredients, and their proportions. Baking powder must be measured accurately. Too much baking powder produces a coarse grain and may cause the product to fall after being taken

out of the oven. If excessive baking powder is used, the color will be dark and yellowish and the taste will be salty or bitter. Too little baking powder will result in the structure being heavy and dense with low volume.

FAT.— General-purpose shortening compound is used in quick bread and batter production. Shortenings produce products with a soft crumb and aid in browning.

EGGS.— An important ingredient in quick breads and batter is eggs, which add flavor, color, and palatability. They also provide some leavening action. Fresh whole eggs or frozen whole baking-type eggs are used. Dehydrated egg mix may be used as a successful substitute in any recipe if the eggs are sifted with the dry ingredients. This will assure even distribution and uniform reconstitution when the liquid is added.

OTHER INGREDIENTS.— Other ingredients include spices; grated, whole, or chopped fruits, nuts, poppy or caraway seeds; cereals such as bran or cornmeal; and salt. Salt adds flavor.

Mixing Methods

How ingredients are mixed determines to a large extent the structure and texture of the finished product. All ingredients should be evenly mixed. If needed, the flour gluten should be developed to the desired degree to keep the loss of the leavening gas to a minimum during baking.

These general rules apply to mixing quick breads and batters, regardless of which mixing method is chosen:

- The degree of mixing is always limited when the leavening is produced by baking powder.
- The amount of mixing varies with the kind of ingredients and their proportion, except for leavening. For example, a product containing a high percentage of fat and sugar maybe mixed longer with less harm to the quality of the finished product.
- Recipes in the AFRS outline should be followed, step by step, as the method for mixing quick bread halts.

MUFFIN-MIXING METHOD.— This method is used for pancakes, muffins, corn bread, dumplings, and fritters. The sequence of steps for the muffin method includes sifting dry ingredients together, blending in the liquid and eggs, adding melted shortening, and mixing only until dry ingredients are moistened. Corn bread, muffin, and dumpling batters should appear lumpy.

BISCUIT OR PASTRY METHOD.— This means of combining ingredients is used principally for biscuits. This dough contains more flour than liquid and is of a kneaded consistency.

The dough is prepared by sifting dry ingredients together, blending in the shortening, adding the liquid, and mixing only enough to yield a uniform structure. The dough is then cut into the desired shapes and baked.

CAKE METHOD.— Several quick breads and batters are mixed by the cake method. Cake doughnuts, coffee cakes, and muffins are mixed similarly to batter cakes. Steps used in this method are as follows:

1. Cream shortening and sugar,
2. Add eggs.
3. Gradually add the dry ingredients to the moist ingredients, alternating so that you begin and end with the dry ingredients.

Quick Bread Preparation

Both drop and pour soft batters and roll-out dough preparation methods are important to know. These batters and roll-out doughs are explained individually in the following sections.

Coffee Cakes

Coffee cakes are popular breakfast or brunch items. The recipe formulas are the same as for regular cakes eaten as desserts, except for minor ingredient changes. The major difference is in the frosting used on cakes.

Coffee cakes are either topped with sweetened crumbs or combined with fruit. Crumb cake and quick coffee cake recipes in the AFRS are of this type. Serve these cakes while still warm. Quick coffee cakes may be prepared with biscuit mix. Check the AFRS for variations.

Corn Bread

Corn bread is a quick bread popular in both northern and southern parts of the United States. Yankee-style corn bread is prepared with sugar; southern style is prepared without sugar. Jalapeno corn bread may be prepared by adding chopped jalapeno peppers.

Corn bread can be baked in either sheet pans (18 by 26 inches) or the batter may be poured into muffin pans to make muffins. Corn bread mix is available. See the AFRS recipe card for directions.

Hush Puppies

Hush puppies are small balls of corn bread batter (about 2 tablespoons) that are deep-fat fried. Finely chopped onions and black or white pepper are added to the corn bread batter. The sugar is eliminated. Corn bread mix, a complete mix except for water, is available for preparing corn bread, muffins, and hush puppies. Check the AFRS for directions.

Dumplings

There are two basic types of dumplings included in the AFRS. The first type is the meat dumpling that accompanies meat stew or poultry and is made from a dough that contains eggs and has no fat. This dumpling is light in texture and bland in flavor to accompany any meat or poultry entrée without overpowering it. This type is cooked by steam or in boiling stock. These dumplings are dropped by scoop or 1/4-cup measure on top of simmering stew. The kettle should be covered during the entire cooking period to assure fast and even doneness.

A finished dumpling should not be gummy. Dumpling quality should be the same when cooked in stock in kettles, stockpots, insert pans, or steamers. The outside of the dumpling is characteristically moist, and the inside is light and fluffy. Dumplings absorb the flavor of the accompanying meat dish.

The other type of dumpling is a filled baked dessert and is explained later in this chapter.

Fritters

A fritter is a food, such as fruit, meat, poultry, or vegetables, that has been dipped in a milk-egg-flour batter and fried in deep fat. The food maybe uncooked, cooked, or a leftover. Fritters are made by combining a vegetable, such as corn, into the basic batter. The AFRS contains recipes for apple fritters and corn fritters.

The muffin method is used for mixing fritters; that is, dry ingredients are sifted together, liquid ingredients are combined and added with melted shortening. The amount of mixing is not as critical in the production of fritter or batter mixtures as it is with other quick breads because of the high ratio of liquid to flour and the volubility of the other ingredients. There is less tendency to overdevelop the flour gluten because the ingredients mix easily. Fritters are usually very tender products because they are cooked in deep fat.

Fritters should be thoroughly drained after drying. Place the fritters on absorbent paper for a short period. Fry in small batches because fritters lose crispness if allowed to stand on a steam table.

Commercial breading and batter fry mix is a product made of ingredients similar to those used in fritter batter. Fry mix may be used for deep-fat frying, panfrying, or for grilling. Pancake mix batter may also be used for making fritters.

Tempura Batter

Tempura batter is prepared from flour, baking powder, salt, ice-cold water, and beaten eggs. The batter is unsweetened and lighter than fritter batter. It is used for dipping raw shrimp, onion rings, or a variety of other vegetables before frying. Check the AFRS for directions.

Pancakes

The muffin method is used in mixing pancakes. Mixing should be kept to a minimum to prevent the overdevelopment of the flour gluten, which causes a tough texture.

Cooking should begin as soon as the ingredients have been mixed. A hot, lightly greased griddle is essential in producing high-quality pancakes. The griddle should be maintained at 375°F. Too high or low a temperature causes uneven browning and heavy textured pancakes.

Muffins

Ingredients for muffins cover a wide range of products including fruits, nuts, bacon, and cereals in addition to the plain muffin ingredients.

Muffins are mixed using the muffin method. The mixing time is more limited for muffins than for other products mixed by this method because of the high ratio of flour to liquid. After the addition of eggs, shortening, and water, the muffin mixture should be stirred until dry ingredients are slightly moistened. It is essential that dry flour lumps be dampened. After mixing, the batter should appear quite lumpy. If overmixed, tunnels and peaks form, the product texture is tough, and the volume is low. Drained blueberries, chopped nuts, dates, or raisins are folded into the batter just before panning.

The panning procedure is an extremely important aspect in muffin preparation. The muffin pans should be well greased. Gas that causes the muffin to rise can

escape rapidly if the mixed batter is allowed to stand. Scale each muffin carefully, filling each muffin cup two-thirds full. Too much batter in muffin pans causes muffins to be coarse. A well-prepared muffin has a uniform texture, even grain, and a well-rounded but uniform top crust. A muffin mix is available. Prepare it according to instructions on the container.

Baking Powder Biscuits

Baking powder biscuits are prepared from flour, liquid, shortening, salt, and a leavening agent. When mixing, the shortening should be cut in thoroughly until the mixture resembles cornmeal.

The proportion of liquid to dry ingredients is extremely important in the production of biscuit dough. The dough should be soft, not dry or stiff, and slightly sticky. Gradually add water until dough is formed. The condition of the flour, moisture in the bake shop, and the speed of mixing can alter the amount of liquid used. When to stop adding liquid will be recognized as experience is gained in the production of biscuits.

BISCUIT MIX.— Biscuit mix is also used and contains all the ingredients except water. The leavening agent is packaged separately from the other ingredients. It should be thoroughly blended with the mix before blending in the required water. Follow directions for baking listed on the container.

BISCUIT VARIATIONS.— Biscuit variations may be prepared by rolling the dough in a rectangular shape, spreading the dough with butter, and adding brown sugar and nuts or a granulated sugar-cinnamon-raisin filling. The biscuit dough is rolled up like a jelly roll and the biscuits are then sliced. Cheddar or American cheese that has been grated maybe added to the dry ingredients to make cheese biscuits.

Cutting and Panning

Biscuit cutters used are 2 1/2 inches in diameter. Dip cutters in flour and tap lightly to remove the excess flour before cutting out the biscuits. Cut the biscuits so that rounds do not overlap.

Biscuit dough also may be patted on baking sheets and cut with a sharp knife in squares to speed up production and to save rerolling of dough. If little space is left between each biscuit on the pan, less crust is formed. If more crust is wanted, place biscuits farther apart. Baking powder biscuits should be baked at the temperature listed in the AFRS. They are best when served piping hot.

YEAST-RAISED DOUGHNUTS

The doughnut formula is basically a sweet dough; however, leavening and eggs are decreased and a combination of bread and general-purpose flours is used. A blend of general-purpose and bread flours produces a more tender texture and a shorter fermentation time than if all bread flour is used.

Doughnut formulas contain different percentages of sugar, shortening, and eggs; the greater amount used, the richer the dough. However, variations in richness for yeast-raised doughnuts do not extend over as wide a possible range as with cake doughnut formulas that tolerate larger quantities of sugar and eggs.

The sugar content in yeast-raised doughnuts controls, to some extent, the amount of browning and fat absorption during frying.

The quality of ingredients is just as important in doughnut production as it is in other yeast-raised items. Extreme care in mixing, fermentation, and makeup is essential to high-quality doughnut production.

Mixing

Mixing temperature should be controlled so that the dough leaves the mixer at 78°F to 82°F. The temperature of ingredients when mixed has a definite effect on the amount of fat absorbed during frying. Mixing time should be limited to 10 minutes or until the dough is smooth and elastic.

Fermentation and Makeup

Mixed doughs should be immediately divided into uniform pieces, the size of which depends on the weight of the entire batch being made up. Follow recipe instructions for rolling and cutting, as thickness of dough and uniformity of doughnut size are extremely important to proper frying. If there are cracks in the dough, or if it is stretched unnecessarily, the dough will tend to absorb a greater amount of fat during frying.

CUTTING.— Doughnut cutters should be used carefully to prevent overlapping the cuts and wasting the dough. Reworked and rerolled dough can be used, but will not give cut doughnuts a smooth surface or an even brown color.

Doughnuts may be cut into various shapes. Other than the characteristic round shape without centers, there are long johns, crullers, and beignets.

Yeast-raised doughnuts are neither dispensed from a machine into frying fat nor mechanically cut because they require a short proofing period.

FRYING.— Recommended temperature of the fat is 375°F for raised doughnuts. Make certain the correct temperature is used because doughnuts will soak up fat that is too cool and will brown before they are done if fat is too hot. To allow for expansion of dough and turning room, place cut doughnuts carefully in fry baskets one-half inch apart and lower into hot fat.

Normal fat absorption should be 2 to 3 ounces per dozen. This absorption is both desirable and necessary to create high-quality products. Grease soaking is undesirable, however, and is caused principally by undermining of dough, misshapen cuts and rough surfaces, and poor-quality fat used in the frying process. A fat-soaked doughnut is heavy, greasy tasting, and stales very rapidly.

Doughnuts removed from the fat should be thoroughly drained on racks or absorbent paper and cooled to 160°F if glazed. If topped with coatings, doughnuts should be cooled to 72°F (room temperature).

FILLINGS AND FINISHES

Fillings made from fruits such as cherries, pineapple, and prunes, almond paste, cream fillings, or sugar and spice mixtures may be used to fill coffee cakes, sweet dough, and Danish pastry. Most everyone prefers a coating or finish of one type or another on sweet rolls, coffee cakes, doughnuts, and other pastries. An endless combination of ingredients can be used for this purpose. The following are the most commonly used combinations:

- Dry coatings such as cinnamon-sugar filling, powdered sugar, or granulated sugar
- Glazes such as vanilla or butterscotch for doughnuts and syrup or syrup-fruit glazes for sweet rolls and coffee cakes
- Washes for breads, rolls, and coffee cakes
- Toppings

Dry Coatings

The dry coatings are used most often on cake doughnuts. Using dry sugar coatings is somewhat more complicated than merely shaking together a properly cooled fried cake doughnut and sugar in a paper bag.

Sugar coating will shed off rapidly from an overcooked, dry doughnut. On the other hand, a sugared doughnut appearing moist on the surface may be an undercooked doughnut. If the sugar melts or disappears, the doughnut is too moist. This condition is known in the baking industry as sweating. Follow the AFRS for preparing cake doughnuts. Cake doughnuts should be cooled before being sugared.

Glazes

A vanilla glaze is usually applied to yeast-raised doughnuts, but cake doughnuts also may be glazed. Other glazes incorporating imitation maple, rum, brandy, cherry, almond, and black walnut flavoring may be used.

Doughnut glazing is somewhat more complicated than the sugaring process because the glaze is much less stable, particularly at warm temperatures. Glazes should be sufficiently thin to flow and to allow the excess to roll off.

Yeast doughnuts should not be less than 160°F when glaze is applied. Taken from 375°F deep fat, a doughnut will cool to the proper temperature in about 1 to 2 minutes. Doughnuts should be submerged into the glaze and drained on a wire screen until the glaze is set. Air circulation around the entire doughnut is important in setting the glaze.

Syrup glazes are usually applied to rolls or coffee cakes. A syrup glaze is prepared from a mixture of blended syrup and water that is boiled for 5 minutes. For variation, a fruit juice or pureed fruit, sugar, and syrup mixture can be prepared. Brush syrup glazes over hot baked coffee cakes and sweet rolls.

Washes

Washes are applied to sweet doughs before baking and are used in addition to glazes or toppings in many products. They are used also on pastry, some quick breads, yeast bread (rolls and buns), and bar cookies.

Washes serve two functions: (1) to wash off excess flour and facilitate browning and (2) to provide a surface to help added toppings such as nuts, fruits, poppy or sesame seeds, or onions stick to the products. Any one of the following ingredients maybe used individual y or in combination: butter, cornstarch, whole eggs, and egg whites.

Toppings

Toppings such as glazed nut, orange coconut, raisin, streusel, pecan, or praline toppings are added to sweet rolls or coffee cakes before baking.

PIZZA

Almost any lean dough formula, such as that for French bread, can be used for making pizza. The major difference between a particular formula for pizza and lean bread doughs is that the yeast is not fed. That is, sugar is not an ingredient in a pizza formula because it is not needed to supply the yeast energy. Volume is not a factor in pizza doughs. Fermentation for pizza is relatively short in comparison with other bread doughs and makeup consists only of flattening the dough to the required dimensions.

Partially baked pizza crusts are prepared commercially and frozen. Add galley-prepared pizza sauce and bake according to package directions.

DESSERTS

Desserts are popular in the GM. A dessert maybe as simple as a fruit gelatin or as elaborate as a decorated cake. The AFRS has a wide variety of recipes for all types of desserts. The AFRS also has step-by-step procedures for the preparation and service of desserts, but the end result is often determined by the dedication and experience of the Mess Management Specialist (MS) that prepares the dessert.

CAKES

Cakes are popular desserts in the GM. A wide variety of colors from a few basic recipes are possible through the use of varied shapes, frostings, or fillings. Cakes are easily made in large quantities and they are less perishable than many other types of desserts. Service in the GM is greatly facilitated by the use of cakes for dessert because they can be made up ahead of time.

Types

Cakes can be divided into three separate types according to the ingredients and the proportions of the ingredients used in each. The three types are batter cakes, foam cakes, and chiffon cakes.

BATTER CAKES.— Batter cakes contain shortening. They include the pound cakes (loaf type)

containing a high percentage of fat, the plain cakes (basic type of layer) containing smaller percentages of fat, and the chocolate cakes (incorporating cocoa and soda) such as devil's food and mild chocolate cakes.

FOAM CAKES.— Two kinds of foam cakes served in the GM are angel food and sponge cakes. Angel food cakes are foam cakes that are leavened by air beaten into the egg white. Cream of tartar is added to the egg whites to make them firmer when they are beaten.

Sponge cakes are foam cakes containing baking powder and whole eggs. The eggs are combined with the sugar and heated until the mixture is lukewarm (110°F), and then the mixture is beaten.

CHIFFON CAKES.— Chiffon cakes contain both foam and batter, mixed separately and folded to a mixture.

The subdivisions of the three types are many and dependent upon the method of incorporating the ingredients and upon the variation of ingredients added to the basic recipe. Batter and sponge-type cakes are the ones normally prepared in Navy dining facilities; consequently, further discussion will relate only to these.

Functions of Cake Ingredients

Each ingredient in a basic recipe has a specific function.

Flour furnishes structure and is used to hold the other materials together in making a cake. It should be a general-purpose flour.

Sugars, used chiefly as sweeteners, have a tenderizing effect resulting from their ability to soften flour protein and starches. By lowering the caramelization point of the batter, sugars allow the cake crust to color at a lower temperature. Sugars also help to retain moisture in the baked cake, thereby keeping the cake moist and edible for several days.

Shortening carries the air that is incorporated in the finished cake batter. This air has a tenderizing action on the cake by virtue of its leavening action. Thus, shortening is considered to be a tenderizing agent.

Eggs furnish structure, moisture, flavor, and color. Egg whites for whipping must be free from grease or traces of egg yoke—as little as one-tenth of 1 percent will adversely affect the whipping quality.

Milk, water, fruit juice, or coffee can be used as the liquid in cake. Liquid is needed to combine and actuate

all other ingredients. It controls the consistency of the finished cake batter.

Salt brings out the flavor of the other ingredients.

Leavening is accomplished in three ways: (1) incorporation of air during mixing, (2) chemical leavening, and (3) vaporization of the liquids in the dough by the heat of the oven.

Cake Mixes

Cake mixes are convenient to use as they require shorter preparation time, less storage space, no refrigeration, and less training and experience to prepare successfully than cakes made from recipes using the basic ingredients. Cake mixes are available in a variety of flavors and preparation instructions are printed on the containers. Cake mixes are complete mixes that require only the addition of water. They contain a leavening agent, bicarbonate of soda (baking soda), packed separately inside the container. The soda packet should be mixed thoroughly with the dry ingredients before adding water. Cheesecake mix is combined with milk before mixing. No baking is required. Recipes for variation to cake mixes are given in the AFRS.

Cake Making

In addition to the proper selection of ingredients, accurate measuring, and proper mixing, other factors influence the finished product.

CAKE PANS.— Cake pans should be handled carefully so they do not warp or bend. You should not use pans that are bent out of shape because cakes will be uneven in shape and color. Cake pans may be greased or greased and dusted with flour, or they may be lined with wax or kraft paper. Some recipes call for a pan coating made from shortening and flour mixed together. Pans for angel food cake should not be greased because the fat will keep the cake from rising. Each AFRS cake recipe specifies which method is used.

PAN CLEANING.— If grease is allowed to build up in pans, especially in corners, it can become rancid and give a very objectionable taste. Care should be taken to clean baking pans thoroughly each time they are used.

SCALING.— Scaling too much batter or using the wrong size pan can cause the cake to fail. Follow the instructions given on the specific recipe card. The AFRS cake recipes are designed to yield the correct amount of batter for standard 18- by 26-inch sheet cake pans. Use only lightweight sheet pans. If heavier sheet

pans are used, they will cause overdone products. Other pan sizes may be used such as 9-inch layer pans or 16-inch square sheet pans. A listing of pans and sizes is found on the AFRS guideline cards.

OVEN TEMPERATURES.— Set the oven at the temperature specified in the recipe or in the cake mix directions and allow enough time for it to reach the correct temperature so that the cake can be placed in the oven at the specified baking temperature as soon as it is mixed. The oven thermostat should be checked from time to time to make sure it is working properly.

Allow space in the oven between the pans so that heat can circulate. Cake pans should be placed so that they do not touch each other or the sides of the oven.

If the oven is too hot, the cake will have a peaked, cracked surface and will be too brown. It will also be dry and shrink excessively. If the cake is baked too rapidly, the outer edges will be done while the center will be uncooked and the cake will fall when it is removed from the oven. If the temperature is too low, the cake will not rise well. The AFRS guideline cards give the cause of cake defects and failures.

BAKING.— During baking, the proteins in the flour and eggs coagulate and the starch in the flour swells and absorbs moisture, causing the cake to become firm. Baking takes place in four stages. In the first stage, the batter is fluid and rises rapidly as the leavening develops. In the second stage, the batter continues to rise and the cake becomes higher in the center than at the edges. Bubbles rise to the top, the surface begins to brown, and the batter begins to become firm on the edges. In the third stage, the cake has completed rising and it becomes firmer and browner. In the fourth stage, browning is completed and the structure is set. When you are baking in a conventional oven, do not open the oven door until baking time is almost ended or the cake may fall.

USING CONVECTION OVENS.— Baking times are shorter and cooking temperatures lower in convection ovens than in conventional ovens. The AFRS guideline cards list specific times and temperatures. Overloading convection ovens will cause cakes to bake unevenly. When operating a convection oven, you should turn off the fan when loading and unloading. To load cakes into convection ovens, you should start with the bottom rack and center the pans, taking care not to touch the heating elements. Leave 1 to 2 inches between pans so air can circulate. After you load the cakes, allow them to bake for 7 to 10 minutes

before turning on the blower. Or, if the fan has two speeds, use the lower speed.

Check the cakes in about one-half the cooking time specified in the convection oven owner's manual. If the cakes are baking too quickly (cooked around the edges, but not done in the middle), reduce the heat 15°F to 25°F and use this lower temperature for each successive load. The oven vent should be open when baking cakes. If the vent is closed, the moisture in the oven will keep the cakes from rising. A fully loaded convection oven will bake cakes more slowly than a partially loaded oven.

TESTING FOR DONENESS.— To determine if the cake is done, touch the center of the cake lightly. If an impression remains, return the cake to the oven for 3 to 5 minutes more and then retest. A toothpick or wire cake tester may be inserted into the cake. If no batter clings when it is removed, the cake is done. Batter cakes will shrink slightly from the sides of the pans when done.

COOLING.— If space is limited, cakes may be cooled, frosted, and served in the baking pan. If the cake is to be removed from the pan for icing, decorating, and service, allow it to cool for about 15 minutes or as directed in the specific recipe. Remove jelly rolls from pans while they are hot. Paper liners should be removed while the cake is still hot. If allowed to cool, the paper will cause the cake to pull apart and tear. Generally, however, for most cake items use a spatula to gently loosen the cake around the sides of the pan. Cover the cake with the bottom side of a clean pan of the same size and invert both pans. The cake should drop easily onto the clean pan. Cakes baked in loaf pans should be cooled completely in an upright position before they are removed. Cut around the sides, tilt the pan, and slide the cake out gently.

CAKE CUTTING.— To prevent breaking, cakes should be completely cooled before icing and cutting. Cakes baked in standard-size sheet pans are usually cut into 54 square pieces, 6 across and 9 down.

For other cake shapes consult the AFRS guideline cards. To cut a cake use a knife with a sharp, straight edge and a thin blade. Dip the knife in hot water before cutting and repeat as necessary to keep crumbs and frosting from clinging to the knife. Cut with a light, even motion. A loaf cake or fruitcake should be cut with a slow sawing motion. Fruitcakes cut easier if they are chilled first.

STORING CAKES.— Cover cakes with moistureproof paper and place them in a clean area with a temperature range of 75°F to 95°F where they will not

absorb odors. Cakes should be served within 1 to 2 days for best quality.

CAKE DECORATING

Cake decorating does not have to be limited to holidays and special events, such as a change of command or a retirement. Some commands honor the birthdays of crew members weekly with a decorated cake. This gives the MSs frequent opportunities to practice and develop their skills at cake decorating.

The first important step in cake decorating is to have a frosting of the type and consistency required to make the desired shapes. Decorators' frosting and cream frostings are suitable. Frostings used for decorating should be stiffer than those used for spreading.

Decorating Equipment

The second important step in cake decorating is to have the equipment needed: cones, tips, tubes, and coloring.

CONES.— The cones used for cake decorating may be either pastry bags purchased to fit commercial tubes, or they may be made from paper. Paper cones are easily made, are disposable, and are sanitary. The best paper used to make a cone is parchment paper. Heavy waxed paper also can be used, although it is less rigid and, therefore, more difficult to handle. Several cones can be filled with different frosting colors to be used alternatively in decoration.

TUBES.— There are many kinds and sizes of metal tubes (tips) available. They can be selected from those in standard stock or purchased to fit individual requirements. By varying the colors of the frosting and the sizes of the metal tips, a wide variety of decorations can be made. Borders can be plain or elaborate, depending on the tube used. Writing should be carefully planned before starting so it will be well centered.

An open star metal tip is used to make shell, rope, and heavier ridged borders or small flowers. Examples of various tips and the designs they make are shown in the NAVSUP P-421.

FOOD COLORINGS.— Food colorings are available in paste and liquid forms. A little coloring goes a long way. Food coloring paste will give dark shades when desired, but will not thin the frosting. Liquid colorings will thin icings and will provide only pastel shades.

To color frosting, first blend the coloring into a small amount of frosting. Then add this blend gradually to the rest of the frosting until the desired shade is obtained. Use paste shades. Dark colors, such as bright red, blue, and green, should be used only for accents and for holiday cakes.

Secondary colors may be obtained by blending primary colors:

- Blue and yellow make green.
- Yellow and red make orange.
- Red and blue make violet.

By shading violet with blue, purple is obtained; violet with red yields a reddish violet. By using red or orange, you can make red or yellow-orange by shading orange with either red or yellow. Blue-green will result when green is shaded with yellow or blue.

Try to keep icing colors as close to nature as possible by leaning toward pastels. If you must use bright colors, use them sparingly, as accents mostly, and for children's and holiday cakes. Concentrated paste colors are best to use. They give you dark shades when you want them and will not thin icings as liquids sometimes do.

Decorating Techniques

The NAVSUP P-421 extensively describes decorating techniques, examples of various decorator designs, and includes exercises devised to give you practice.

Frostings

Frostings add to the appearance and flavor of cakes and help to keep them moist. Some cakes, such as pound cake and fruitcake, are generally served without frosting, but most cakes require some kind of frosting or glaze. Jelly rolls are filled with jelly or cream filling, and powdered sugar is sprinkled on top.

FROSTING INGREDIENTS.— Ingredients used to prepare frostings include liquids, sugar, fat, flavoring, and salt.

Liquids.— Liquids make the frostings soft enough to spread. Milk water, coffee, and various fruit juices are the liquids specified in frosting recipes.

Sugar.— The kinds of sugar used to make frostings are granulated, brown, powdered (confectioner's), and blended syrup (corn and refiner's). Powdered sugar is preferable in uncooked frosting because it is fine grained

and dissolves rapidly. Blended syrup prevents the formation of large crystals that cause graininess in cooked frostings. If too much syrup is used, it will keep cooked frostings from hardening.

Fat.— Butter is the fat ingredient usually specified in the AFRS frostings.

Flavoring.— The AFRS frosting recipes specify vanilla flavoring, but other kinds of flavoring may be substituted where they would be appropriate for the flavor of the cake. Some of the flavorings available are imitation almond, banana, brandy, black walnut, cherry, lemon, maple, orange, peppermint, pineapple, and rum.

Salt.— Salt is an important ingredient in frostings because it brings out the other flavors.

UNCOOKED FROSTINGS.— Uncooked frostings are easy and quick to prepare. All ingredients should be blended at room temperature. Powdered sugar is the major ingredient in cream frostings; other basic ingredients are softened butter and liquid. The secret of a good uncooked frosting is thorough creaming until the product is light and fluffy. If frosting is too thick, add a little liquid. If too thin, add additional powdered sugar until the desired consistency is obtained. More flavoring may be required to prevent a flat sugar taste.

Decorator's frosting, a very hard uncooked frosting, is used to make decorative or special occasion cakes. It is suitable for making designs, flowers, latticework, or other forms. The decorations can be set on waxed paper to dry and then removed and placed on the cake. Because this type of frosting dries rapidly, unused portions should be covered. Royal frosting is better to use for decorating than other frostings that are softer and might run or weep.

COOKED FROSTINGS.— Temperature is very important in cooked frostings. Follow the directions given for cooked frostings in the AFRS. For best results, cakes with cooked frostings should be used on the same day they are prepared.

CAKE FROSTING PROCEDURES.— Cakes should be completely cooled, but not chilled before frosting. This prevents the cake from breaking when frosting is spread over it. Remove loose crumbs. The consistency of the frosting should be such that it spreads easily, but is not so thin that it runs off. The cake should be frosted far enough ahead of time (an hour or more) to allow the frosting to set before it is served.

To frost a cake, space six equal portions of frosting evenly over the center of the cake. Using a spatula,

spread the frosting to the same thickness across the top and to the edges of the cake. The AFRS has guidelines for preparing frosting and for frosting all types of cakes.

TOPPINGS, GLAZES, AND FILLINGS.— Toppings, glazes, and fillings, or a combination of these, can enhance the flavor, texture, and appearance of cakes. Some cakes are identified by the toppings or glazes. Pineapple, or other fruit, combined with brown sugar and melted butter and covered with yellow cake batter makes upside-down cakes. Shortcake are made by serving fruit and whipped topping with plain cake. Gingerbread is usually served with whipped topping or lemon sauce. Boston cream pie is a cake with a cream filling and covered with chocolate glaze. To make jelly rolls, sponge cake is spread with jelly, rolled, and cut in slices. Vanilla glaze topping may be spread over angel food cakes or drizzled over bundt-type cakes such as chocolate macaroon cake. Ice-cream toppings and powdered sugar may be served with pound cakes for variation.

COOKIES

Cookies are a popular dessert. Unlike most other desserts they can be stored for a day or more and used as they are needed. The various types of cookies are defined by the special processes used in making them. These types and processes are described in the following paragraphs. General directions for successful cookie making are summarized.

Types of Cookies

Cookies are often referred to as small sweet cakes and classified by the method of mixing: stiff dough, soft dough, and refrigerated dough. Recipes for the three classes of cookies are contained in the AFRS. The following types of dough are used in the production of cookies: soft dough is used for drop cookies; stiff dough is formed into a roll and baked on sheet pans; and refrigerated dough is formed into a roll, wrapped, and refrigerated until sliced and baked.

Cookies are formulated much like cake, except that there is less liquid (eggs and milk) and the baked cookies are characterized by soft, hard, brittle, or chewy textures.

SOFT DOUGH.— Soft-batter cookies have a high moisture content and, therefore, require a greater percentage of eggs to give them structure. The desired finished product is soft and moist and should be stored or packaged in a container with a tight-fitting cover.

Cookies included in this category are dropped cookies of all sorts and brownies (butterscotch and chocolate).

STIFF DOUGH.— Formulas of stiff dough contain less liquid and eggs and more flour than soft cookies. These cookies are often referred to as sliced or rolled cookies. The desirable finished product is crisp. When humidity becomes excessive, the cookies become moist and tend to soften up and lose their desirable crispness. Examples are peanut butter cookies and sugar cookies. Crisp cookies should be stored in a container with a loose-fitting cover.

REFRIGERATOR DOUGH.— Refrigerator cookies are mixed in the same manner as other cookies, except the dough is very stiff. The resulting cookie is very brittle. After the mixing is completed, the dough is weighed into pieces of convenient size. The dough is then formed into rolls, then they are sliced into the desired slices, wrapped in wax paper, and put into the refrigerator until time to bake them. The advantage of this type of cookie is that it can be made and stored in the refrigerator until it is needed, thus eliminating waste and providing a ready source of dessert at short notice. Butternut and chocolate refrigerator cookies are good examples.

Mixing Methods

Cookies are mixed in much the same manner as batter cakes. The temperature of the ingredients should be approximately 70°F. The dough is sometimes chilled later to facilitate shaping.

Cookie doughs should be mixed just enough to blend the ingredients thoroughly. Overmixing develops the gluten in the dough, thereby retarding the spread. When the mix is overcreamed, the cookies will not spread as much because of the dissolving of the sugar crystals. Improper mixing of ingredients will produce cookies that are spotted.

The conventional or creaming method is the most commonly used method. The longer the shortening and sugar are creamed, the less spread the final product will have because the sugar will be more finely distributed throughout the mix. The longer the dough is mixed after blending the flour and water, the more developed the structure of the mix will become and less spread will result. Undercreaming will give the cookies a coarse structure and will result in a baked product that has too much spread. If lumps of sugar are left in the dough during mixing, sticking is likely to occur due to the syrup that is formed during baking. Then, the sugar becomes hard and solidifies on the pans.

Cookie Mix

For convenience in preparation, oatmeal cookie mix is authorized throughout the Navy. The mix is packaged in No. 10 cans. One can (5 pounds) of mix yields 100 cookies. Preparation is simple. The mix is combined with water and the dough may be dropped, rolled, or sliced. A variety of cookies can be prepared from the basic mix. Instructions for raisin, date, nut, chocolate chip, and applesauce variations are printed on the container.

PIES

A successful pie should have a tender crust. To make sure the piecrust is tender the proper ingredients must be used and the dough should be carefully mixed.

If properly made, the standard piecrust has outstanding characteristics. In appearance, it will be golden brown with a rough surface that appears blistered. The texture will be flaky or mealy depending upon the method used to combine the ingredients. It should be tender enough to cut easily, but not so tender that it breaks or crumbles. The flavor should be delicate and pleasing.

Piecrust Ingredients

Piecrusts are made from flour, shortening, water, and salt.

FLOUR.— General-purpose flour should be used to make piecrust as it produces pie dough that is easy to handle and pan. Do not use bread flour. It will cause tough pastry.

SHORTENING.— General-purpose shortening compound should be used as it makes the crust flaky and tender. Rancid shortening or shortening that has absorbed other odors causes off-flavors in piecrust and should never be used. The shortening should be approximately 60°F when ready for mixing and just soft enough to blend with the other ingredients. At 60°F, the shortening blends well into the flour while giving firmness so that a flaky piecrust is produced. Bakery emulsifier shortening, melted shortening, or salad oil should not be used as they will cause the dough to be oily and hard to handle and will not produce flaky piecrusts.

WATER— The quantity of water and the method of mixing it with the other ingredients are the most important factors in making a tender piecrust. The water should be cold (40°F to 50°F). The amount of water

should be sufficient to make a dough that forms a ball that does not crumble, but also is not sticky when rolled out. Too much water will cause toughness.

SALT.— Salt aids in binding the ingredients together and enhances the flavors of the other ingredients.

Mixing

The flour and shortening should be mixed together until they form very small particles and are granular in appearance. When mixing by hand, the water should be added gradually until the dough reaches the right consistency—neither sticky nor crumbly. When you are machine mixing, the water is added all at once and mixed just until the dough is made.

Rolling the Dough

Divide the mixed dough into three sections (about 5 pounds 3 ounces each) and chill for at least 1 hour. The chilled dough will be easier to handle. When you are rolling the dough, handle it as little as possible. The pastry board or workbench and rolling pin should be dusted lightly with flour to prevent the dough from sticking. Using a dough divider, cut the dough sections into 7-ounce pieces for top crusts and 7 1/2-ounce pieces for bottom crusts when making two-crust pies. For one-crust pies, 7 1/2-ounce pieces should be used.

Lightly dust each piece of dough with flour and flatten the pieces gently with the palm of the hand before rolling. Use quick strokes and roll from the center toward the edge to form a circle about 1 inch larger than the pan and about one-eighth inch thick. If the dough is stretched or forced, it will shrink back during baking. Pie dough pieces may be placed into a pie rolling machine, if available. The pie dough will be rolled out automatically into a circular shape and ready for panning. Do not grease pie pans. The dough has enough shortening to keep the crust from sticking.

Fold the circle of dough in half and place it in the pan, then unfold it to fit smoothly in the pan. Make sure to fit the dough carefully into the pan so that it is flat and air pockets cannot form between the pan and dough.

Types of Pies

The types of pies prepared in the GM are one-crust (custard type), one-crust (prebaked shell), and double-crust pies.

ONE-CRUST PIE (CUSTARD TYPE).— After you roll out the dough and place it in the pan, make an edging by forming a high-standing rim on the pie shell and fluting (fig. 8-4). Fill the pie with filling and bake according to the recipes.

ONE-CRUST PIES (PREBAKED SHELL).— After placing the dough in the pan and fluting the edges, the dough should be pricked with a fork or docked. This enables air or steam that is formed underneath the crust during baking to escape without causing the crust to puff

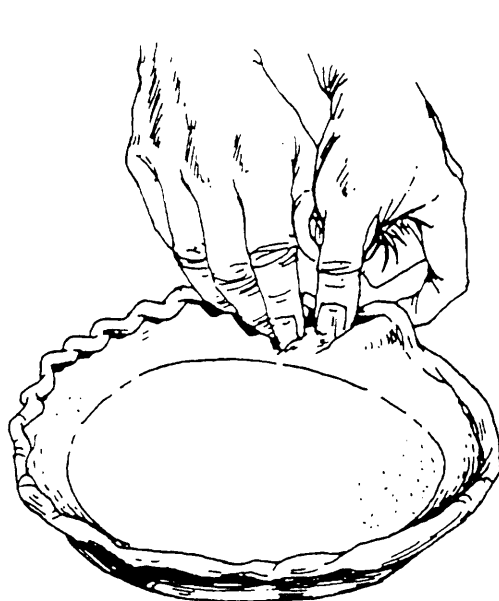

Fluted: Form a high-standing rim. Place right index finger inside rim; make flutes every 1/2-inch by pushing pastry into V with left thumb and index finger outside rim. Pinch flutes for clean edges.

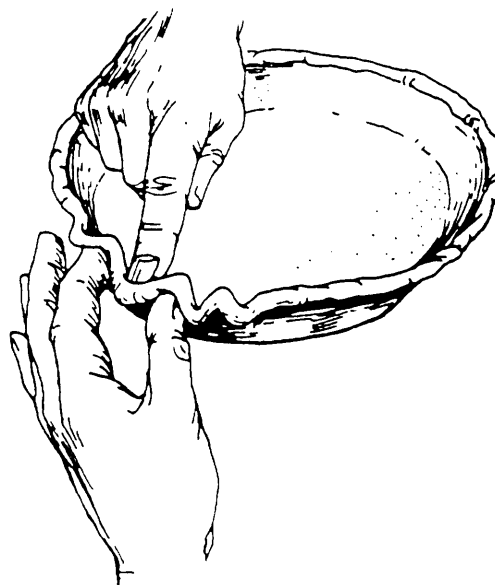

Scalloped: Form a standing rim. Place left thumb and index finger 3/4-inch apart on outside of rim. With right index finger, pull pastry to center to form scallop. (For one-crust pies only.)

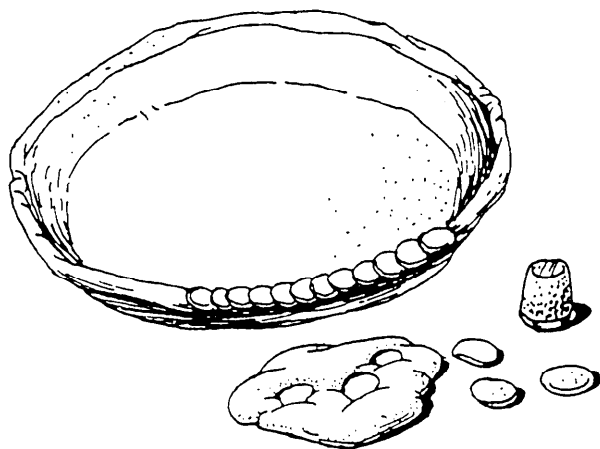

Coin: Trim pastry even with edge of pan. Cut 3/4-inch circles from rolled pastry—use center of doughnut cutter or thimble. Overlap circles on slightly moistened rim; press down lightly. (For one-crust pies only.)

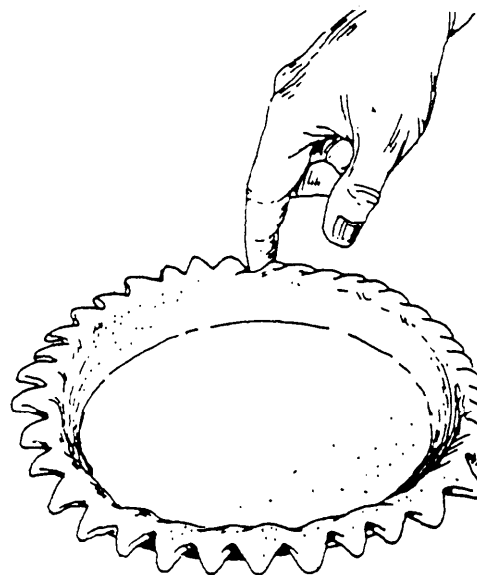

Cornucopia: Allow 1-inch additional overhang; do not turn under or make rim. With scissors, cut overhang into triangles at 1-inch intervals. Roll points in toward rim. Seal "cornucopias" on inner edge. (For one-crust pies only.)

Figure 8-4.—Making crusts for one-crust pies.

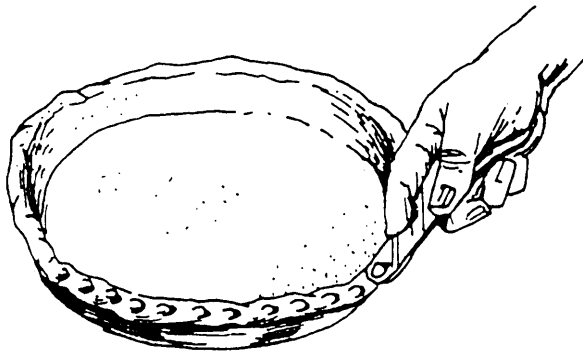

Polka Dot: Allow 1/2-inch overhang; fold under and form a rim. Press rounded end of bottle opener firmly into pastry rim. Repeat around outside rim.

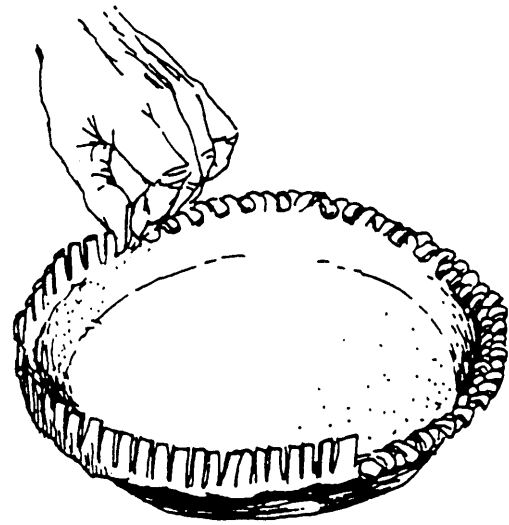

Leaf: Form a high standing rim. With scissors, clip rim at an angle every 1/4-inch. Press down clipped rim alternatively to right and left.

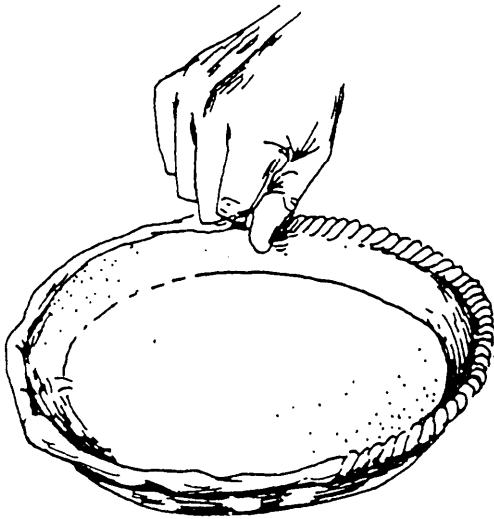

Rope: Form a standing rim. Place thumb on pastry rim at an angle; press pastry against thumb with knuckle of index finger.



Fork Scalloped: Form standing rim. Mark edges every 3/4-inch as for fluted edge. Flatten rim to edge pan between points with floured fork.

Figure 8-4. Making crusts for one-crust pies—Continued.

up or crack. After baking the shell, you should fill with the appropriate filling. Examples are coconut cream and chocolate cream pies.

DOUBLE-CRUST PIES.— The bottom crust is filled with pie filling. The piecrust rim is brushed with

water. Before placing the top crust on the filling, several small slits should be made in the top crust to allow steam to escape. The top crust should be folded in half for ease in handling, then placed on the pie filling. Unfold it carefully to prevent the crust from tearing. The edges of the piecrust are pressed lightly together. The excess

dough is then trimmed. The pie may be fluted in the same manner as one-crust pies. If a finish or glue is desired, the pie top may be sprinkled lightly with sugar or brushed with pie wash. Select the pie wash that is applicable to the type of pie being prepared.

PIECRUST VARIATIONS.— The AFRS has recipes for other piecrusts using graham crackers. Graham cracker crusts may be prepared from either crushed graham crackers, granulated sugar, and melted butter or prepared ready-to-use graham cracker crust.

Pie Fillings

Pie fillings may contain either fruit or cream. Some pie fillings are already prepared.

PREPARED PIE FILLINGS.— Prepared pie fillings are convenient to use as they require no preparation. The required amount of filling is poured into an unbaked pie shell. Apple, blueberry, cherry, and peach are the varieties available. For further information, see the AFRS cards for prepared pie fillings.

FRUIT.— Fruit fillings, except those using pregelatinized starch or canned prepared pie fillings, are cooked before being placed in an unbaked piecrust. If recipe instructions are carefully followed, the filling will be properly thickened and cut edges of the pie will ooze slightly. The pieces of fruit will look clear and distinct and the color will be bright. The AFRS gives information on ingredients used to thicken pies.

CREAM FILLINGS.— The AFRS has basic recipes for chocolate and vanilla cream pie fillings. Cream fillings should be smooth, free from lumps, and rich in appearance. The fillings should never be boiled. Boiling will cause curdling. If fruit is to be added, follow the recipe directions carefully to avoid a thin, runny filling. Follow the AFRS procedure to prevent this from occurring. Once the pie filling has been prepared, pour it into a baked piecrust and top with the desired topping.

Instant pudding mixes are available for making cream filling. They require no cooking. Available in chocolate, butterscotch, and vanilla flavors, they are designed to be prepared with nonfat dry milk and water. Chocolate mousse pie is prepared from instant pudding to which whipped topping is folded in to make a rich pie filling.

PUMPKIN.— Pumpkin pie filling is a custard-type filling to which pumpkin and spices are added. The filling is added to the unbaked crusts and baked. Note

that the pumpkin mixture for the filling should set 1 hour before adding the eggs. If not, the full amount of absorption will not take place and the filling will shrink and crack during baking.

Cream or custard fillings are highly susceptible to the formation of bacteria that cause food-borne illness. Never hold custard or cream fillings between 40°F and 140°F longer than 4 cumulative hours. Always keep cream pies refrigerated until they are served.

LEMON.— The AFRS lemon pie filling recipe specifies water rather than milk as the liquid. Lemon juice is the flavoring and should be added after the filling is cooked. If the lemon juice is added while the filling is cooking, it will prevent the mixture from thickening. Prepared, canned lemon pie filling is also available. The filling is ready to use and requires no cooking unless it is to be topped with a meringue. In that case, the pie filling should be heated to 122°F before pouring it into the baked piecrust. Dehydrated lemon pie filling mix is available. When mixed with water, it is ready for filling piecrusts. Follow manufacturer's preparation instructions.

CHIFFON.— Lemon, pineapple, and strawberry chiffon pie fillings are made easily by combining whipped topping with flavored dessert powder gelatin that has been beaten slightly after it has thickened. Well-drained fruits such as strawberries or pineapple are added. The filling is poured into a baked pie shell. Another variation of chiffon pie can be prepared by using fruit-flavored gelatin cubes of different colors mixed with whipped topping.

OTHER FILLINGS.— Pecan, mincemeat, and sweet potato pie fillings may be prepared for pie filling variations. These fillings are poured into unbaked pie shells and baked according to AFRS recipe directions.

Pie Toppings

Meringues, whipped cream, and whipped toppings are most often used as toppings to attractively garnish cream pies.

MERINGUES.— Meringues are generally used for topping cream or lemon pies. Meringues are made with egg whites, sugar, vanilla, flavoring, and salt. They must always be baked.

Dehydrated meringue powder is made from egg albumen, powdered sugar, cornstarch, flavoring, salt, phosphates, sulfates, dextrose, and stabilizers. It requires only the addition of sugar and water. Once

dehydrated, it should be spread over the filling and baked in the same method used for fresh meringue.

OTHER TOPPINGS.— Toppings for pies maybe a slice of processed American cheese or a scoop of ice cream to top apple pies. The AFRS has a large selection of frostings, fillings, and toppings.

Cutting and Serving

Pies should be cut into eight serving-size portions. Pies may be placed on individual plates for self-service from the dessert bar. Pies should be placed for service so that the point of the pie slice faces the front of the serving line. Turnovers, dumplings, fried pies, and cobblers should be served in a similar manner as pies.

Pastry

There are several types of pastries that are included in the AFRS. These are cobblers, turnovers, dumplings, and fried pies. Ready-to-use puff pastry dough, in sheets, is available. It is used with fruit fillings as a dessert. It can also be used with meat fillings and served as an entrée.

COBBLERS.— Cobblers are pies that are baked in sheet pans instead of pie pans. Cobblers maybe varied by topping the filling with pie dough cut into small dollar-sized circles or other shapes, or by using a streusel topping. Cobbler-style pies take less preparation time than the regular type of pies. Directions for preparing cobblers are provided in the AFRS.

TURNOVERS, DUMPLINGS, AND FRIED PIES.— Piecrust and fruit fillings are used according to the directions in the AFRS to make turnovers, fried pies, and dumplings. For turnovers and fried pies, the dough is rolled into a rectangle and cut into squares, then folded over and sealed. Turnovers are folded into triangles and baked. Fried pies are usually cut into semicircles and then deep-fat fried. Dessert dumplings are formed by the four points of the rectangle being pulled up to the center and then sealed. They are served warm with a dessert sauce (such as caramel).

OTHER DESSERTS

Besides cakes and pies, there are various other types of desserts used in the GM.

Fruit Desserts

Fruit-flavored gelatins, fruit crisps and crunches, baked apples, fruit cups, and fresh, canned, frozen, or dried fruit provide additional dessert variety.

FRUIT GELATIN.— Gelatin desserts are light, simple to prepare, colorful, and economical to serve. They may be plain, fruit-flavored gelatin served with a whipped topping or a gelatin and fruit mixture. Available flavors are cherry, lemon, lime, orange, raspberry, and strawberry. Follow the commercial directions on the container for the gelatin being used.

When adding fruit to gelatin, the juice drained from the fruit can be used for part of the water specified in the recipe. Using only the fruit juice will make the gelatin too sweet and may cause it to be too soft. The fruit should be well drained. Slice, dice, halve, or quarter the fruit before adding it to the slightly thickened gelatin. Fresh pineapple should be cooked before it is added to gelatin desserts as it contains an enzyme that will prevent gelatin from setting. Canned pineapple is a cooked product and, therefore, may be used without cooking.

Keep gelatin desserts refrigerated until served. Holding them on the serving line for long periods of time may cause them to melt. Gelatin desserts that are prepared in decorative molds can be unmolded easily by dipping the container in lukewarm water for a few seconds to loosen the gelatin from the bottom and sides. Individual portions can be cut with a sharp knife and a spatula used to lift out the portions for service. Gelatin desserts may be garnished with whipped toppings.

FRUIT CRISPS AND CRUNCHES.— Fruit crisps and crunches are baked fruit desserts prepared from canned or dehydrated fruits (for example, apples, peaches, pineapple, and red tart cherries). Crunches may be also made by using canned, prepared fruit pie fillings. Crisps and crunches are topped with mixtures such as buttered crumbs, oatmeal, oatmeal cookie mix, or cake mix. Cinnamon and nutmeg are added to cooked apple dessert crisps for flavor.

BAKED APPLES.— Baked apples are prepared from fresh whole, unpeeled, cooking-type apples that have been cored. A cinnamon-flavored sugar and butter syrup is poured over the top before baking. The apples may be filled with a raisin nut or raisin coconut filling if desired. Serve the baked apples warm. Whipped cream, whipped topping, or a scoop of ice cream may be added just before serving.

FRUIT CUPS.— Fresh, frozen, and canned fruits can be combined to make eye-appealing desserts. Ambrosia is a fruit cup to which coconut has been added. Seasonally available melons, such as cantaloupe, watermelon, honeydew, and honeyball melons, give extra variety to fruit cups.

FRESH, CANNED, AND FROZEN FRUIT.— Seasonally available fresh fruits and the readily available fruits such as apples, oranges, grapefruit, and bananas can complete a meal when offered as dessert. They offer an alternative to weight-conscious dining patrons who want to avoid the high-calorie desserts. Canned and frozen fruits may be served as simple desserts. Fresh pineapple may be cut into pieces and served as a dessert fruit. See the section on salads for preparation.

Custards and Puddings

Custards and puddings containing milk and eggs must not be held at temperatures between 40°F to 140°F for more than 4 cumulative hours. These desserts are extremely susceptible to rapid bacteria growth that causes food poisoning. Keep them chilled until they are served.

CREAM PUDDINGS.— Cream puddings may be prepared from the basic recipes or from instant dessert powder pudding mixes. Ready-to-serve pudding in chocolate and vanilla flavors is also available. Those products may be spooned into serving dishes or used as pie fillings in baked piecrust shells or graham cracker or cookie crusts. For information on puddings, see the section on cream pie fillings. Sliced bananas, orange sections, crushed pineapple, or coconut may be added for variations.

TAPIOCA PUDDING.— Tapioca pudding is similar to cream pudding except tapioca is used as the thickening agent instead of cornstarch. Tapioca pudding should not be heated to a boiling temperature. High heat causes the pudding to be thin and runny. Follow the AFRS directions. Garnishes, toppings, and sauces should be chosen to complement the flavor and color of the custard or pudding.

BAKED CUSTARD.— Baked custard contains milk, sugar, eggs, flavoring, and salt. It is baked until the custard is firm. The custard is done if a knife slipped into the center is clean when removed. The custard should be refrigerated until it is served.

BREAD PUDDING.— Bread puddings are economical to serve since they allow leftover bread to

be used. Because of the custard base, these puddings must be kept thoroughly chilled. Chocolate chips or coconut may be added instead of raisins.

RICE PUDDING.— The AFRS includes recipes for both baked and creamy rice puddings. Creamy rice pudding is prepared in a similar manner as cream pudding. The rice should be cooked before it is combined with the other custard ingredients. Coconut or crushed drained pineapple and chopped maraschino cherries may be substituted for raisins. Since it is a custard, rice pudding must be continuously refrigerated.

CAKE PUDDINGS.— Some cake puddings separate while baking into a layer of cake over a layer of pudding (such as chocolate cake pudding). Other types of cake puddings differ in that fruit is mixed with or placed over a cake batter before baking. Fruit cocktail pudding is an example

Cream Puffs and Eclairs

Cream puffs are round pastries that expand while baking, becoming hollow in the center. Eclairs have the same ingredients but are oblong rather than round. Cream puffs and eclairs are made by first stirring general-purpose flour into a melted butter and boiling water mixture, then cooling the mixture slightly. Unbeaten eggs are added to the mixture a few at a time and the mixture is beaten until it is stiff and shiny. Cream puffs and eclairs should be baked immediately. During the last few minutes of baking, the oven door should be opened. This will prevent them from becoming soggy and falling when removed from the oven. Cream puffs and eclairs are filled with chilled pudding, whipped cream, or ice cream. Powdered sugar may be sprinkled on top or they may be served with chocolate sauce. Cream puffs and eclairs may also be filled with tuna, shrimp, or salmon salad mixtures, or chicken a la king.

Ice Creams

Ice cream and sherbet are popular desserts. The kinds that are used in the GM are commercially prepared ice cream and sherbet and galley-prepared soft-serve ice cream and milk shakes.

COMMERCIALY PREPARED ICE CREAM AND SHERBET.— Ice cream and sherbet are available commercially in various container sizes—bulk, slices, and individual cups. Ice-cream novelties that may be procured include ice-cream bars, cones, sandwiches, and fruit-flavored ices on a stick.

SOFT-SERVE ICE CREAM AND MILK SHAKES.— Galley-prepared ice-cream mixes greatly simplify making soft-serve ice cream and milk shakes. The kinds available are dehydrated ice milk-milk shake mix, fresh liquid ice milk mix, and fresh liquid milk shake mix.

Dehydrated Ice Milk-Milk Shake Mix.— Soft-serve ice cream and milk shakes, chocolate and vanilla flavors, may be made from dehydrated ice milk-milk shake mix. The mixes are combined with 40°F to 60°F water using a wire whip. Once reconstituted, they are very perishable. Keep refrigerated until ready to use. The mixture should not contain any lumps because they will clog the freezer. After mixing, chill the mixture to 35°F to 40°F and pour it into the freezer. Do not add a warm mixture to the freezer. Start the dasher motor and then the refrigeration. Freeze the ice cream to 18°F to 22°F or until it is stiff when it is drawn off.

When preparing milk shakes, the method of preparation is the same; however, the milk shake is frozen to 27°F to 30°F.

Fresh Liquid Ice Milk Mix.— Soft-serve ice cream may be prepared from fresh liquid ice milk mix that is available from local dairy contracts. The mix is available in chocolate, vanilla, and fruit flavors. Fresh liquid ice milk mix is ready to use. No water is required.

Fresh Liquid Milk Shake Mix.— Milk shakes in chocolate and vanilla flavors may be prepared from fresh liquid milk shake mix. This mix is intended for use in milk shake mix machines, but may be prepared in a soft-serve ice-cream machine if the other is not available. A slightly slushier product will be made.

Both of the fresh, liquid mixes are perishable and should be kept chilled at all times.

For cleaning soft-serve and milk shake machines, check the manufacturer's instructions.

Yogurt

Plain and fruit-flavored yogurts are available. A vanilla or fruit-flavored yogurt mix for use with the soft-serve ice-cream machine is also available. See AFRS card for preparation instructions.

SAUCES

Some fruit sauces served with desserts such as cake, puddings, and ice cream are thickened with cornstarch or pregelatinized starch. Prepared pie fillings that are thinned with water can be used to make quick and easy fruit sauce toppings for ice cream.

Galley-prepared caramel sauce does not contain cornstarch or other thickeners. It is thickened by cooking the sauce until it reaches the soft ball stage (235°F). Chocolate sauce is prepared by combining milk with a cooked paste made of sugar, cocoa, salt, and water and then cooked. Butter and flavoring are then added. These sauces may be served over ice cream or plain cake cut into serving portions.

Vanilla sauce is served with cakes, puddings, and pastry dumplings. Cornstarch or pregelatinized starch is used for thickening. When cornstarch is used, the sauces should be cooked to thicken and to eliminate the raw starch taste.

Cherry jubilee sauce, a sauce prepared from dark sweet, pitted cherries, cornstarch, sugar imitation brandy flavoring, and water, may be prepared to serve warm over vanilla ice cream or for serving cold over vanilla pudding or plain, unfrosted yellow or white cakes.

A variety of flavorings such as imitation wild cherry, black walnut, brandy, rum, almond, orange, lemon, and banana are available for use in dessert toppings and sauces. They may be substituted for vanilla flavoring in vanilla sauce and used as specified in other recipes.

CHAPTER 9

FOODSERVICE

Excellence in foodservice is essential to the health, morale, and efficiency of all Navy personnel.

Good foodservice begins with you as the MS in the galley. The food must be properly prepared to look, taste, and smell good. It should be brought to the serving line in appropriate containers and be served in attractive portions by properly trained, neat, and clean foodservice personnel. The serving lines and all the serving operations should be arranged so foods are served at the proper temperature.

One of the most important traits that you, the MS, should have is a genuine feeling for people and a sincere service-oriented attitude. Good customer relations start with you. You should have a positive attitude toward your job and the customers you service. Attitudes have a major influence on people. A poor attitude will destroy all the hard work that has been put into the preparation and service of the meal. The key to good customer relations is to treat a customer the way you would like to be treated if you were a customer. The way you conduct yourself can make or break the meal regarding customer satisfaction.

Always remember that the MS rating is a people-oriented rating and customer service is of the utmost importance.

GENERAL MESS

General mess (GM) foodservice begins in the galley with the preparation of the food. It is equally important that food be properly served. The guidelines for attractive food presentation and serving techniques in the GM are geared to cafeteria and fast-food operations. Wardroom styles of food presentation and serving techniques are discussed later in this chapter.

APPLICABLE EQUIPMENT

Foodservice equipment used for preparing food was discussed in chapter 4. We will now address the equipment associated with serving food.

Steam Table Pans

To make sure an appetizing appearance is maintained, use shallow steam table inserts for serving both vegetables such as mashed potatoes, broccoli, and cauliflower and meat items such as breaded veal cutlets or baked pork chops. If french-fried eggplant is stacked in a deep insert, the first few customers served will receive acceptable portions; everyone else will be served a soggy portion. If the eggplant is spread loosely in a shallow insert, you will know that all the customers served will receive an appetizing, palatable portion.

Standard-sized inserts can be used to serve items such as fried chicken, baked potatoes, and macaroni. If foods require cooking in larger pans such as roasting pans or sheet pans, food items should be transferred to an awaiting insert on the serving line. Lasagna should be prepared in full-sized shallow steam table pans to prevent destroying the appearance and to increase the overall acceptability of the product. All food items should be covered to prevent shriveling or drying out. Many recipes are prepared in steam table pans thus eliminating the need for transferring the cooked food into steam table pans on the line.

Serving Utensils

Serving utensils and serving techniques go hand in hand. You cannot serve properly without the right utensils. Using the right serving tool for each dish has several advantages. It simplifies foodservice, exercises portion control, reduces food waste, and maintains a more appetizing appearance of foods in pans on the serving line.

Portion sizes appropriate for each meal is the responsibility of the galley watch captain. If the menu features two vegetables, preparation of full portions of both may result in plate waste. The portion size shown on the recipe card is a guide, not a rule. Appropriate portion sizes are shown on the food-preparation worksheet. You should periodically check excess tray waste. Portion sizes should be reduced if there is food waste. The patron who desires more will request larger portions. If the portions are hard to control, use ice-cream scoops.

Mashed potatoes, rice, bread dressings, and baked beans are easy to serve with a scoop and portions are easier to control. When you are serving bulk ice cream, scoops and dippers should be rinsed between servings or placed in potable running water. Bulk ice-cream products are not authorized for self-service.

Use a food turner for lifting steak scrambled eggs, or other similar items. For mashed potatoes or items of similar consistency, use a serving spoon or a scoop. Use a basting spoon or other shallow spoon to dip sauce or gravy from a shallow pan. Use a ladle to serve food from a deep well. Some foods, such as peas and cabbage, should be served with a perforated spoon, so the liquid drains back into the serving pan. Fried chicken, asparagus, broccoli, and corn on the cob should be handled with tongs. If more than one serving line is being used, be sure the same item is being served in the same portion on each line.

Serving Utensils for Salads

An adequate number of the proper serving utensils for the salad bar will promote good sanitary practices and keep the salad bar in order during self-service. The most useful utensils and the food with which they can be used are as follows:

- Tongs—for relishes and green salads—such as carrot sticks, celery, pickles, olives, lettuce and other salad greens
- Perforated spoons—for salads mixed with thin dressings—such as coleslaw, fruit salad, and cucumber and onion salad
- Basting spoons or scoops—for compact foods and salad mixtures—such as potato, ham, fish, cottage cheese, and macaroni salads
- Small ladles—for thick and thin salad dressings

Lighting

Foods appear more attractive under warm, natural light. Use incandescent or warm white fluorescent bulbs to give natural warm colors to the serving lines. If colored lights are used, be careful to use the correct color to achieve the desired effect. Red lights will give roast beef a warm, rare, and hearty appearance. Test the color lights needed for your particular layout. Position light correctly on the food so the customer and the server are not blinded. Lights over food also should be adequately shielded.

SERVING LINE AREAS

The serving area, which includes the salad bar, steam table, bread and pastry counter, drink or beverage dispensers, should be cleaned after each meal. This area should be checked again before each meal to make sure it is clean and sanitary.

Salad Bar

Most salad bars are self-service and refrigerated. Salad bars range from the proportioned to the make your own type. A fully stocked, large variety salad bar is very popular with patrons of the GM. Often, it offers an alternative food source for weight-conscious patrons.

ARRANGEMENT OF SALAD ITEMS.—

Overcrowding items on the salad bar detracts from the overall appearance, hinders easy self-service, slows down the service, and generates confusion. Careful attention should be given to the arrangement of the salad items to prevent the customer from having to reach over one container of food to get to another. Particles of food are often dropped from one container to another, resulting in an unappetizing, unsatisfactory display of food.

REFRIGERATION OF SALAD INGREDIENTS—

For proper refrigeration of ingredients, place all salad bar items in pans or in trays on a bed of ice, or on a mechanically refrigerated salad bar unit. Proper drainage is essential if salad items are set in ice.

When the use of ice is not possible, and the salad bar is not refrigerated, the bar should be large enough to accommodate shallow pans or trays of salad items. These trays of salad items should be kept under refrigeration until just before serving time. Because of the high room temperature of most messing areas, easily contaminated food should be placed on the salad bar in small quantities and replenished as needed. Examples of such foods are salad mixtures containing meat, fish, poultry, eggs, cooked salad dressing, and mayonnaise. Commercially prepared salad dressings in individual portions and opened bottled salad dressing should be refrigerated.

Hot Food

Hot food should be placed on the steam table just before serving time. The quantities of food placed on the serving table should be small and should be replenished frequently during the serving period. It will

be necessary to use progressive cooking techniques to meet these requirements.

If possible, arrange hot foods in the following order: soup, main entrée, sauce or gravy, potatoes or potato substitute, and vegetables. All short-order types of items for breakfast such as pancakes, ham slices, and eggs should be served from the grill on a prepared-to-order basis.

Heat and juices are lost so quickly from sliced meats, Roasts are more palatable when carved on the serving line as the customers come through because most of the natural juices and the heat will be retained. Meat carving is covered later in this chapter.

Cold Food

Keeping cold foods, such as salads, properly chilled also requires planning and preparation. Salads contribute a great deal to the meal; they add variety, make meals more attractive, and help balance the meal. Because self-service salad bars are used increasingly in the GM, this method of serving salads is covered in another section in this chapter.

Desserts and Pastries

When possible, separate the dessert bar from the serving line and place it in the center of the messing area. Using this setup, the patrons can pick up desserts after eating the main course.

Desserts should be set in a tempting arrangement. Serve cleanly cut slices of pie and evenly sliced squares of cakes and cookie bars. Puddings and other similar desserts should be spooned neatly in bowls or dishes. Most desserts should be proportioned and replenished frequently to the serving line. If a special occasion cake is prepared, set the unsliced cake on the serving line. This will allow the decorated cake to be seen before it is sliced. Slice and proportion the cake on plates as the customers approach the dessert bar. One or two whole baked pies can be set on the serving line with sliced portions of the pie.

Highly perishable desserts such as cream puddings and pies, custards, fruit gelatin desserts, cream puffs, and eclairs should be served chilled. Place them on refrigerated units or on trays over ice. Keep ice cream frozen. Whipped toppings should be served cold. Serve toppings from a small container and replenish frequently.

Locate dessert dishes for ice cream next to the ice-cream freezer. If soft ice cream is served, place

paper cones or sugar cones near the machine. Sundae toppings should be located near the ice cream. If pie a la mode is the featured dessert, add scoops of ice cream as the dining patrons select the pie. Ice-cream pies should remain frozen. Place only a few slices of ice-cream pie on the serving line and replenish as required.

When preportioning desserts, you should provide a smaller portion with the standard size for the weight-conscious patrons.

Beverages

Cold drinks and juices should not be dispensed by ladle from an insert; milk dispensers or other appropriate dispensers should be used. Do not serve juices from their original container unless the cans are the individual size. Juices may be dispensed from beverage coolers or pitchers. Proportioned juices speed service and aid in portion control and can be replenished as required.

Serving Line Arrangement

A well-arranged serving line operates quickly and smoothly. Each customer can select the food that is desired and can get the food to the table while it is still at the proper eating temperature. Some of the planning techniques used to accomplish these goals are explained next.

Careful arrangement of hot and cold foods is extremely important. Personnel should be routed to avoid delay and unnecessary congestion in serving and dining areas.

If the physical setup allows, salad bars should be stationed where the patron can stop first before approaching the hot food serving line. Eliminating the stop at the salad bar en route to the tables will enable the hot food to be eaten while still hot.

If possible, separate the dessert bar from the serving line and place it in the center of the dining area. Using this setup, the patrons can pick up desserts after eating the main course. A reduction in the number of desserts convinced and a decrease in tray waste will usually be noticed.

Place trays and bowls at the head of the serving line. Silverware should be at the end of the serving line. Cups and glasses should be placed near the beverage dispensers. GMs with false overheads, wooden paneling, brand new equipment, and a showplace galley will enhance the atmosphere. However, the key to customer satisfaction is good food, well served.

Speed Line

Equipment specifically recommended for fast-food application is labor-saving and offers an activity a modern upgrade. Yet, fast food products are easily prepared in older, unmodified galleys.

For many years ships and shore activities have had a speed line in addition to a normal cafeteria-style full serving line.

The benefits GMs gain using both a normal and a speed line are as follows:

- Reduce their waiting lines
- Provide the sailors with a more pleasant atmosphere
- Prepare highly acceptable, easily prepared food items using modern, high-production equipment

Most often, speed line items and recommended menus can be prepared and served in any GM without equipment changes or additions. An exception is when extruded french fries are to be prepared. The *Armed Forces Recipe Service AAFRS*) has recipes that can be used as speed line items.

SERVING TECHNIQUES

As a petty officer, you may be placed in charge of the serving line. When this is the case, you should instruct personnel on the proper techniques for placing items on the serving line. This should include how to serve each item and how to place the items on the plate or tray. Correct serving techniques are very important.

Merchandizing

Presenting menu items on the serving line is doing what commercial food operators call merchandizing. Successful merchandizing involves making these items so attractive and appetizing that customers want to eat them. When we present menu items on the serving line we want to stimulate the appetite and promote the welfare of the patron.

People will always eat with their eyes. So it is a good rule of thumb that foods that do not have an attractive and appealing appearance are often rejected without being tasted.

In chapter 7 we discussed the importance of planning a menu so the foods selected for a menu will have harmonious colors. Harmonious colors present an inviting appearance when placed together on the plate.

All food items in a well-planned meal should vary in color, size, shape, and texture.

Service is speeded up when a person knows what foods are being served before reaching the serving line. It is a good practice to post the current menu, in full view, near the beginning of the serving line. It may either be in the form of a typed menu or a menu board. The menu board is used to display those food items that are being served for the current meal. Actually, any display method is acceptable that gives the customers time to decide which foods they desire before they reach the serving line. A suitable means of expressing calorie content for each item in the meal should be publicized for the benefit of dieters and weight watchers.

Centerpieces can be the focal point of the serving line on holidays and special occasions. The realm of possibilities is limited only by imagination and time.

Ice, crushed, cubed, or carved, can be an interesting addition to highlight any meal. On special occasions, and when practical, ice carvings can be used as distinctive centerpieces. They can take on many forms, such as swans, baskets, rabbits, deer, and even turkeys. They may be elaborate or simple in design.

Garnishing

Though garnishing is just one step in presenting food attractively, it is a very important one. A garnish is described as an ornament or a decoration. Garnishes are planned to complement the flavor and the texture of the dish as well as add eye appeal. Any garnish used should be edible and should be such an integral part of the food that it will not be left on the plate.

If you were to plan a garnish for every food, it would be quite a job, but fortunately not all foods need this help. An example is a meal consisting of pot roast of beef, mashed potatoes, brown gravy, buttered peas, celery sticks and sweet pickles, hot rolls and butter, and blueberry pie. Such a meal needs to have nothing added in the way of a garnish to make it attractive. The natural colors, textures, and flavors combined in this meal provide enough variety to make the meal inviting to the eye and tempting to the taste.

Many of the AFRS recipes have a built-in garnish. Good examples of this are beef stew, tossed vegetable salads, browned casseroles, and desserts such as cakes iced with frostings that complement the color and flavor of the cake.

Always refer to the food-preparation worksheet for information on garnishing various foods on the menu.

The following list contains some practical guides to effective food garnishing:

- Use restraint in garnishing. Keep a picture of the whole meal in mind. Too many garnished dishes in one meal will spoil the effect. Select a suitable garnish, if one is needed, and use it sparingly.
- Vary food garnishes. Do not let garnishes become monotonous. Use a section of orange or a slice of peach on top of a pudding occasionally; not always a maraschino cherry.
- Plan garnishes ahead of time and show the serving personnel how garnished foods should be served.
- Plan simple garnishes. Do not sacrifice timely preparation for the sake of garnishing.
- Take advantage of the natural food color contrasts in combining foods. Do not rely on the addition of food coloring to the food to supply color contrast.

Carving

For special occasions such as holidays, hand carving hams and roasts on the serving line is preferred over machine slicing.

Carving plays an important role in serving meat in an appetizing manner. Carving affects the appearance and texture of the meat, and the portion size can be controlled by carving. Therefore, as an MS, you must develop skill in carving.

The direction of meat grain determines how the meat is to be sliced. Most meats should be cut across the grain. Cross-grain slicing shortens the muscle fibers and produces a more tender slice of meat. Roast meats should be allowed to rest about 20 minutes after they have been removed from the oven before they are carved. This period allows the meat to “firm up.” It also allows the meat to reabsorb some of the juices lost during the roasting process. The meat becomes firm and can be sliced with greater ease in equal slices.

Slicing should be done on a hard rubber cutting board so the cutting edge of the knife is protected. The carving board should be placed in a sheet pan to catch the drippings while the meat is being sliced. Remove any string or netting that may have been used to hold the meat together while it was cooking. With a sharp carving knife (long, thin-bladed knife) and a two-tined fork in hand, carve the roast as follows:

1. Cut one slice across the top of the roast so the Carver can determine the direction of the grain of the roast.
2. Hold the roast in place by pressing the fork firmly into the top of the roast.
3. Carve across the grain of the meat from right to left for a right-handed person and from left to right for a left-handed person. The carved portions can then be easily lifted to the plate or tray.

Sliced meat portions should be controlled by weight rather than by the number of slices. For this reason, the customer's preference for thick or thin meat slices can be satisfied by the carver.

Timing

The commanding officer sets the hours for serving the meal. The time published should be strictly adhered to; the day's work schedule in the galley should be organized to conform to the established hours for serving meals. The messdecks and serving personnel should be ready to begin serving on time. Planning will ensure prompt and efficient service.

The serving line should not be setup too early. You should set up about 45 minutes before the regular meal as a general rule. This also allows for the cooks and mess attendants to enjoy their meal.

When serving you should be alert to what needs to be replenished. Do not wait until the food item is completely depleted before replacing. Food items should not be left on the steam table line too long. Remember to batch-cook all items that can be cooked progressively. A good rule of thumb to remember is what is available for your first customer should be available for your last customer.

Foodservice Attendants

FoodService personnel should be trained to provide good customer service. Common courtesy is the backbone of good customer service. This cannot be overemphasized because the way the serving line personnel conduct themselves often determines the patrons' satisfaction or dissatisfaction with the meal.

Every person assigned to the serving line should be clean and look neat. This requires the washing of hands many times during the day. Uniforms, hats, and aprons must be clean. Long sleeves should be rolled up to avoid touching the food and equipment. Foodservice attendants not only should be clean and neat, they should

be trained to serve food properly because serving techniques also affect sanitation and attractiveness. They should be given detailed instructions on the proper serving of each menu item. To avoid possible contamination, utensils and dishes should be properly handled during serving. Servers' hands should not come in contact with eating surfaces of bowls, trays, or silverware.

Serving Line and GM Appearance

All items of mess gear should be inspected for cleanliness and should be supplied in sufficient number to last the entire serving period. The serving counters and steam tables should be checked for cleanliness before foods are set in place. Condiment bottles, including tops, should be thoroughly cleaned. During meal service, keep serving lines and salad bars wiped down. Wipe up spills immediately. Sponges and other cleaning aids should be kept out of sight. If used, sponges should be spotlessly clean. Dirty sponges detract from meal service. Return soiled empty serving inserts and containers to the galley.

SERVING THE FOOD

Soups and chowders are placed on the steam table in deep well inserts. Use the 8-ounce ladle to serve as follows (key serving points follow each step):

1. Pick up the soup ladle. Hold the ladle about halfway down the handle, grasping it between the thumb and forefinger. This firm hold makes it easier to balance a full ladle.
2. Stir the soup or chowder. Stirring distributes the solid particles and the temperature evenly.
3. Dip from the bottom. Solids settle to the bottom, and the soup or chowder at the bottom of the insert is the hottest. Dip while solid particles are in motion.
4. Raise the ladle above the level of the soup bowl. The customer in line has extended the tray and soup bowl toward you. As you raise the ladle, the liquid it contains will settle so it is easier to pour, and it will not spill over the sides.
5. Tip the ladle slightly and pour slowly. Direct the pouring into the center of the soup bowl.

Whenever you serve stew, chili con carne, or any similar item, you should use the same technique. Stir to distribute the solid particles and the liquid evenly and then dip from the bottom. This is the only time you should stir these items. When there is a lull and you are

waiting for the next person to come through the line, do not stand and idly stir the vegetables. The less they are stirred, the better they will maintain their appetizing appearance.

As you serve items that are in shallow inserts, serve the food from the back of the pan toward the front of the pan in an orderly system across the pan. Types of food that should be served this way are macaroni and cheese, baked lasagna, or Lyonnaise potatoes. A uniform way of serving helps maintain the fresh appearance of the food and promotes eye appeal.

Butter patties should be served from a dispenser. If a dispenser is not available, the ready-to-serve patties may be placed on a tray and set over a container of ice on the serving line. Unwrapped patties should be placed on paper chips and arranged on a tray set over ice.

Dry cereal also should be served from a dispenser. It should never be served directly from the packing carton. If a dispenser is not available, the individual packages should be arranged on a tray on the serving line.

Bread will remain fresher if served from dispensers. Otherwise, bread should be opened as needed, removed from the wrapper, and placed in a shallow container on the serving line. Galley-baked bread should be sliced and replenished when needed during the meal. Chilled bread should be heated before meal service. To give a fresh-baked quality to breakfast pastries, coffee cakes, and sweet rolls, heat them in an oven (250°F) for 8 to 10 minutes before serving.

Portions

The MS assigned to supervise the serving line has two responsibilities regarding portion control. One is to see that servings are fair. The other is to make sure the amount served is not more than the individual requests.

The portion size of some items can be regulated on the serving line by using standard ladles and spoons. When you serve meat, guesswork on correct portion sizes can be eliminated by using scales to check one or two slices before you cut the entire batch. Some meat items are precut in individual serving portions; for example, grill and Swiss steaks, pork slices (chops), and veal slices.

Temperature of Food

The steam table should be prepared in advance. Water has to be placed in the steam table and the steam table turned on. This will allow the water to be at a

temperature of 180°F to 200°F when food is placed on the table. This temperature should be maintained always while food is on the serving line. Temperatures below this range will not keep food hot enough. Higher temperatures will cause overcooking and ultimately ruin both the taste and the appearance of the food.

Replenishment

As the petty officer in charge of the serving line, you have the responsibility for keeping food on the serving line for the entire meal. You should make sure food is replenished in a timely manner and not allow the line to be held up.

Replenish by removing the inserts or containers and replacing them with fresh filled ones. Never dump food into inserts already on the serving line.

Empty inserts should be kept off the decks and serving lines. They should be sent to the deep sink for cleaning and sanitizing after each use. They should not be allowed to build up until the completion of the meal.

Customer Service During the Meal

Customer service does not end with the serving line. Other important customer service considerations are clean tables and chairs with adequate supplies of napkins, salt and pepper shakers, and condiments. Patrons also like peace and quiet with courteous foodservice attendants and messdeck masters-at-arms (MDMAAs).

Maintaining the Messing Area

Sanitary practices that should be followed in the preparation and in the serving of the food have been discussed. It is equally important to maintain the mess area in an orderly and sanitary manner during the meal and to clean it thoroughly after the meal.

The tabletops should always be kept scrupulously clean. They should be scrubbed and sanitized after each meal. This should be done with hot soapy water and rinsed with clear water to which a germicide solution has been added. Germicide and fungicide solutions are standard stock items and may be ordered through supply channels. The sanitizing solution should be changed as frequently as necessary to ensure a clean solution.

Securing

After each meal the salt, pepper, and condiment containers should be thoroughly wiped with a mild

detergent solution and then refilled. Once each week the salt and pepper shakers should be emptied, prewashed, and put through the dishwashing machine. These containers should be arranged in the same order on all tables. The method recommended is to place the taller containers in the center and arrange the others around them in graduated order of height.

Foodservice personnel assigned to the messing area should be instructed to check the messing area continuously during the serving period. Spilled food on the deck is a safety hazard and should be cleaned up immediately.

Dinnerware should be washed after each meal and made ready for the next meal. Before storing the clean utensils, the cabinet should be inspected for cleanliness. Trays and bowls should be at the head of the serving line; silverware may be placed at the head of the line but it is recommended that it be placed at the end of the line. Cups and glasses should be located near the beverage dispensers. All items of dinnerware should be inspected to make sure they are spotlessly clean and not chipped, cracked, or bent. An inventory should be taken once a week to be sure there is enough dinnerware to last the entire serving period.

WARDROOM MESS

Thus far, our discussions have centered primarily on the various aspects of preparing and serving the food in the GM. While this is an important part of your job, it is only one part. You have other duties. They include maintaining a clean, sanitary messing area, setting the tables for regular and formal meals for officers, and estimating the proper seating arrangements for the officers and their guests.

The wardroom is usually a multipurpose area. It is the officers' dining area and lounge. It is an area where officers gather for social functions, entertainment, to conduct business, and to hold conferences.

Usually family-style foodservice will be provided in a wardroom. However, other factors determine the type of service used in a wardroom. These factors are specific wardroom design, the number of foodservice personnel assigned, and the desires of the mess president and commanding officer. Regardless of the type used, the service should be carried out properly.

The success of a meal often depends on how it is served. Good foodservice is not easy to give and requires knowledge, training, and planning. All of this

should be accomplished before seating the wardroom members.

MEAL STYLES

There are two basic meal styles used in the wardroom—formal and informal. Variations of each style are used on particular occasions. These styles and their differences are discussed next.

Formal Service

Formal meal service includes the semiformal and the formal styles called French service.

The formal type of meal requires more planning, detailed preparation, and elaborate tableware than any of the other styles. The formal meal style is used most often when special guests or dignitaries are present either in the flag or wardroom messes.

The formal meal style of serving is when you serve the food from a food wagon, a side table, or offer it to guests from a serving dish. As many as seven courses may be served in this manner. All courses are served with the plates being removed after each course. Additionally, the place setting has no bread and butter plate.

Semiformal service is the type of service used more often than formal. For example, it may be used daily in commanding and flag officers' messes if there are no guests. The preparation and service of this meal are not as elaborate as the formal style and require less time, facilities, and personnel. The individual place settings are similar to those used for the informal meal styles. Few center items are used other than salt and pepper shakers, sugar bowls, and creamers.

The method of serving meal items distinguishes semiformal from informal meal styles. In the semiformal style, each food item is arranged on a separate serving dish in the pantry. It is then offered to each diner. Beginning with the meat or main course, each course is carried into the wardroom separately. The courses are presented to each diner in turn, starting with the head of the table. The senior guest or the individual designated by a buck is served first. Each diner selects desired items from the serving dishes and places them on his or her plate while the serving dish is held. Serving dishes are returned to the pantry after their contents have been offered to all the diners.

Informal Service

Several types of informal service are used in the wardroom mess. Those now in use include family, American, ala carte, cafeteria, and buffet styles.

FAMILY STYLE.— For this type of service the food is attractively arranged in the pantry or galley in the proper serving dishes. The food is then placed on the table with the proper serving utensils.

Each officer serves himself or herself and passes the serving dishes around the table. Dessert items that are to be served later can be brought in from the wardroom and placed on the sideboard. The serving dishes are replenished as necessary.

AMERICAN STYLE.— This type of service is used in most restaurants. The main course plate is not part of the initial place setting. Instead, individual plates are prepared in the pantry or galley and placed before the seated diners. This form of meal service is often provided in officers' messes on medium-sized ships. It is often combined with other traditional forms of service. In American service, food is placed on plates in the galley and taken to the wardroom and served to each diner.

A LA CARTE STYLE.— This type of service is usually provided at breakfast. As with the American style, the main plate is not part of the initial plate setting. Instead, the diner is given a menu or breakfast order form. The diner decides what food he or she wants and how it is to be prepared. The order is then delivered to the pantry or galley and the food is prepared as requested. It is placed on a plate and served to the diner as in the American style of service.

CAFETERIA STYLE.— This is the type of service that is used aboard some larger ships such as carriers and supply ships. The diner does not normally serve himself or herself. Rather, the diner selects the desired items and the foodservice attendant places them on his or her plate. However, salads, desserts, and some side dishes may be apportioned in dishes and the diner simply takes them from the serving line. The main course consists of vegetables, starches, and meat. These items are portioned onto a plate by the serving line attendants as the diner selects them.

BUFFET STYLE.— Buffet service may be used for both formal and informal occasions. This type of service is commonly used when either space or serving personnel are limited. The food is attractively arranged on a sideboard or serving table, and the officers and guests serve themselves. It is customary to place

silverware and other necessary dishes on the dining table so diners do not have to carry them. When seating at the dining table is not adequate, or for a stand-up buffet, silverware and napkins are placed on the buffet table. All foods may be arranged on the buffet, or some items may be taken from the buffet and served after the guests are seated.

Serving responsibilities for buffet service are fewer, but they are no less important. The buffet and dining table should be watched constantly so items are replenished before they run out; also, to remove soiled dishes immediately after use. After the diners are seated, the buffet will require constant attention so it remains attractive for latecomers or anyone desiring seconds.

When everyone has finished the main course, the main course foods should be removed from the buffet table. The dishes and used silverware should be removed from the table. If the dessert is to be served from the buffet table, the dessert and appropriate serving dishes should be arranged as soon as the main course foods are removed. Otherwise, the dessert should be served at the table.

DINING TABLE CENTER ITEMS

After setting the individual places, you should then set the dining table center items. These items include standard items that are typically used at every meal and meal-related items that may be included on the basis of menu requirements. The standard center items will always be placed on the dining table when setting up the table.

Standard Center Items

Figure 9-1 shows standard center items. The descriptions of these items are as follows:

- The sugar bowl is a small, silver, oval-shaped container with a short pedestal stand and lid. It is always set with a sugar spoon.
- Salt and pepper shakers may be all silver or they may be glass with silver tops. The salt should always be kept loose and dry. When placed on the dining table, both shakers should always be at least three-fourths full.
- The coffee cream pitcher is similar in size and shape to the sugar bowl but has a spout and no top.

One set of these standard items is provided for every six diners. However, a set of salt and pepper shakers is provided for every four diners. The standard center items are arranged with the sugar bowl centered between the salt and pepper shakers on one side of the table and the creamer on the other side. The salt shaker should be placed on the right side toward the head of the table.

Most ships consider some type of centerpiece as standard. This centerpiece usually consists of a silver fruit bowl containing either fresh or artificial fruit for breakfast or fresh or artificial flowers for lunch or dinner. If used, centerpieces should be lined up and arranged across the tables to present a neat, attractive uniform appearance.

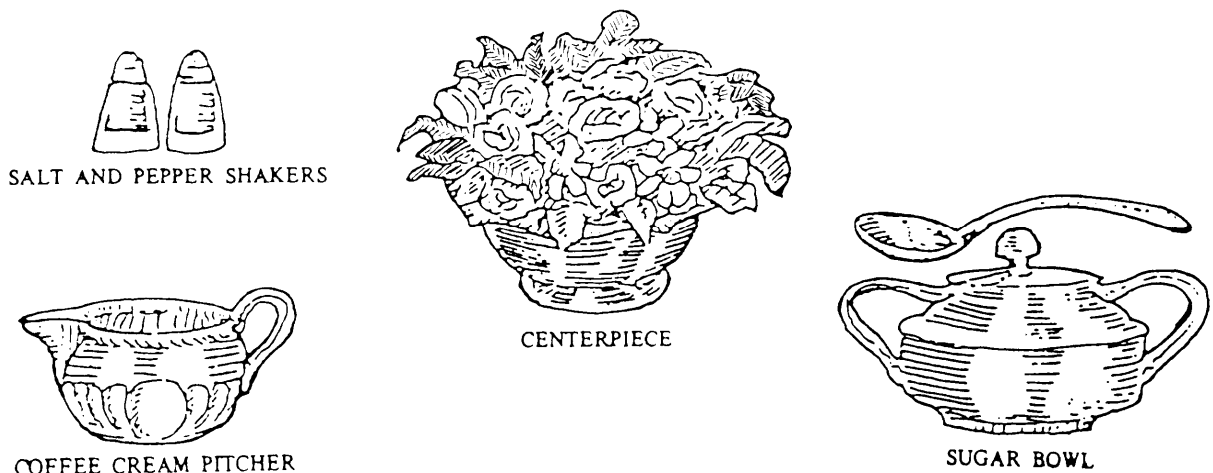

Figure 9-1. Standard center items.

Meal-Related Center Items

Figure 9-2 shows meal-related dining table center items. These items are explained next.

Cereal cream pitcher—The cereal cream pitcher is shaped like a small beverage pitcher with a modified hourglass design. It has a handle on one side and a capacity of 16 ounces. It is set only for breakfast or brunch when cereal is to be served.

Syrup pitcher—The syrup pitcher is similar in size and shape to the coffee cream pitcher. However, the pouring spout is partially enclosed by a metal lip. It is set only for breakfast or brunch when pancakes or waffles are to be served. It is placed on a coffee cup saucer.

Silver fruit bowl—The silver fruit bowl is a large hollow bowl. It is used for serving fresh fruit for

breakfast or brunch. It is often set as a centerpiece containing artificial or real fruit for breakfast or artificial or real flowers for lunch or dinner.

Bread tray—The bread tray is a rectangular silver dish with rounded ends and perforated sides. It is used primarily for breads, but it also maybe used for relishes such as cannot or celery sticks. When used for breads, an opened napkin is placed in the tray. The bread is then neatly arranged on the napkin, and the edges of the napkin are folded over the bread to retain freshness and warmth.

Cruet and caster—The cruet and caster consist of two stoppered glass bottles placed on a small tray. The bottles hold oil and vinegar salad dressings when salads are served at lunch or dinner.

Butter dish—The butter dish is a small, rectangular china dish with rounded corners. It is normally used at

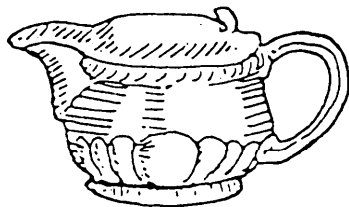

SYRUP PITCHER

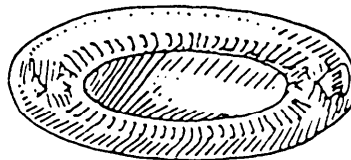

BREAD TRAY



BUCK



CRUET AND CASTER

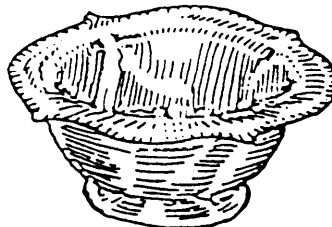

SILVER FRUIT BOWL



BUTTER DISH



PICKLE FORK

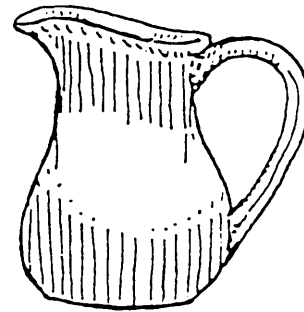

CEREAL CREAM PITCHER

Figure 9-2.—Meal-related center items.

all meals for serving butter patties. At breakfast or brunch, it can be used for serving jam or jelly packets.

Pickle fork—The pickle fork is used only at lunch or dinner when pickles or other relishes are served. It is placed on the relish (bread) tray. The pickle fork has three tines and is similar in shape to the diner's oyster fork but is slightly larger.

The buck—A buck is normally a small object such as a statue, a model, or a dummy weapon round. The buck is used aboard some ships to designate which diner is to be served first. It is not used at breakfast, at brunch, or when guests are to be served.

Meal-related items are selected on the basis of menu requirements. Examine the menu and identify those menu items for which related center items are normally used, such as jellies and syrup at breakfast. Pencils are supplied for falling out order forms.

For semiformal lunch or dinner, the bread, if served, is placed on the dining table after the main course item. For all informal-style lunch or dinner meals, bread is set 5 minutes before the meal.

DINING TABLE

When assigned to wardroom duty, you are responsible for setting the table for meals. Setting a table correctly helps avoid confusion at meals and allows the table to look neat and attractive. An attractively set table contributes to the enjoyment of the meal.

Linens

Linen is handled when preparing for a meal and when securing from a meal. All linen should be examined for cleanliness and serviceability before use. When linen is stained, torn, or frayed, it is not suitable for the table. Linen in this condition should be brought to the attention of the wardroom supervisor.

Linen Placements

All linen should be in place before the wardroom tables can be set. Linen also should be placed on the sideboard and, sometimes when appropriate, the buffet table. Linen that is worn, but clean and without stains, may be used on the sideboard if it can be neatly folded so the damaged parts are hidden.

Sideboard

Most wardrooms have a waist-high cabinet known as the sideboard. Its storage spaces are used for storing wardroom linen and tableware. The top forms a counter for the placement of hot and cold beverage services and extra tableware in preparation for a meal.

Napkins

When cloth napkins are to be used alongside plate settings, they should be folded flat and set aside. If napkin rings are to be used, napkins should be folded, rolled, and placed in the rings.

SETTING THE TABLE

Setting the dining table involves two basic tasks: setting individual place settings and setting the dining table center items. Steps for selecting and placing individual place settings and dining table center items are dependent on specific menus and styles of meal service. Variations in the procedures may recur. These variations are based on the way a specific mess maybe equipped and on the desires of the mess president and/or the wardroom supervisor. For instance, if there is a lack of a certain type of needed tableware, the wardroom supervisor should be asked to decide what item should be used as a substitute.

Setting Individual Place Settings

The dishes, silver, glasses, and napkin placed in front of one person are called a cover. The number of dishes and pieces of silver necessary for a cover depends on the occasion and the menu. Everyday meals require fewer dishes and silver than formal meals. Always check the menu before setting the table. Figures 9-3,

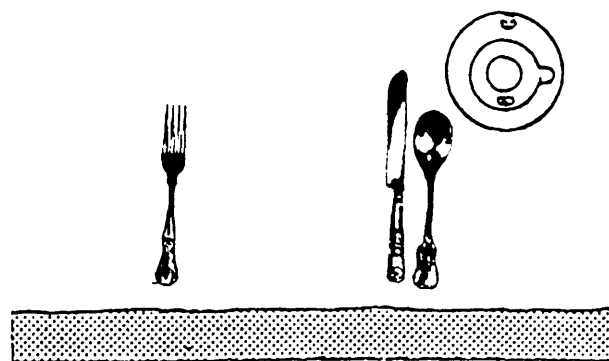

Figure 9-3.—Basic breakfast or brunch cover.

9-4, and 9-5 are the basic breakfast or brunch cover, the basic lunch or dinner cover, and the cover for an informal meal, respectively.

Individual place settings are traditionally arranged as follows:

Dinner or service plate—The dinner or service plate is placed directly in front of each chair. The ideal spacing of plates for family style or formal occasions is 24 inches from plate center to plate center. This is close enough to permit easy conversation and provides enough room for each diner. The dinner plate is not placed on the table when American, cafeteria, buffet, or a la carte style is used.

Silverware—Silverware is placed about 1 inch from the edge of the table and close to the plate. It is placed

according to the order in which it will be used—the outermost pieces being used first. Knives are placed next to the plate on the right side with the cutting edge toward the plate. Spoons are placed to the right of the knives with the bowl up. Forks, except oyster forks, are placed on the left side of the plate. When the oyster fork is used, it goes to the right of the spoon. Usually, not more than six pieces of silverware are placed at a cover. During a formal dinner, when additional silver is required, it is brought in with the course requiring its use.

Bread and butter plate—The bread and butter plate, when used, is placed to the left of the dinner plate, above the points of the forks.

Beverage glasses—The water glass is placed to the right of the dinner plate above the points of the knives. The water glass is set for lunch unless another chilled beverage is to be used. It is a wide, short 10-ounce glass and is used only for water. The beverage glass is a taller, narrower 10-ounce glass. It is used for lunch or dinner when milk, iced tea, or other chilled beverages are served. The juice glass is a small 6-ounce glass. It is not set but is used to serve juice when ordered by the diner. It is used only at breakfast.

Coffee cup—The coffee cup is set upside down on the saucer and is placed to the upper right of the outer spoon.

Napkin—The napkin can be either cloth or paper. It is placed either to the left of the forks or on the dinner plate.

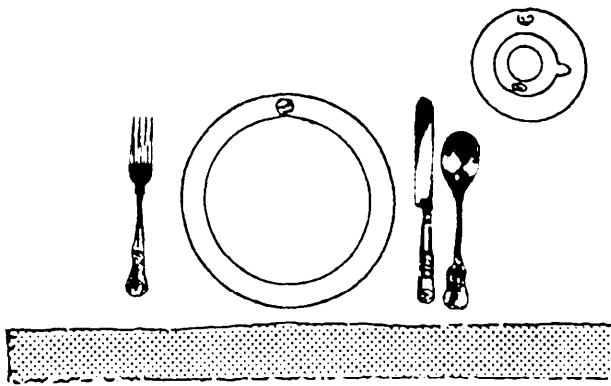

Figure 9-4.—Basic lunch or dinner cover.

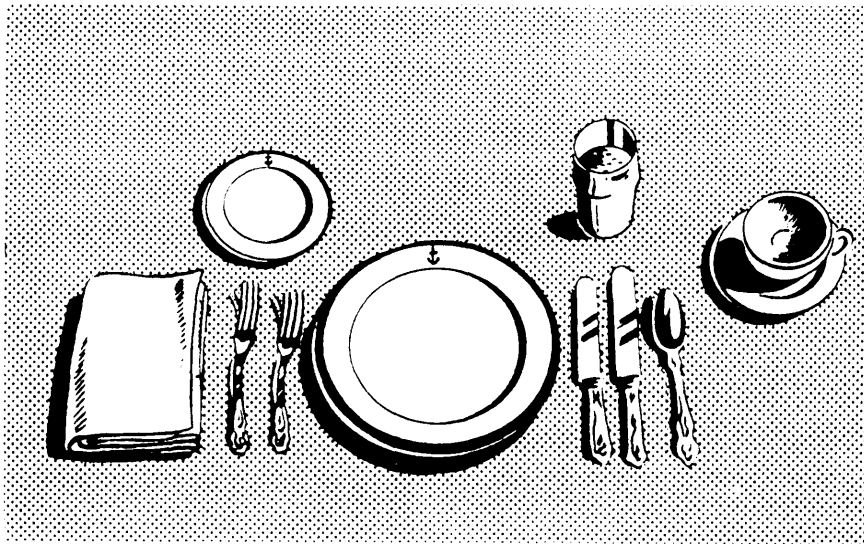

Figure 9-5.—Cover for an informal meal.

After all covers are set, check the table once again to see that all covers are alike and that nothing was omitted. Be certain that spoons are laid with bowls up and that the cutting edges of knives are turned toward the plate. Place the chairs so the front edge of the seats are just against or under the drop of the tablecloth.

Setting Place Cards

Place cards are usually used for such functions as formal or informal dinner parties when the persons attending may not know one another. Place cards are prepared to eliminate confusion. When used, the place card is laid flat on the napkin.

Setting Center Items

After setting individual places, you should then set the dining table center items. The standard center items discussed earlier in this chapter will always be placed on the dining table when setting up the table.

SETTING THE SIDEBOARD

The sideboard is normally where the hot and cold beverage services are set up for the meals. Additionally, extra tableware is placed on the sideboard.

Setting Up the Hot Beverage Service

The principal hot beverage used aboard ship is coffee. Hot tea or hot chocolate also may be used if desired by wardroom members. The hot beverage service should be set up following placement of the linen on the sideboard. The following steps explain beverage service setup.

1. To set up this service, you should take coffeepots from the sideboard to the pantry and obtain enough coffee for the meal. You should have one coffeepot for each 10 to 12 diners. Place the pots on the sideboard coffee warmers. Select at least one coffee pitcher for each dining table and place on the linen next to the coffee warmers. Coffee servers should be filled just before serving and should not be placed on the warmers.

2. To setup hot tea or chocolate, you should put hot water in a coffeepot and set it on the coffee warmer. Arrange tea serving pots next to the warmer. The number of teapots is determined by the wardroom supervisor or through experience. Tea bags or hot chocolate packets should be placed next to the serving pots.

Setting Up the Cold Beverage Service

To setup the cold beverage service, you should take serving pitchers from the sideboard to the pantry to obtain the cold beverages. Water is always made available even if another beverage is served. Cold beverages are prechilled and placed on the table just before announcing the meal. The pitchers should be ready on the sideboard for refills.

When fruit juices are included on the breakfast menu, a galley serving pan insert should be filled with enough ice to cover half the height of the glasses. It should then be placed on the sideboard, and the juice glasses then filled to the bulge with juice, and placed in the ice to cool.

Setting Up Extra Tableware

The required amount of extra tableware will normally be determined by the wardroom supervisor. Extra tableware should be included for occasional breakage of china during meals and the likelihood of unexpected diners. If a second seating of diners is required, tableware should be placed on the sideboard to permit quick resetting of the dining table after the first seating has finished.

Obtain and neatly place the necessary items on the covered portion of the sideboard. Dishes and bowls may be stacked several high. Cups and glasses should not be stacked, especially during rough seas. Silverware should be arranged by type and napkins should be prefolded and stacked near the silverware.

SETTING FOR BUFFET SERVICE

Buffet service was briefly described earlier in this chapter. However, there are unique sanitary considerations involved in the setup and operation of buffet- or cafeteria-style serving lines. Open serving pans and trays provide ideal sites for growth and spread of disease-carrying organisms. Following a few simple rules can reduce the chance of infection.

1. Always keep hot foods at temperatures above 140°F, Discard the food within 4 hours of the beginning of preparation if these temperatures cannot be maintained.

2. Display only limited amounts of food on the serving line at any one time. This permits the balance of food to be kept in the pantry for temperature control. Refill serving pans and trays only as necessary.

3. Finally, use a sneeze shield whenever possible.

The principal tasks involved in setting up the buffet serving line are presented next.

The serving line setup tasks should be done in the order listed and completed 5 minutes before serving time.

1. Make space for the buffet serving line. A buffet table should be located to allow MSs convenient access to the pantry for filling the serving pans. This also allows the diners to use the serving line easily without crowding from furniture or other diners.

2. Place the linen on a special buffet table or a selected area on the sideboard. Remove all nonessential items on the sideboard area when used to setup a buffet serving area.

3. Set up the chafing dish stands. Setup enough stands so there is at least one for each food item. Place them in the serving area so a diner can have ready access to them without leaning over the table. After the chafing dish pans have been set in place, put 1 inch of water into those pans that are for hot food. Sterno heating units are then placed below the center of the pans containing water. Make sure there are no flammable items placed near these units as the setup continues. Do not light the heating units at this point.

4. Place the sneeze shield now, if one is available. Do this in a way to make sure all food items are properly protected. Diners should still have ready access to the foods.

5. Determine what utensils will be needed. Then place all necessary eating utensils neatly at the beginning of the serving line. Napkins and silverware are usually placed on the dining tables. However, when there are more diners than seats, additional place settings should be kept on the sideboard. They should be placed on the dining tables after diners finish and leave, making room for additional diners. There are not always enough MSs to do the resetting. On these occasions, napkins and silverware should be placed on the serving line. They should be placed next to the china and away from the chafing dishes.

6. Set the decorations selected by the wardroom supervisor on the serving table. Decorations are usually artificial or real flowers arranged around the three sides of the serving area facing the diner.

SEATING ARRANGEMENTS

In the wardroom where regulations and precedence closely control seating arrangements, officers are assigned to permanent seats for daily meals. They are seated from left to right, as shown in figure 9-6 according to rank and precedence.

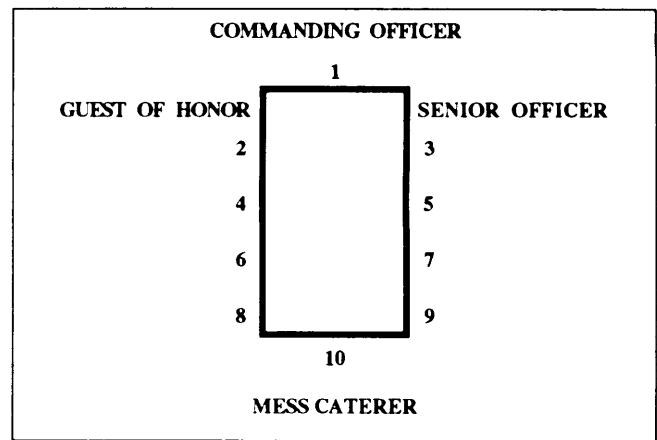

Figure 9-6.-Wardroom seating.

The senior line officer in command, or in succession to command, is the president. He or she sits at the head of the table, or at the head of the senior table when more than one table is used. The commanding officer who regularly eats in the wardroom is the president. When the commanding officer has his or her own mess, the executive officer is the president. The exception would be on large ships that have more than one wardroom. In this case, the senior line officer of each mess is the president. However, when the commanding officer or other senior officer is invited for an occasional meal, this officer is considered the guest of honor. In this case, he or she is seated to the right of the mess president.

The caterer sits opposite the president. The officer next in rank sits in the first seat to the right of the president. The officer third in rank sits in the first seat to the left of the president, and so on down the table. All line officers of the same grade take precedence with each other according to his or her respective dates of rank. When they have the same date of rank, their precedence is according to their lineal numbers as given in the official Navy Register.

Staff officers with the same date of rank as running mates of the line take precedence after their running mates of the line. However, they take precedence before all line and staff officers who are junior to the running mate. When officers of more than one staff corps have the same running mate, they take precedence in the following order: Medical Corps, Supply Corps, Chaplain Corps, Civil Engineering Corps, Judge Advocate General's Corps, Dental Corps, Medical Service Corps, and Nurse Corps.

When more than one table is in use, the treasurer usually sits at the head of the junior table.

When officers of other service branches have the same relative grade and the same date of rank, they have

precedence according to the time each has served on active duty as a commissioned officer of the United States Armed Forces. The seating arrangement changes when a guest is present. When several guests are to be present, the seating arrangements are normally worked out by the wardroom supervisor and approved by the caterer.

MEAL STYLE PROCEDURES

Meals should begin immediately after the president and the officers are seated. Prompt and courteous service add much to the enjoyment of a meal. Serving personnel should be alert. They should not lean on the sideboard or lounge against the bulkhead when they are not busy. With proper training, serving personnel will know what their responsibilities are and how they should be met.

The meal may be announced by using the xylophone (fig. 9-7) or by announcing the traditional "dinner (or whichever meal) is served."

The president or the officer in front of whom the buck is placed is served first, and then the service proceeds counterclockwise around the table.

WARDROOM CALL FOR LUNCH OR DINNER

PLAY THE Xylophone

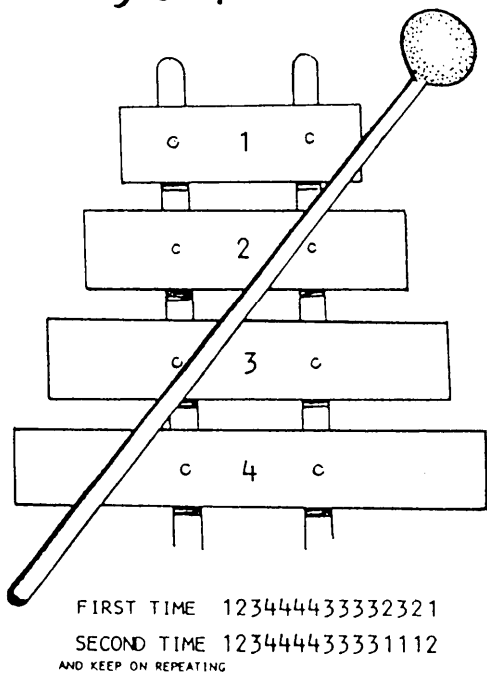

Figure 9-7.—Xylophone for announcing meals.

INFORMAL MEAL SERVICE

All meals are served by family, cafeteria, American, buffet, ala carte service, or by a combination of these, as discussed earlier. Figure 9-8 shows a table setting for an informal meal.

Foods, including soups, are served from the left of the person being served. Beverages are served from the right.

Soup is normally ladled into the soup plates in the pantry and served rather than offered to the officer at the table.

The rule of thumb to follow during formal and informal service is to serve the foods from the left and remove from the right, except beverages.

To avoid overcrowding the table during family-style service, refill the water glasses as necessary instead of placing a water pitcher on the table. In other types of service such as cafeteria, a water pitcher maybe placed on the table for those who desire refills.

Coffee should always be available and served piping hot. Be careful when serving coffee and other hot beverages especially aboard ship when the ship is underway. An accidental spill can cause a painful burn.

When an officer has finished a course, remove the used dishes. Do not stack the dishes in front of the officer. With the right hand, remove the plate and silverware used during the course. When more than one plate is being removed, hold the first in the left hand and place the others on top of it.

When desserts are not picked up from the line, they should be served. Place a pitcher of hot coffee on the table for those desiring seconds and place ashtrays within the officers' reach.

When guests are present, some changes to the seating and serving order are necessary. Although some of these changes were mentioned earlier, bringing them together at this point will help you to recognize what routines should be changed.

The buck is not used when guests are aboard. A guest of the ship or the guest of honor sits to the right of the president and is always served first. Other guests usually sit to the right of their host officer. When no guest of honor is present and more than one officer has guests, the guest of the senior host officer is served first. In all cases, after serving the guest of honor, the serving continues from that point counterclockwise around the table. Do not skip around in order to serve all guests first.

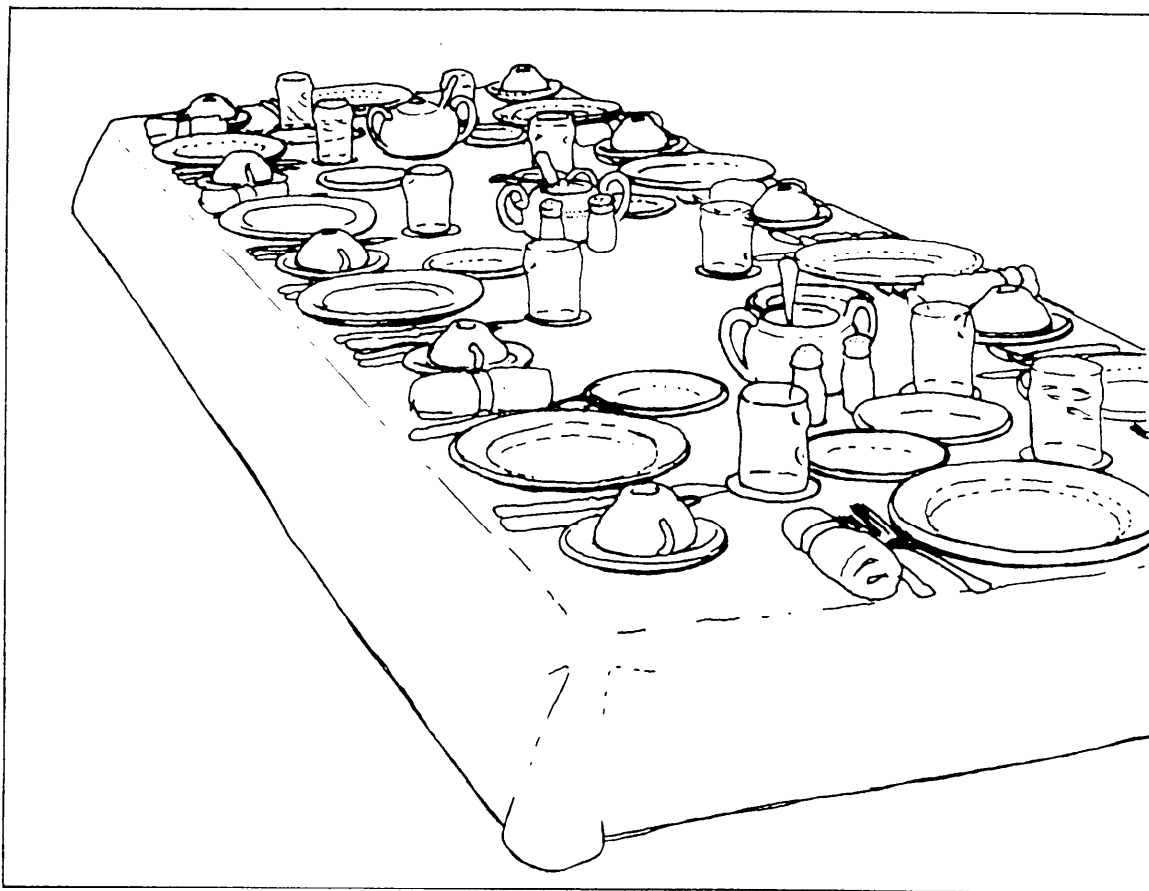

Figure 9-8.—Wardroom table setup for an informal meal.

FORMAL

The service required for formal meals is more elaborate than for informal meals. However, the table setting is basically the same as for informal meals. Usually four or five courses are served, but as few as three or as many as seven maybe served. All food from each course is served to all diners in prompt succession. For a formal dinner everything is served; nothing is set on the table except the salt and pepper shakers. Condiments and other seasonings are served at the proper time. A table setting for a formal dinner is shown in figure 9-9.

Service plates are normally used at formal dinners. These are large plates that are placed on the table at the time it is set for the meal. They are not removed until replaced by the heated dinner plate for the first hot course after the soup. They are used only because it is considered bad form for the diners not to have plates before them throughout the meal. No food is placed directly on the service plate. Instead, dishes containing the first courses of the meal are set upon the service

plate. Although bread and butter plates were never used for formal dinners in the past, they are frequently used today.

All foods are served from the left, and beverages are served from the right. Dishes are removed from the right. An exception to this rule is the replacing of silverware. These pieces of silverware that are placed to the right of the place plate are replaced from the right. In this way it is not necessary to reach in front of the diner.

When the meal being served uses the table setting pictured in figure 9-9, the following order of service would be observed.

As soon as the members and their guests are seated, the first course, shrimp cocktail, is served.

When all have finished the course, the shrimp cocktail glass is removed with the used silverware. The soup course is served next.

When all have finished the soup course, the soup plate, service plate, and soup spoon are removed. The



85.19

Figure 9-9.-Table set for a formal dinner .

heated dinner plate replaces the service plate for the main course. The food is brought in on a platter or in serving dishes. The food is presented to the guest who is seated to the right of the host. The service then proceeds counterclockwise around the table.

Upon completion of the main course, the dinner plate and used silverware are removed. The salad plate is then put in its place. To provide faster service, the salad is usually arranged on the salad plate before it is brought in.

When all have finished their salads, the salad plate and silverware are removed. At this point, the only items remaining from the original setting are the water and wine glasses. Before the dessert is served, the crumbs, if any, should be brushed off the table with a folded napkin and tray. The dessert course with appropriate silverware is then placed before the diners.

Coffee is served with the dessert course or following it. If cups are placed on the table and coffee offered to those who want it, service is from the right.

It is customary not to smoke at formal dinners until after the coffee or demitasse has been served. When allowed, at the proper time cigarettes and/or cigars are passed and ashtrays are placed before those persons desiring them.

SERVING BEVERAGES

The serving of beverages was discussed earlier; however, four general guidelines and several specific procedures for serving beverages will now be explained.

Formal Beverage Service

Since the formal style of service is quite elaborate, different beverages may accompany each course, and considerable guidance is needed for this to be done correctly. Guidance should be obtained from the wardroom supervisor and from other references.

Informal Beverage Service

The first guideline is that beverages are to be served from the diner's right if possible. Otherwise, check with the wardroom supervisor about how to serve the beverages in a way that disturbs the least number of diners.

The second guideline is that the server should never lift the diners' glasses or cups from the dining table to refill them. Rather, he or she should pour the beverage into them while they are on the table. If the cup or glass is not conveniently placed for service, carefully move it to a better location. If it cannot be reached, politely ask the diner to move it.

The third guideline is that the order of service for beverages is the same as that for the serving of foods.

The fourth guideline is not to fill serving pitchers to the top when used for filling glasses or cups at the dining table. A third pitcher is difficult to handle and feels quite heavy after a while. Therefore, pitchers should be filled between one-half and two-thirds full.

Finally, you must remember that each wardroom mess may have certain rules for serving beverages. The wardroom supervisor should be asked about these rules.

AFTER THE MEAL

You should immediately restore the wardroom to its pre-meal condition as soon as possible after the meal. Some helpful suggestions are as follows:

- Clear the table as soon as all officers have finished eating and have left the table.
- Remove all meal items from the sideboard and return all dishes, silverware, and ashtrays to the pantry for washing.
- Refill the salt and pepper shakers as needed and store them in the pantry.
- Remove buffet serving line items.
- Inspect the napkins and place the soiled ones in the laundry. Refold those suitable for reuse and replace them in their respective napkin rings (when they are used) and store in the napkin storage area. Single-service paper napkins are being used in many private messes for regular meals and cloth napkins are used only for more formal occasions.
- Brush the crumbs from the tablecloth. Be careful not to rub food particles into the fabric.
- Shake the cloth out lightly and refold it along its original creases. Reroll or refold the silence pad as appropriate, and store it with the tablecloth.
- Clean tables, sideboard, and chairs.
- Replace the table cover.
- Vacuum and sweep the deck of the wardroom.

SETTING UP FOR SPECIAL EVENTS

Navy commands traditionally sponsor events and ceremonies to acknowledge noteworthy accomplishments and achievements of Navy personnel. Command functions recognizing personnel promotions, reenlistments, retirements, command milestones, changes of command, and other similar events are vital to morale and tradition. These events usually include a reception which provides light refreshments of some variety.

As an MS, you will probably get tasked to provide your in-rate skill to help plan and prepare for the event, regardless of the occasion. This is especially so if food is involved. For example, you may be asked to decorate a special cake for the event. You may be tasked to prepare a special menu, which includes hors d'oeuvres and refreshments.

Some planning factors you should consider are theme determined by the occasion or event being planned and the number of guests that will be present. You also should consider the season and time of day. Arrange for indoor facilities if it is expected to rain or to be cold.

You should make sure the facility chosen is available when needed and that it includes the necessary space or capacity. You should inquire into the availability of all needed supplies and needed capable personnel.

Coordinate with other activities on the base to make sure other events are not scheduled that will conflict with yours.

You can avoid last-minute confusion and delays by preparing a master plan after the event has been planned in detail. Review this plan with all personnel who will be involved with the preparation and service. During the review, give personnel specific instructions on all assigned tasks. After the review, post the master plan where involved personnel can refer to it.

Check all necessity items of equipment to make sure they are functioning properly. The person in charge should check on chairs tables, podiums, and so on to make sure an adequate number is available on the scheduled date.

CHAPTER 10

QUARTERS AFLOAT AND ASHORE

This chapter explains the procedures used to operate and care for officers' quarters afloat. It also explains the organization of bachelor quarters (BQs) ashore and the resulting operational responsibilities that are assigned to MSs.

OFFICERS' QUARTERS AFLOAT

The Commander, Naval Supply Systems Command (COMNAVSUPSYSCOM) is responsible for providing administrative and technical direction for officers' quarters afloat. To discharge this responsibility, COMNAVSUPSYSCOM issues directives and letters of guidance and provides training and aid to operating personnel.

TYPES

Quarters on board ships are of several different types. Flag officers and commanding officers (COs) have their own mess and their quarters. They are normally larger and more like bedrooms than other officer quarters found on board ships.

Flag Officer

Quarters for flag officers include a stateroom and private head facilities. The staterooms are like small bedrooms ashore.

Commanding Officer

Quarters for the CO are like the quarters provided for flag officers.

Staterooms

Staterooms are berthing spaces provided for officers aboard ship. They are similar to small bedrooms. Officers other than flag officers, COs, executive officers (XOs), and sometimes department heads are billeted two to a stateroom.

ORGANIZATION

The mess caterer or, if there is no caterer, the mess treasurer is usually responsible to the mess president for the service, care, and maintenance of quarters afloat.

Mess Caterer

The mess caterer is responsible for the efficient management of the officers' staterooms, including maintenance and repair of government-owned equipment and stateroom facilities. The caterer is also responsible for providing linen, laundry, and cleaning services.

Leading Mess Petty Officer

The senior enlisted person assigned to the wardroom mess is the leading mess petty officer. The leading mess petty officer is responsible to the mess caterer for both the supervision of foodservice and stateroom service personnel. He or she also oversees the details of the daily wardroom mess operation.

Stateroom Supervisor

Ship's size often dictates whether or not a stateroom supervisor is assigned. If assigned, the stateroom supervisor is responsible to the leading mess petty officer for supervising the personnel assigned to stateroom service.

As an MS, you may be assigned to supervise stateroom services afloat. As a supervisor, you are expected to manage and coordinate the activities of personnel who provide stateroom services. Your duties may include but are not limited to the following:

- Planning the work schedule
- Developing efficient methods for cleaning and maintaining the staterooms using limited cleaning equipment and supplies available
- Practicing proper inventory management regarding linen, supplies, and cleaning equipment

- Being familiar with the location of each stateroom, the easiest route to the ship's laundry, and laundry pickup schedules

Other Assigned Personnel

MS personnel are responsible for performing functions associated with the management and operation of officers' quarters afloat. However, a rotational pool of enlisted personnel in paygrades E-1 through E-3 may be provided to aid the MSs in providing maintenance, cleaning, and other services.

When assigned, the rotational pool is under the supervision of an MS and may perform the following duties:

- Daily bed-making services and weekly bed linen changing for the CO, XO, unit commander, and officers in paygrades O-5 and above
- Maintenance and cleaning of all staterooms and associated living spaces
- Cleaning of passageways and heads in officers' quarters
- Making sure officers' beds have clean linen, and soiled hand and bath towels are changed twice weekly, airing bedding, turning mattresses, vacuuming bunks, washing paintwork, and having chair covers and bedspreads dry-cleaned quarterly
- Assisting MS personnel in the cleaning and maintenance of foodservice spaces including wardroom service and food preparation

OFFICER REGISTRATION

In an ideal situation, the wardroom officer would be told before an officer's pending arrival. Normally, a new officer is assigned to a stateroom by the wardroom officer or mess treasurer. In some ships, the stateroom of an outgoing officer will be occupied by the relieving officer. Registration procedures vary between ships. However, the Registration Record, NAVCOMPT Form 2104, is recommended for use in registering officers. Afloat, the reverse side of this form also can be used to record financial transactions between the officer and the wardroom mess. An example is the payment of his or her monthly mess bill.

AFLOAT STATEROOM SERVICE

Basic officer stateroom maintenance service, which includes sweeping, dusting, sink cleaning, painting, laundry services, and care of private effects, is explained next.

STATEROOM CARE

The work required in the maintenance of the wardroom and staterooms is not physically hard. However, it does require a sense of orderliness and attention to detail. It also requires an understanding of the important role played by MS personnel in support of the ship and the Navy. The specialized support provided by the MS rating within the wardroom/stateroom areas is as necessary to the Navy as specialization provided in the weapons and engineering areas.

Staterooms must be thoroughly cleaned. This includes furnishings, ledges, corners, and bulkheads. The same cleanliness is required for heads, showers, passageways, and vestibules.

Access to Staterooms

The wardroom and staterooms are officers' country. The mess personnel duties and their continuous presence in officers' country produce an especially close relationship between the enlisted personnel and mess officers. Successful wardroom operation depends upon the mutual trust and respect of this relationship. This trust results from high levels of personal honesty and integrity. The wardroom and stateroom areas are out of bounds to personnel other than mess members and mess personnel. The only exception may be for official business related to those spaces.

Care of Private Property

One important rule to follow in cleaning staterooms is to avoid disturbing anything of a private nature that has been left laying about. Occasionally, officers rush off leaving letters, papers, money, or other valuables in sight. These instances should be reported at once to the officer, the wardroom leading MS, or the stateroom supervisor. Furthermore, papers, books, or letters should not be examined if left laying around. These may concern official Navy matters or the officer's personal affairs. In either case, they are to be treated as private property. If valuables or other private items must be removed when cleaning, you should make sure they are put back where they were found.

Cleaning of Staterooms

Daily cleaning is necessary, but the extent to which spaces are cleaned may vary with particular circumstances. More uniform cleaning can be done by using a cleaning bill. An example of a stateroom cleaning bill follows:

DAILY

- a. Clean washbasin, mirror, soap container, and toothbrush holders.
- b. Make up beds for officers 0-5 and above.
- c. Sweep and mop deck or vacuum carpet.
- d. Empty and wash ashtrays.
- e. Empty wastebaskets.
- f. Dust all furniture.

WEEKLY

- a. Wash paintwork.
- b. Polish brightwork.
- c. Clean electric fans and wipe down light fixtures.
- e. Replace soiled hand and bath towels and replace with clean ones as scheduled.
- f. Deliver and pick up officers' laundry as scheduled.
- g. Replace stripped linens with fresh clean ones. Leave linens on top of beds (0-4 and below only), as scheduled.
- h. Scrub and wax deck or spot-check carpet and remove stains as scheduled.
- i. Clean air-conditioning filters and screens.
- j. Hold general field day for certain staterooms as scheduled. Stand by for inspection.

CLEAN AS SCHEDULED

- a. Turn mattress over and vacuum underneath (monthly-preferably during linen change).
- b. Send draperies, curtains, chair covers, and bedspreads for dry cleaning (quarterly).
- c. Shampoo carpets (quarterly).

Personal Service

The following services are considered of a personal nature and are the sole responsibility of individual officers:

- Bed making and bed linen changing except for 0-5 and above
- Care, maintenance, and orderliness of personal effects that include military uniforms, uniform accessories, and shoes
- Sorting and storage of personal laundry

Mail Service

MSs may be appointed to act as mail orderlies. As mail orderlies, they pick up the mail from the staterooms at prescheduled times and deliver it to the post office. MSs also may draw officer mail from the Postal Clerk and deliver it. Mail not delivered should never be left in the wardroom. Mail orderlies must not be required to mail or pickup registered, certified, or insured mail.

HABITABILITY

Officers' quarters aboard ship (staterooms) should present maximum habitability. COs usually require the highest standards of service and sanitation in the ship's staterooms. There is no ship so lacking in facilities, equipment, or personnel that minimum standards cannot be met. Careful use of supplies and overhaul funds on allowed items should be exercised within the limitations of funding. This will achieve the maximum level of habitability. Improvisation with tender assistance may correct ship-design defects.

Since an officer's quarters is his or her seagoing home, the officer should not be reluctant to spend his or her efforts toward the physical improvement of the wardroom and stateroom.

Care of Heads and Showers

An example of a cleaning bill for stateroom heads and showers follows:

DAILY

- a. Clean washbasins and wipe down mirrors.
- b. Refill soap and towel dispensers.
- c. Clean utility sink and storage area.
- d. Wipe down shower curtains.

- e. Scrub down shower stalls.
- f. Wipe down glass doors or stainless steel doors.
- g. Scrub rubber mats and air dry.
- h. Scrub, clean, and disinfect/sanitize urinals and commodes (use rubber gloves).
- i. Wipe down partitions or dividers.
- j. Sweep and swab deck with hot soapy water and disinfectant.
- k. Replenish toilet paper.
- l. Empty trash can.
- m. Clean and neatly store all cleaning gear in locker.

WEEKLY

- a. Scrub down bulkhead.
- b. Clean overhead and light fixtures.
- c. Scrub down shower curtains; replace as required.
- d. Descale urinals and commodes.
- e. Wipe down and polish stainless steel and all other brightwork.
- f. Sweep, swab, and scrub deck with hot soapy water and disinfectant.

CLEAN AS SCHEDULED

- a. Replace burned-out bulbs as required.
- b. Replace missing curtain hooks and rubber mats.
- c. Check for water leaks; cold and hot water.

Passageways and Vestibules

Passageways and vestibules are also important parts of the responsibilities of MSs and rotational pool personnel and must be incorporated in both the daily and weekly schedules. An example of a passageway and vestibule cleaning bill follows:

DAILY

- a. Sweep down ladders; vacuum if necessary.
- b. Sweep, swab, and buff passageways and vestibule decks.
- c. Wipe down ladder handrails with hot soapy water.

- d. Clean around deck combing or hatch openings.
- e. Check angle irons and ledges for gear adrift.
- f. Clean scuttlebutt.

WEEKLY

- a. Spot-check bulkheads and scrub down as required.
- b. Sweep, swab, wax, and buff decks.
- c. Dust overhead, light fixtures, and air vents.
- d. Clean baseboards and make sure all corners are completely cleaned.
- e. Scrub down ladders and dust guards with hot soapy water.
- f. Clean knife edges of hatches and ports.
- g. Polish brightwork as scheduled.

CLEAN AS SCHEDULED

- a. Strip wax once every 2 weeks or as scheduled.
- b. Check nonskid deck treads; replace as required.
- c. Check for burned-out bulbs and replace as required.
- d. Check quarterly for preservation and paint as required.

Care of Deck Coverings

There are various types of floor coverings such as vinyl, linoleum, and terrazzo provided for the interior decks. These coverings require special care. Rough and improper maintenance quickly destroys the appearance and durability of these coverings. Before cleaning and finishing these coverings, you should refer to the NAVSUP P-421. This gives information on the proper cleaning solution and the type of wax that should be used.

Carpet Care

The ability of carpets to perform most of the functions of many materials that are used as deck coverings has long since been acknowledged. Overall safety factors and low maintenance costs make carpeting a far more desirable and flexible environmental control material than any hard surface material that performs only a single function.

PREVENTIVE MAINTENANCE.— Maintenance time and costs can be extremely reduced and a good overall appearance of carpets can be maintained by eliminating soil and dirt before they are tracked into staterooms. Mats placed outside on inside entryways will eliminate most of the soil from shoes before it can be tracked onto the carpet. Critical high traffic areas, such as hallways and entrance doors, take the brunt of soiling. Frequent vacuuming and preventive maintenance in the high traffic areas will reduce the amount of time required to maintain these areas.

MAINTENANCE PROGRAM.— Carpet maintenance is directly related to the amount of traffic in the area.

- Daily. Clean with vacuum cleaner along all traffic patterns. It is extremely important to keep carpets as free as possible of hose, sandy, gritty soil. Remove spots and stains as they occur, if possible.

- Weekly. The pile brush combines a brushing and vacuuming action. It should be used at least once a week in addition to the regular cleaning and vacuuming.

proper shampooing procedures require the use of a neutral, synthetic detergent that is specifically designed for cleaning carpets. First, pile brush the carpet against the lay of the pile, then vacuum the carpet thoroughly.

During the actual shampooing, all furniture should be removed. Shampoo the carpet in circular strokes, with a uniform application of suds. After the shampooing, spot-clean any stains that remain. Following this, give the pile a finishing operation by hand-napping. Normally, drying takes 6 to 8 hours. In areas of traffic that must be used before the carpet is thoroughly dry, nonstaining paper should be placed on the carpet to prevent tracking soil onto the fabric. As a final operation, vacuum the carpet on the following day to remove any fluff and lint loosened by the shampooing process.

SPOTTING PROGRAM.— A separate spot-cleaning program should be established, especially for areas where accidental spillage occurs at a higher rate. There are many excellent commercial spot-removal kits available for this type of use. Spills should be attended to as soon as possible and never left for more than a day.

DUST AND DIRT.— Carpets are cleaned primarily to remove soil, to try to restore the original color, to lengthen wear life by the removal of gritty soil, and to discourage mildew and other unsightly damages. A good carpet care program will save time and money.

LOW MAINTENANCE.— Carpeting requires only about half as much time to maintain as hard-surfaced decks. Demonstrations should be obtained from professional carpet cleaners before starting your own carpet care program.

Control of Linen, Cleaning Equipment and Supplies

Aside from being expensive, supplies afloat are limited. A separate record should be kept for linen, cleaning equipment, and consumable supplies. You should set up a high limit and a low limit for all items used to help determine your requirements.

BACHELOR QUARTERS ASHORE

BQs are established to provide essential lodging for eligible personnel. Complete guidance for management of BQs ashore is given in the *Navy Bachelor Quarters Manual*, NAVPERS 15606. The Chief of Naval Operations (CNO) has assigned the responsibility for providing administrative and technical guidance for operating Navy BQs to the Bureau of Naval Personnel (BUPERS). To discharge this responsibility, BUPERS issues directives and requires financial reports for BQ billeting funds. It also provides technical aid and training for BQ officers and operating personnel. The Navy's commitment to operating effective BQs ashore is summarized next.

The Navy has an obligation to provide all authorized residents of Navy BQs with a healthful living environment located in clean, well-maintained, comfortable facilities. To meet this obligation, sufficient resources, including personnel, facilities, and funds, will be committed. Further, Navy BQs will be operated in a reamer that will provide the residents with as much privacy, security, and freedom as possible.

Navy BQs must be managed in a manner that conserves resources and protects the Navy's investment in facilities and furniture, fixtures, and equipment (FF&E).

To provide the level of professional management necessary for Navy BQs, a trained core of managers is required. These managers are drawn primarily from the MS rating.

As an MS, you maybe assigned duty in a BQ ashore in either bachelor officers' quarters (BOQs) or bachelor enlisted quarters (BEQs). Wherever or whatever your specific duties, to perform them well, you must be

thoroughly knowledgeable, have leadership ability, and be a service-oriented individual.

BQ MANAGEMENT ORGANIZATION

The BQ management organization is centralized in Washington, DC, under BUPERS (PERS-671) and has the following responsibilities:

- Developing and implementing administrative procedures for Navy BQs
- Achieving the objectives of the Navywide personnel support facilities (PSFs) within the overall objectives of the Military Construction (MILCON) Program
- Evaluating the habitability, occupancy criteria, and design of BQs
- Developing policy that governs assignment, determination, and use of bachelor housing
- Providing liaison to the Chief of Naval Education and Training (CNET) with a view toward establishing and improving BQ management training
- Inspecting BQ operations by use of the BQ management assistance and inspection team (MAIT) to ensure compliance with NAVPERS 15606 and other applicable directives
- Providing helpful suggestions and recommendations to improve living conditions, reduce costs, and provide classroom and on-the-job training tailored to each command's needs

CLASSIFICATION OF PERSONNEL ASSIGNED DUTIES IN BQs

MSs are normally assigned command supervision, management, and administrative billets in BQs. When MS personnel are not readily available, officers, chief warrant officers, or other enlisted personnel may be assigned. Enlisted personnel are prohibited from performing housekeeping functions in BQs other than their own personal spaces.

BQ personnel also may include civil service, nonappropriated fund, and contract employees.

Civil Service Employees

Civil service employees are civilian employees paid from appropriated funds. They may be assigned duties in BQs where military personnel are not available.

Under these circumstances, civilian personnel may serve as BQ, BOQ, or BEQ officer, or other positions that gives them the responsibility for the proper operation and management of the BQ. Information governing civil service employees can be found in the *Federal Personnel Manual*.

Nonappropriated Fund Employees

Nonappropriated fund employees are civilian employees paid from nonappropriated funds. Additional information and requirements about nonappropriated fund employees are contained in SECNAVINST 5300.22.

Contract Civilian Employees

Contract civilian employees are not governed by any of the regulations mentioned previously. Compliance to the provision of the contract and any collective bargaining agreement applicable to employees performing on this contract are subject to the requirements of the Service Contract Act.

OPERATIONAL RESPONSIBILITIES

Centralization of management refers to the direct management control of all BQs (less those assigned to the U.S. Marine Corps) by the CO on whose real property account these buildings appear. It additionally refers to consolidation under one specific department (for example, administrative, supply, or BQ) in the chain of command. Under the management system, tighter control, better accountability, greater occupancy of quarters, and further savings in resources can be realized.

Liaison must be set up between the BQ officer and tenant representatives to discuss responsibilities, establish communications, and promote a cooperative atmosphere to improve conditions and habitability of the personnel concerned.

Responsibilities of the host CO are as follows:

- Development and implementation of rules and regulations
- Assignments and terminations, including issuance of all certificates of nonavailability (CNA) and approval of all authorizations for payment of basic allowance for quarters (BAQ, single)
- Use of housing assets and preparation of inventory, occupancy, and utilization reports

- Review of all reports containing BQ information including cost, maintenance, and performance data
- Control of issue, repair, and procurement of furnishings
- Coordination of utilities conservation efforts and facilities management activities
- Development of BQ requirements surveys and development of program data

Responsibilities of the tenant CO are as follows:

- Support host command BQ regulations
- Participate in quarters inspections regularly
- Provide self-help program for the improvement of bachelor housing
- Provide host with information as to personnel drawing single BAQ in compliance with host policies and procedures
- Inform BQ officer of troop movements

More detailed information regarding the responsibilities of the host and tenant CO can be found in NAVPERS 15606.

BQ Advisory Committee

The purpose of the BQ advisory committee is to give residents a direct line of communication to management and command without being diluted or filtered. The committee deals with many areas of resident involvement, some of which are as follows:

- Determining residents' likes or dislikes
- Hearing suggestions and complaints
- Fostering self-help programs
- Improving resident involvement
- Gaining resources for the BQ
- Organizing resident action
- Establishing command positions
- Helping reduce vandalism and theft problems

Membership in the BQ advisory committee must be voluntary and representative of a cross section of the occupants. This cross section of occupants should be based according to rank and rate, building, floor, or wing. (The committee chairperson is selected from the group.) The meetings should be attended by the BQ

officer and building petty officers (BPOs). BQ staff members should keep a low profile and do not have a vote. It may be beneficial to invite the host CO, XO, department heads, and Navy exchange officer to periodically attend these meetings as observers. These meetings should be open to all hands who live in the quarters.

The meeting place, time, and date should be announced at least 1 week in advance. It is preferable to schedule it at a regular time, for instance, the first Monday of every month at 1800 hours. The minutes should be forwarded to the CO for comment via the chain of command. The CO will make comments as appropriate and return them to the residents. The minutes with the CO's comments should then be posted on the official bulletin board and in the BQ newsletter. The largest circulation possible is desirable.

The advisory committee is not intended to replace the normal chain of command. It should be used along with the chain of command to be beneficial. The advisory committee should not engage in management decisions or duties.

TIQ Officer

The CO appoints a BQ officer who holds the position on a full-time basis. The following are some of the authorities and responsibilities of the BQ officer:

- Manages the BQ assets
- Serves as communication link between public works, the XO, and the BOQ or BEQ officer
- Authorizes work requests for corrective and preventive maintenance
- Is responsible for proper administration and operation of the front desk
- Is responsible for providing accommodations that meet minimum adequacy standards
- Serves as the COs designated representative for the certification of nonavailability of quarters
- Maintains and is accountable for nonappropriated funds
- prepares and submits budget for operating the BQ to the CO
- As appropriate, originates or provides input to all correspondence on the BQ operation. This is

especially so for BQ inventory, occupancy, and utilization reporting, per NAVPERS 15606.

The BQ officer is provided with an operating budget for the purchase of custodial equipment and supplies, office equipment and supplies, and linen.

BOQ and BEQ Officers

The BOQ and BEQ officers are the direct representatives of the BQ officer. In this capacity, they are responsible for the administration and management of both the BOQ and BEQ. Figures 10-1, 10-2, and 10-3 are provided to give an overview of the BQ, BOQ, and BEQ organizational frameworks respectively.

Normally, the BOQ and BEQ officers have the following similar responsibilities:

- Exercise overall supervision of operating the BOQ or BEQ, including budgeting and comprehensive planning
- Serve as custodian of all records and property of the BOQ or BEQ
- Assign duties and supervise the work of the enlisted personnel and civilian employees engaged in the various activities of the BQ
- Set up a continuing training program for all operating personnel
- Verify the receipts of merchandise and equipment
- Maintain accurate records and accounts of the BQ

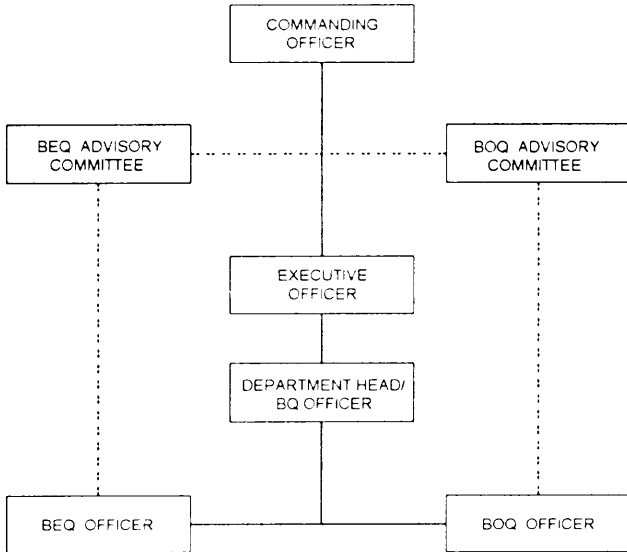

Figure 10-1.—BQ organization.

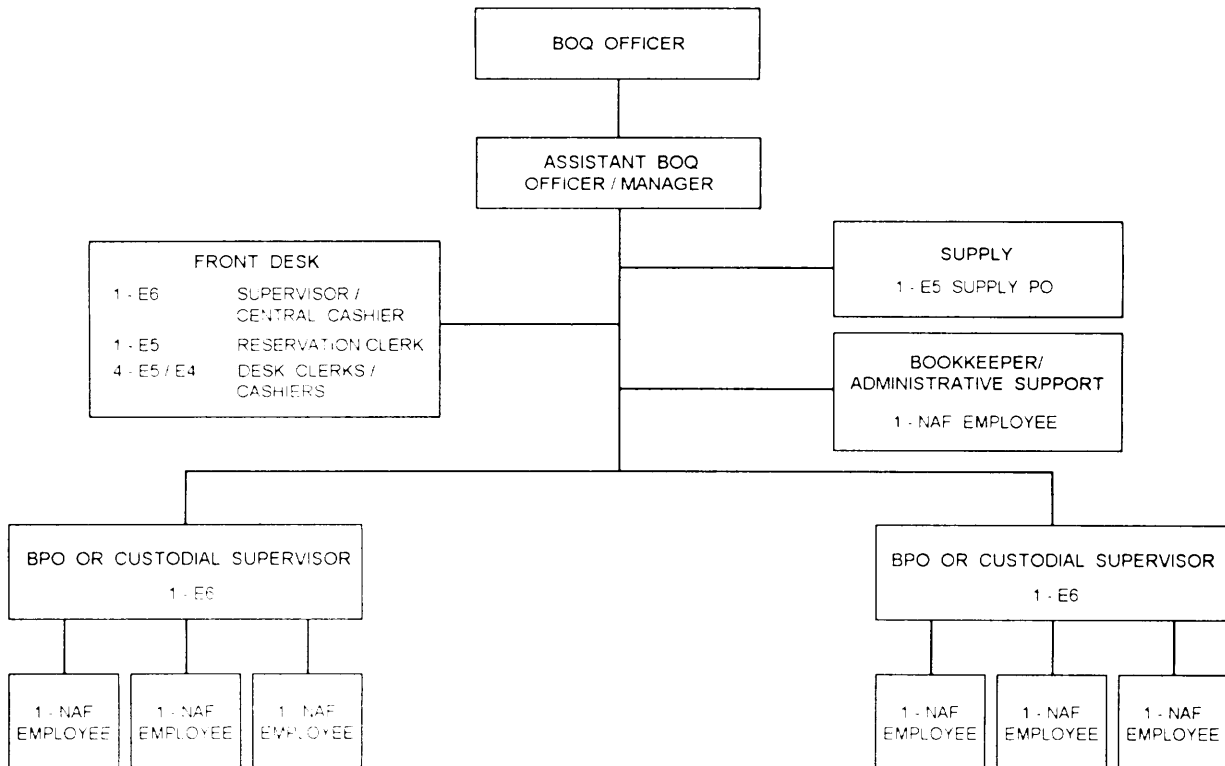

Figure 10-2.-BOQ organization.

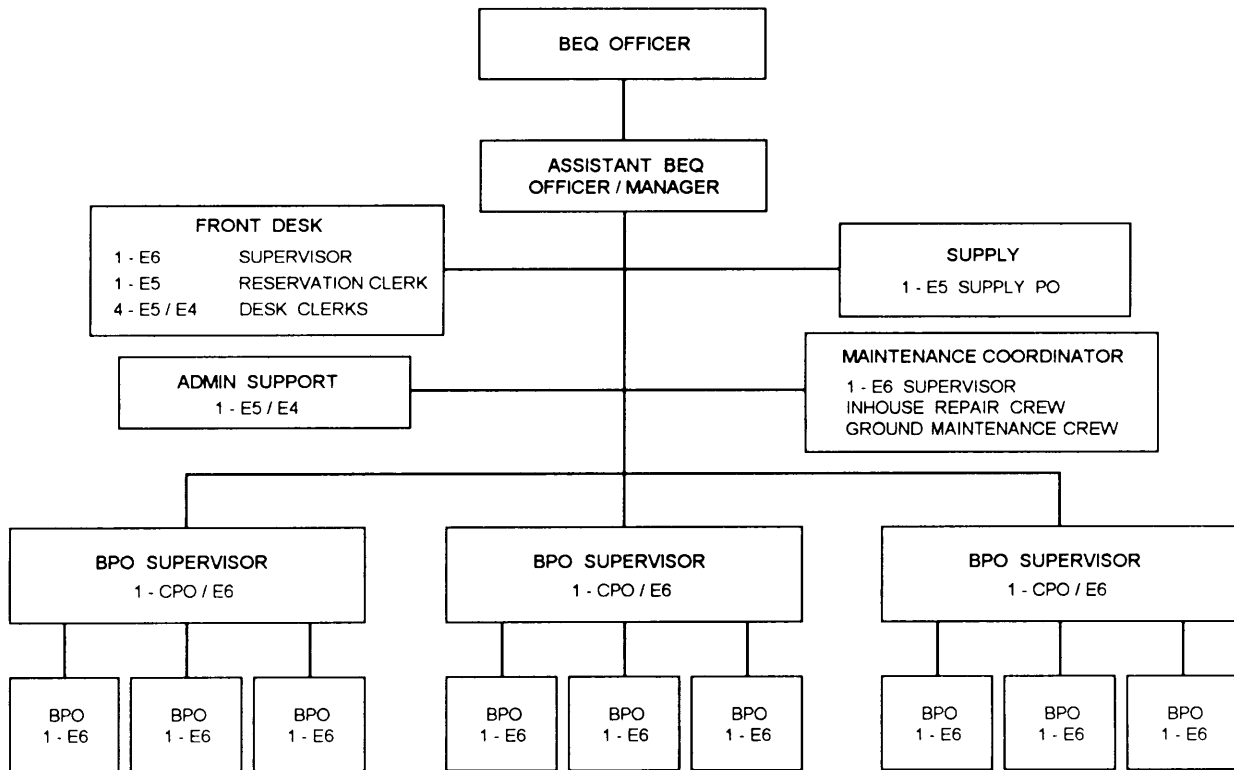

Figure 10-3.-BEQ organization.

- Act as division officer for the enlisted personnel assigned to the BQ
- Sign purchase orders when present; otherwise, assign this duty to the purchasing agent who meets or contacts vendors
- Are responsible for the receipts, safekeeping, deposit, disbursement, and accountability of funds
- Prepare monthly financial statement of the BQ

Front Desk

To maximize the effective use of limited staffing resources, establishing a front desk is strongly recommended. Where the presence of outlying quarters makes it impractical to maintain a central desk, a satellite desk is recommended. A further savings in resources can be realized by locating both the linen issue and cleaning gear check-out point in one central area. The size of the BQ complex determines the number of personnel required to meet these functions. The front desk personnel are responsible to the BQ officer.

The front desk is one of the first places an incoming individual encounters. Thus, the front desk personnel must provide a courteous and prompt berthing

assignment in a service-oriented, responsible atmosphere. Since first impressions are often lasting ones, the front desk is the point at which the individual should be greeted and issued the BQ welcome aboard pamphlet. It is the front desk clerk who should be able to answer incoming personnel inquiries about meal hours and base transportation. Residents should be advised of their responsibilities while living in the quarters at check-in time.

The front desk is the single contact point for the initial issue of linen, room assignments, and keys. Use of this method in the assignment of all BEQs and BOQs results in tighter control and better accountability. It also results in fuller use and more accurate reporting of matters on the availability and capacity of quarters, such as the number of per diem authorizations granted.

Some physical facilities do not permit guests and visitors access to the functional living area of the occupant. For this reason a special emphasis should be placed on the appearance of the front desk area. This is because it will serve as the locator and waiting or meeting area for the occupants and their guests.

The front desk clerk must have training, the necessary equipment, and a guide that specifies the list

of duties. Each duty should be explained separately and should be broken down into detail.

The front desk clerk has the following responsibilities:

- Must know the charges that must be collected from certain categories of guests. List of charges also should be posted at the front desk.

- Handles service and other charge payments for the BQ billeting fund.

- Must be instructed on how to prepare and complete BOQ and BEQ registration cards and computerized forms.

- Must be courteous, tactful, and maintain a standard method to welcome the incoming residents. The front desk clerk must be familiar with and have read the *Navy Customer Service Manual*, NAVEDTRA 10119-B1.

- Administers the provisions of NAVPERS 15606 and all pertinent Navy and local BQ instructions.

- Provides check-in and check-out service 24 hours a day, 7 days a week.

- Maintains locator file.

- Assigns all personnel (permanent and transient) to adequate rooms or space according to the BQ occupancy plan.

- Prepares and compiles the daily utilization worksheet.

- Coordinates and monitors public works trouble call logbook if a maintenance coordinator is not assigned.

- Maintains strict and accountable room key controls for the entire BQ. Refer to the NAVPERS 15606 for detailed information on actual BQ key control procedures.

- Acts as the BQ officer's representative during nonworking hours.

- Acts as cashier, handles all incoming funds, and cashes personal checks of the residents.

- Acts as custodian of all lost and found articles. Maintains records at the front desk. Periodically posts a list of items on the bulletin boards, publicizing items that have been found.

- Makes sure sundry items, if sold at the front desk, are available to meet the patron's requirements. This is done for the convenience of the patron regardless of the hour that the patron may request this service.

The front desk clerk should make every effort to furnish guests with information that will be helpful to them during their stay at the activity. Bulletin boards and comprehensive information brochures or welcome aboard pamphlets must be standard procedures in all BQs.

WELCOME ABOARD PAMPHLETS.— The front desk clerk must make sure all residents of the BQ who are reporting for permanent duty receive a welcome aboard pamphlet. This pamphlet is the primary source of information for residents and should be provided during check-in. To be effective, the welcome aboard pamphlet should be directed toward the BQ occupant and kept to a readable size. The BPO should review the pamphlet with the new resident and answer questions that may arise. A transient fact sheet maybe provided to all personnel in a transient status to reduce costs. Transient fact sheets cost much less to produce than full welcome aboard pamphlets.

The following items are mandatory for a welcome aboard pamphlet:

- Copy of the BQ regulations

- List of all services provided (exchanges, churches, special services) and their hours of operation

- Base map

- Civilian and military transportation available and schedules of this transportation

- Phone numbers of all emergency and service organizations

- Any information about environmental factors such as hurricane conditions, excessive hot or cold periods or seasons, possible flooding, and dangerous animals

- The warning signals for any emergency situation must also be given

- Applicable service charges for rooms

Additional Items.— The command also should consider including the following:

- Off-base recreation available

- Command letter of welcome

- Suggestion/complaint form

Transient Fact Sheet.— When providing an information sheet for transients, the following must be included:

- Condensed version of the BQ regulations, especially as they apply to transient residents
- Services offered and hours of operations
- Transportation available and schedules
- Emergency phone numbers
- Applicable service charges for rooms
- Base map

SUGGESTION BOXES.— Suggestion boxes are a good means of setting up communication between residents and the BQ officer. At small commands these boxes must be placed at the front desk. Large commands must place them in service areas such as

vending areas and laundries. The key to the suggestion boxes should be in the custody of the BQ officer. The BQ officer should make sure each suggestion receives a personal or written response. (See fig. 10-4.) The success of the suggestion box is based primarily on providing positive feedback to the occupant. The suggestions should be discussed at the BQ advisory committee meetings and posted on the bulletin boards with appropriate comments. Consideration should also be given to publishing the suggestions and responses in the BQ newsletter. Suggestions should be forwarded through the chain of command to get the required actions.

NEWSLETTERS.— The BQ newsletter is an excellent method for providing BQ residents with information on current events taking place in the BQ. The newsletter must be kept short, interesting, worth reading, and directed toward the residents. Some of the items that may be included in the newsletter are as follows:

SAMPLE FORMAT
BQ SUGGESTION SHEET

To: BQ OFFICER/MANAGER DATE: _____

From:

(Name and Rate)	SSN	Bldg #	Room #
-----------------	-----	--------	--------

COMMENTS

To:

(Name and Rate)	SSN	Bldg #	Room #
-----------------	-----	--------	--------

(This portion to be completed by management)

(Explain what action was taken)

THANK YOU FOR YOUR CONCERN

The Management

Figure 10-4.—Bachelor quarters suggestion sheet.

- Minutes of BQ advisory committee meetings
- Suggestions or complaints and the action taken on them
- Projected BQ improvements
- BQ improvements accomplished
- New residents
- Ideas to improve living standards or solve problems

HANDLING CASH.— Your duties may involve handling cash receipts at the front desk. Any funds entrusted to your care must be handled strictly according to the established procedures without taking any shortcuts. This reduces the chance of error or shortage. As a cashier, you are held responsible for all funds in your custody. You are more likely to be involved with collecting cash for service charges. These duties normally include the following:

- Obtaining and counting the change fund
- Operating the cash register
- Receiving payments and making change
- Cashing checks (if authorized)
- Counting cash receipts
- Preparing the daily activity record

Change Fund.— A change fund is an amount of money advanced to a cashier for use in making change. Each cashier signs a receipt for the total value of the change fund and is responsible for it. It is very important, therefore, that you count the change fund before signing for it to make sure no error has been made.

The cashier normally receives the change fund before going on duty and returns it with the receipts when relieved. When the change fund is passed to a relieving cashier instead of being turned in with the cash receipts, the relieved cashier's cash receipt is documented on the Daily Activity Record, NAVCOMPT Form 2211 (fig. 10-5). Since the change fund is actually passed on to the relieving cashier, this fund is said to have "revolved."

The Cash Register.— Cash registers are normally used at each front desk location where the collection of money is a regular, daily occurrence. The use of a cash register is particularly desirable when written records are not made of each transaction. When a cash register

is not available or its use is not practical, a cashbox or drawer may be used. The following discussion applies to the use of cash registers. However, part of it also applies, with modifications, to the use of a cash drawer or cashbox for cash transactions.

A cash register should give years of service if it is not mistreated. Operating characteristics of the different makes and models vary widely, but most of them perform the same function.

In addition to keys for recording the amount of the transaction, special keys may be provided to indicate cash sales, paid out, and no sale. When more than one cashier uses the same cash register, special keys can be used to identify the cashier handling the transaction. One of the more important functions performed by the cash register is the accumulation of totals provided by its registers. Normally, a register is provided for each special key plus a grand total register. The registers are concealed by a locked cover that can be opened only by a key retained by the person designated to read the register. The register totals are gained by unlocking the cover and reading them visually or by printing out the totals on cash register tape.

A key also is provided to lock the cash register. This key should be held by the cashier. Whenever the cashier must leave the vicinity of the cash register, it should be locked. This will prevent access by unauthorized persons. The cash drawer of an empty cash register should always be left visibly open.

Special compartments are provided in the cash drawer for the various denominations of coins and bills. You may use whatever sequence you prefer in distributing coins and bills in the compartments, but be consistent. Also, different denominations of coins or bills should not be mixed in one compartment. If the coins and bills are mixed, making change will be more complicated and the chance for error will be increased. When new bills are received, a corner should be turned down on each bill to prevent them from sticking together. Checks and large bills may be placed in separate compartments or beneath the tray of the cash drawer.

Payments and Change.— As a cashier, you should develop correct habits for handling payments from patrons. You should use the following five steps when handling any cash transaction:

1. Count all money you handle carefully. This includes the change fund, the money you receive from customers, and any additional change you receive during the watch.

DAILY ACTIVITY RECORD NAVCOMPT FORM 2211 (REV. 3-72)				REGISTER NO.																																								
NAME OF DEPARTMENT		SIGNATURE OF CASHIER		DATE																																								
LINES 1 THRU 6 TO BE FILLED IN BY CASHIER	ITEM NO	ITEM	AMOUNT																																									
	1.	CASH TURNED IN (DETAIL BELOW - ITEM 20)	\$																																									
	2.	CHANGE FUND (-) (WHEN TURNED IN WITH RECEIPTS)																																										
	3.	REFUNDS (+)*																																										
	4.	CASH SALES																																										
	5.	CHARGE/COMMERCIAL CREDIT SALES																																										
PERSON VERIFY- ING CASH AND CHARGES WILL VERIFY LINES 1 2, AND 5 AND FILL IN LINES 7 THRU 11	6.	TOTAL SALES: SALES SLIPS OR TICKET NUMBERS THRU	\$																																									
	7.	CHANGE FUND																																										
	8.	CASH RECEIPTS																																										
	9.	TOTAL CASH VERIFIED (LINE 7 + 8 = 9)																																										
	10.	CHARGE SALES																																										
PERSON READING THE REGISTER WILL FILL IN LINES 12 THRU 18	11.	TOTAL VERIFIED (LINE 9 + 10 = 11)	\$																																									
	12.	CLOSING REGISTER READING																																										
	13.	OPENING REGISTER READING																																										
	14.	REGISTER AMOUNT (LINE 12 - 13 = 14)																																										
	15.	OVER-RINGS (-) AND UNDER-RINGS (+)																																										
	16.	REFUNDS (+) (TO BE USED WHEN REFUNDS ARE REFLECTED IN REGULAR REGISTER READINGS)																																										
	17.	ADJUSTED REGISTER READING (LINE 14 ± 15 + 16 = 17)																																										
	18.	CASH OVERAGES OR SHORTAGES (CIRCLE: OVERAGE OR SHORTAGE)	\$																																									
19. BREAKDOWN OF REVENUE (TO BE FILLED IN BY BOOKKEEPER)				20. DETAIL OF CASH TURNED IN (TO BE FILLED IN BY CASHIER)																																								
NAME OF ACCOUNT	ACCOUNT NO.	DEBIT AMOUNT	CREDIT AMOUNT	<table border="1" style="width:100%; border-collapse: collapse;"> <tr> <td rowspan="5" style="writing-mode: vertical-rl; transform: rotate(180deg);">COINS</td> <td style="text-align: center;">CENTS</td> <td style="text-align: right;">\$</td> </tr> <tr> <td style="text-align: center;">NICKELS</td> <td></td> </tr> <tr> <td style="text-align: center;">DIMES</td> <td></td> </tr> <tr> <td style="text-align: center;">QUARTERS</td> <td></td> </tr> <tr> <td style="text-align: center;">HALF-DOLLARS</td> <td></td> </tr> <tr> <td colspan="2" style="text-align: right;">TOTAL COINS</td> <td style="text-align: right;">\$</td> </tr> <tr> <td rowspan="5" style="writing-mode: vertical-rl; transform: rotate(180deg);">CURRENCY</td> <td style="text-align: center;">ONE'S</td> <td></td> </tr> <tr> <td style="text-align: center;">FIVE'S</td> <td></td> </tr> <tr> <td style="text-align: center;">TEN'S</td> <td></td> </tr> <tr> <td style="text-align: center;">TWENTY'S</td> <td></td> </tr> <tr> <td colspan="2" style="text-align: right;">TOTAL CURRENCY</td> <td></td> </tr> <tr> <td rowspan="3" style="writing-mode: vertical-rl; transform: rotate(180deg);">CHECKS/M.O.'S</td> <td style="text-align: center;">U.S. CHECKS</td> <td></td> </tr> <tr> <td style="text-align: center;">OTHER CHECKS</td> <td></td> </tr> <tr> <td style="text-align: center;">MONEY ORDERS</td> <td></td> </tr> <tr> <td colspan="2" style="text-align: right;">TOTAL CHECKS/M.O.'S</td> <td style="text-align: right;">\$</td> </tr> <tr> <td colspan="3" style="text-align: right;">GRAND TOTAL CASH TURNED IN</td> <td style="text-align: right;">\$</td> </tr> </table>	COINS	CENTS	\$	NICKELS		DIMES		QUARTERS		HALF-DOLLARS		TOTAL COINS		\$	CURRENCY	ONE'S		FIVE'S		TEN'S		TWENTY'S		TOTAL CURRENCY			CHECKS/M.O.'S	U.S. CHECKS		OTHER CHECKS		MONEY ORDERS		TOTAL CHECKS/M.O.'S		\$	GRAND TOTAL CASH TURNED IN			\$
COINS	CENTS	\$																																										
	NICKELS																																											
	DIMES																																											
	QUARTERS																																											
	HALF-DOLLARS																																											
TOTAL COINS		\$																																										
CURRENCY	ONE'S																																											
	FIVE'S																																											
	TEN'S																																											
	TWENTY'S																																											
	TOTAL CURRENCY																																											
CHECKS/M.O.'S	U.S. CHECKS																																											
	OTHER CHECKS																																											
	MONEY ORDERS																																											
TOTAL CHECKS/M.O.'S		\$																																										
GRAND TOTAL CASH TURNED IN			\$																																									
TOTAL		\$	\$																																									
* SIGNED REFUND VOUCHERS WILL BE ATTACHED REMARKS: (Use reverse side if necessary)																																												
SIGNATURE OF PERSON DESIGNATED TO READ REGISTER		SIGNATURE OF PERSON DESIGNATED TO VERIFY CASH AND CHARGES:																																										
NOTE: TO MAKE CORRECTIONS: LINE THROUGH ERROR. WRITE CORRECT AMOUNT ABOVE ERROR. INITIAL AND DATE. CORRECTIONS ARE MADE ONLY BY PERSON MAKING ERROR. NO CORRECTIONS WILL BE MADE TO LINES 1 THROUGH 6.																																												

Figure 10-5-Daily Activity Record, NAVCOMPT Form 2211.

2. Repeat aloud the amount of money handed to you, as well as the amount if sale. You will avoid the chance of becoming confused, or the chance of the customer being mistaken about the amount of money given to you, by doing this for every sales transaction.

For example, as the person hands you the money, you should say, "Thank you, that will be \$4.35 out of \$5."

3. Leave the amount received on the change plate until you count the change from the cash drawer so there can be no question about the correct amount. If

someone interrupts you or you forget, you will have the exact amount received in front of you just below the keys of the cash register.

4. Count the change twice—first as you take it from the cash drawer, and again as you give it to the customer. Start counting the change from the amount rung until you build up to the amount received. For example, if you ring up \$4.35 out of \$5, you would pick up a nickel and a dime from the drawer and count aloud, “four forty, four fifty,” and then pickup two quarters and count, “four seventy-five, five dollars.” Repeat this procedure as you count the change into the customer’s hand. If you or the customer finds an error in the count, take back all the change, make the correction, and then count the change correctly. Be very careful not to put the customer’s money into the cash drawer until you have counted out the change and the customer has accepted it.

5. Handle only one transaction at a time. Concentrate on one customer exclusively. Take money from only one person at a time. Ring up one sale at a time. Close the cash drawer after completing each transaction.

Cashing Checks.— Each facility sets up its policy for cashing checks. As a cashier, your first responsibility must be to thoroughly familiarize yourself with that policy. Usually it will specify which cashiers may cash checks and the maximum amount for which a check can be cashed. This limitation is necessary because most cashiers do not keep a large amount of cash in their cash registers. Additionally, cashing large checks may deplete the tush needed for making change.

When accepting checks, either in payment for charges or for cashing, you should observe the following rules:

- They should be written in ink or indelible pencil.
- They must be dated and signal
- They must not contain corrections or erasures.
- The amount shown in figures must agree with the amount written out.
- The information on the check should correspond with the personal identification.

Closing Out.— At the close of business or at the end of your watch, you must close out the cash register. The results of this closing out are shown on the Daily Activity Record, NAVCOMPT Form 2211 (Fig. 10-5).

The cashier fills in the heading of the form and completes item 20 and lines 1 through 6. The person verifying cash and charges verifies lines 1, 2, and 5, and then completes lines 7 through 11. The next step is to have the person designated to read the cash register fill in lines 11 through 18.

Supply Petty Officer

The supply petty officer (SPO) is responsible to the BQ officer for the procurement, custody, and issuance of linens and cleaning supplies. These responsibilities are further broken down in to the following particulars:

- Orderly issuing all cleaning supplies, furniture, and equipment for the BQs
- Processing requisitions for BPOs and placing bulk orders
- Maintaining usage data by accurately documenting issues of supplies
- Making sure proper issue/turn-in procedures are followed
- Ordering products that prove most effective and economical
- Controlling accountability, custody, and issues of linen
- Maintaining accurate linen inventory records
- Accounting for and replacing lost or worn-out linen
- Receiving and turning in linen to a cleaning contractor
- Maintaining an accurate inventory record of FF&E
- Maintaining accurate record for all assets (less cash) of the BQ for budget input

Building Petty Officer

The BPO is responsible to the BOQ or BEQ officer for the overall cleanliness, material condition, and operation of a specific building or area. The BPO has the following responsibilities:

- Periodically inspects individual rooms for cleanliness and material condition

- Acquires and provides necessary supplies and equipment to clean and maintain the quarters effectively
- Supervises assigned enlisted personnel and civilian custodial staff in all phases of cleanliness, maintenance, and operation of the BQ
- Conducts daily inspections of all common use areas to make sure they are clean, sanitary, and attractive in appearance and habitability
- Serves as a primary contact between management and residents—to solicit recommendations on building conditions and policy for improvements
- provides room status to the front desk
- Controls FF&E in assigned areas
- Operating assigned baggage storeroom(s)

Baggage Storeroom

At most BQs a baggage storeroom is maintained to store residents' unused baggage and personal property. The baggage storeroom may be the responsibility of the BPO or the front desk.

Of vital importance is the security of the personal property of the occupants and management's responsibility to safeguard these items. Strict account ability must be maintained to ensure this control. The system for operating the baggage room must afford the maximum security for the residents' possessions. Conversely, it must demand the minimum of time and work for the BPO or appointed custodian to allow this person to fulfill all other BPO duties. Local commands should provide guidelines showing what can and cannot be stored in the baggage room. Other than unsafe items such as flammables, corrosives, and firearms, residents should be permitted to store any excess gear in the baggage room.

Hours of operation should be designed to afford the residents ready access to the baggage room and the hours should be posted and widely publicized. To provide the strictest security possible, stringent procedures for access must be enforced. The BPO or appointed custodian should be the only staff member to have general access to the baggage room. Do not give residents the keys to the baggage room under any circumstances, as that would compromise security. Baggage room keys will not be on the master key ring.

The baggage key must remain in the custody of the custodian.

The following procedures should be used to check items into the baggage storeroom:

- A standard, sequentially numbered, three-part baggage storeroom form (fig. 10-6) is used. Identification is established by the sequential numbers in conjunction with the name and room number of the resident. The top part of the form is attached firmly to the item to be stored. The middle part is stapled to the upper left-hand corner of the registration card. The bottom part is given to the resident.

- If items are to be stored in a container, a joint inventory must be taken by the resident and the front desk or BPO. Even if the container is empty, an inventory should be taken, indicating an empty container. A copy of the inventory (fig. 10-7) must be placed in the container and a copy given to the resident.

- Residents checking in after hours or on weekends must keep items for storage until the next working day that the BPO is present.

- The following procedures must be used to check items out of the baggage storeroom:

- Check-outs are only made during normal hours of operation.

- Residents wishing to check items out for weekends must do so on or before the BPOs last working day of the week.

01015	
NAME _____	#1 Baggage
BILLETING SPACE _____	
----- 01015	(PERFORATION OR "CUT HERE" LINE)
NAME _____	#2 Front desk
BILLETING SPACE _____	
----- 01015	(PERFORATION OR "CUT HERE" LINE)
NAME _____	#3 Resident
BILLETING SPACE _____	

Figure 10-6.—Baggage storeroom form.

SAMPLE FORMAT

RESIDENT PERSONAL BAGGAGE INVENTORY SHEET

NAME _____ DATE _____

BILLETING SPACE _____

ITEM NAME MAKE COLOR CONDITION

RESIDENT'S SIGNATURE _____ BPO'S SIGNATURE _____

Figure 10-7.—Resident personal baggage inventory sheet.

- Ownership of the items should be verified by using the resident's claim check and military Identification Card, DD Form 2N. If the resident does not have the claim check, the stub attached to the space status display should be used to verify ownership. An exception to the check-out procedure will be made only during emergencies. The front desk should maintain a key to each baggage room in a sealed, signed envelope kept inside the emergency key locker for this purpose. The NAVPERS 15606 discusses the emergency key control locker under key control procedures in chapter 12.

- The BPO must maintain a log of items stored in the baggage room. The log should list the tag number, item type, date received, and date(s) resident reopened

and inventoried items. It also should list the date the resident removed items from storage.

- Upon relief, the relieving BPO must conduct an inventory with the current BPO before assuming the responsibility for the baggage storeroom. The information for this inventory may be obtained from the space status display.

CARE OF QUARTERS

Care of quarters ashore is really not too different from that required aboard ship. On shore stations, a room attendant will normally be employed to perform bed-making and similar hotel services. In fact, quarters maintenance ashore is usually easier because the spaces

are less crowded, there are fewer difficult places to clean, and better use can be made of labor-saving equipment.

A well-equipped room service cart will save many steps because all required supplies can be taken to the room in one trip. In addition to carrying all cleaning equipment, the cart should have a place for clean linens, a bag or hamper for soiled linens, and a bag or container into which wastebaskets can be emptied.

Routine care is normally covered by cleaning schedules that list the jobs that are to be done daily and weekly, and personnel are assigned specific cleaning responsibilities. A room inventory should be taken with each daily cleaning using a checkoff list. Any missing items are recorded on the list, and it is referred to the BPO for appropriate action.

Custodial Force (Military or Civilian)

The custodial force is responsible to the BPO for the cleanliness of the BQ. Specifically, the custodial force has the following responsibilities:

- As directed by the BPO, and depending upon the type and configuration of the quarters, cleans all the common use areas and the outside areas of the BQ daily
- Assists the BPO in maintaining the BQ in an appropriate level of safety, cleanliness, and comfort for the occupants
- Reports any complaints or suggestions directly to the BPO received about the BQ. Reports any known or suspected breaches of regulations or discipline within the BQs

Equipment and Supply Rooms

Large amounts of cleaning equipment are ruined and become useless through the simple failure to provide for their proper storage. Brooms, foxtails, and radiator brushes quickly become useless if they are stored with the weight resting on their fibers. They should be suspended from wall mounts. Buffer brushes must be removed from the buffers when not in use. The practice of storing buffers with the brushes still attached soon crushes the fibers. This results in erratic buffer operation and requires the early purchase of new brushes.

Close supervision of the custodial cleaners is needed to make sure only correct cleaning agents are used for each job, and only the prescribed rations are

used when mixing products with water. The BQ staff should premix cleaning solutions before their use to avoid unnecessary waste. Swabs should be marked as to specific use (that is, strip, wax, or rinse) and not interchanged. They should be stored with the strands up, from wall mounts, to allow them to dry properly.

Usage data compiled for the cleaning supplies consumed in each building is a valuable tool. It can be used for both locating areas of waste and determining which cleaning agent is most effective.

High and low limits should be established to make sure adequate supplies are always on hand. The person in charge of the bulk storeroom area should maintain a record of receipts, issues, and inventory.

ADMIRAL ZUMWALT AWARD FOR BQ MANAGEMENT

The Secretary of the Navy established the Admiral Elmo R. Zumwalt Award for BQ Management. Its purpose is to recognize those commands whose Navy bachelor quarters excel in providing responsible, well-managed, and habitable living conditions for naval personnel. Complete details of this award program are contained in the *Navy Bachelor Quarters Manual*, NAVPERS 15606.

The Admiral Zumwalt Award Program is sponsored by the Secretary of the Navy to indicate the high degree of importance attached to the living conditions of Navy men and women.

BUPERS administers the program, and provides suitable awards to be presented by the Secretary of the Navy to the three finalists in each of the following competitive categories of BEQ and BOQ management operations:

- Jumbo - 2,500 or more total spaces
- Large - 1,000 or more total spaces
- Medium - 300 to 999 total spaces
- Small - up to 299 total spaces

A space is defined as an increment of 72 square feet net (living area) for E-1 through E4 trainees and recruits and of 90 square feet for all other enlisted rooms and open bays.

TRAINING

An effective training program in the management and administration of BQs is essential to establishing

and maintaining proper standards. Before making any person responsible for a task, you should be sure he or she knows how to perform it correctly. Training takes time and patience, but it pays off and failure to train can be costly.

On-the-job training is used primarily for teaching skills, and may be the best method for teaching complex operations. It is usually accomplished under informal conditions and with small groups. In BQ training situations, it should take place where the job is actually performed.

Ideally, on-the-job training should be preceded by more formal classroom training to give the trainee a thorough grounding in the subject matters. Lectures or lecture-demonstrations may be used to familiarize the trainee with the basic operations and to develop the proper trainee attitudes. If the preliminary training is adequate, the on-the-job training can progress quickly to more advanced skills. In-depth training requirements are identified in NAVPERS 15606.

BACHELOR QUARTERS MANAGEMENT SCHOOL

CNET has established the BQ management class C school. This school is located at both the Service School Command (SSC), San Diego, California, and the Fleet Training Center (FTC), Norfolk, Virginia. This school is 3 weeks in length and is listed under course number A-800-0021 in the *Catalog of Navy Training Courses*, NAVEDTRA 10500.

The purpose of the school is to provide prospective BQ managers with the principles of management and organization necessary to provide efficient operation and maintenance of BQs, thus, enhancing living conditions for bachelor military personnel. The BQ management school is for enlisted members E-5 through E-9; officers W-1 through O-3; and civilians of comparable grades. A Navy enlisted classification (NEC) is awarded to personnel who successfully complete the course. The school's curriculum includes the following topics:

- Orientation
- Principles of management and organization
- Occupancy criteria and eligibility
- Facility maintenance and custodial services
- Front desk procedures

- Procedures for maintaining supplies and equipment
- Safety and security
- Inspections
- Administration of contracts and funds
- Budget planning
- Search and seizure procedures

BACHELOR QUARTERS MANAGEMENT ASSISTANCE and INSPECTION TEAM

The CNO has established the MAIT, located in Washington, DC. This team consists of highly qualified senior MS personnel who are specially trained to help commands improve BQ management so that living conditions may be improved and operational costs reduced. The team will inspect each command approximately every 3 years.

The team will normally conduct the inspection in the following manner:

- Introduction—the team meets the CO, BQ officer, and staff.
- Inspection—the team examines every facet of the quarters operation including living areas, front desk, supply operation, and the relationship with other command departments.
- Training—as time permits, the team provides training to the quarters staff tailored to the command's needs.
- Point-by-point brief—the BQ officer is briefed in detail on the team's findings during the inspection.
- Exit brief—the CO is briefed on the highlights of the team's findings and recommendations, plus the training conducted.

These procedures may be changed to meet local conditions, but the team will always strive to conduct the visit with the smallest possible disturbance to the command's routine.

BUPERS will provide a written report of the findings and recommendations of the MAIT to the host command via the major claimant. The host command will advise PERS-671 in writing of actions taken on the recommendations and keep copies of the recommendations and actions taken. They also will

provide copies of both to the inspectors on subsequent command inspections.

The following list contains some of the most important publications that are useful in setting up a training program:

- NAVPERS 15606, *Navy Bachelor Quarters Manual*
- NAVFAC MO-125, *Custodial Services Manual*
- NAVPERS 15159, *Manual for Messes Ashore*, chapter IV

- NAVSO P-3520, *Financial Management Policies and Procedures for Morale, Welfare, and Recreation Programs*
- NAVEDTRA 10119-B1, *Navy Customer Service Manual*

The BQ MAIT also conducts assist visits as scheduling permits. Funded by the requesting activity, an assist visit is conducted in much the same way as inspections with more emphasis placed upon training. The type of training provided is based upon the weaknesses found at the command.

CHAPTER 11

FIELD KITCHENS

At some point you may be assigned to an amphibious or naval mobile construction battalion and accompany it ashore as a member of a landing party. A landing party usually consists of 100 personnel and has 2 or 3 MSs assigned. As an MS, you should be prepared to provide food for those troops you accompany. You also will probably become involved in locating the proper site for the field kitchen and in its construction. This chapter will present to you the skills needed to accomplish the following:

- Select field kitchen sites
- Plan a layout of field kitchen facilities
- Unpack and set up kitchen tents
- Unload and arrange field kitchen equipment in the kitchen tents
- Clean and reload field kitchen equipment
- Pack and store field kitchen tents

FIELD KITCHEN SIGHT SELECTION AND LAYOUT CHARACTERISTICS

Naturally, you will want the best available site for your field kitchen. The general area in which personnel will be fed is normally determined by the shore party commander. You, the MS, may have to recommend the selection of a particular site.

PLANNING THE LOCATION

There are several details to look for when you pick a site. Figure 11-1 lists the characteristics of a good field site. It also explains why these characteristics are important.

Type of Terrain

If there is danger of bombing or other enemy action, select a location that provides good natural cover and is well shielded from observation.

High, dry ground near a slope that provides good drainage is desirable. A good water supply should be nearby, with an access road for kitchen traffic only, if possible. Your galley should be at the proper distance away from the heads.

CHARACTERISTIC	IMPORTANCE
Good natural cover	Shields troops from the enemy aerial observation, protects them from sun, heat and cold winds
Good access roads	Lets supply trucks move freely
High and dry ground near a protected slope	Ensures good drainage and protects you from the wind
Enough space	Eliminates crowding of the troops and facilities spreading out the equipment so personnel can work efficiently
Near source of potable water	Used in preparation of foods (water point) and beverages
Sandy or gravelly soil	Lets excess water seep away and helps soakage pits and trenches work well

Figure 11-1.—Characteristics of a good field site.

Water Supply

You should regard all water in the field as contaminated until bacterial analysis reveals it to be potable. It may become contaminated during distribution and storage. Consider all untreated water unsafe until a medical representative approves it for use. During the initial phase of amphibious operations, each unit may carry its own water or depend on a local supply. The local supply of water must be disinfected and placed in sterilized lyster bags (36-gallon canvas bag) or canteens.

The responsibility for the adequacy and safety of the water under these conditions normally falls largely on the unit medical officer. However, you should be familiar with chapter 5, "Water Supply Ashore," of the *Manual of Naval Preventive Medicine*, NAVMED

P-5010. This chapter discusses in detail the following: water supplies, sources of water, water analysis, standards and purification of water, and the *Standard organization and Regulations of the U.S. Navy, OPNAVINST 3120.32*, in case medical personnel are not available. Remember that none of the methods of disinfecting water contained in these publications destroys radioactive substances or chemical poisons.

GROUNDWATER.— Groundwater from springs or wells is usually better than surface water. When you use water from a ground source, be sure it is a safe 100 feet or more from sources of contamination. Some sources of contamination are heads, septic tanks, and cesspools. In limestone ground formations, the distance may need to be much greater. Wells and springs should be constructed to exclude surface water and

high-groundwater infiltration. Well and spring sites should not be subject to flooding.

SURFACE WATER.— Surface water is water from rivers, lakes, streams, and ponds. When you must use water from a surface source, take it from a point well above and away from sewer outlets. Avoid places where refuse drains into a river, stream, or lake, and oily areas where wastes and drainage may make the water unpalatable or unfit for use. Always choose the clearest water possible; the clearer the water, the easier it is to disinfect and the better its appearance will be. Clearness, however, is no guarantee of safety. All surface water must be treated.

Clean water receptacles daily with boiling water and rinse with a solution of potassium permanganate (one-third of a teaspoonful of potassium permanganate

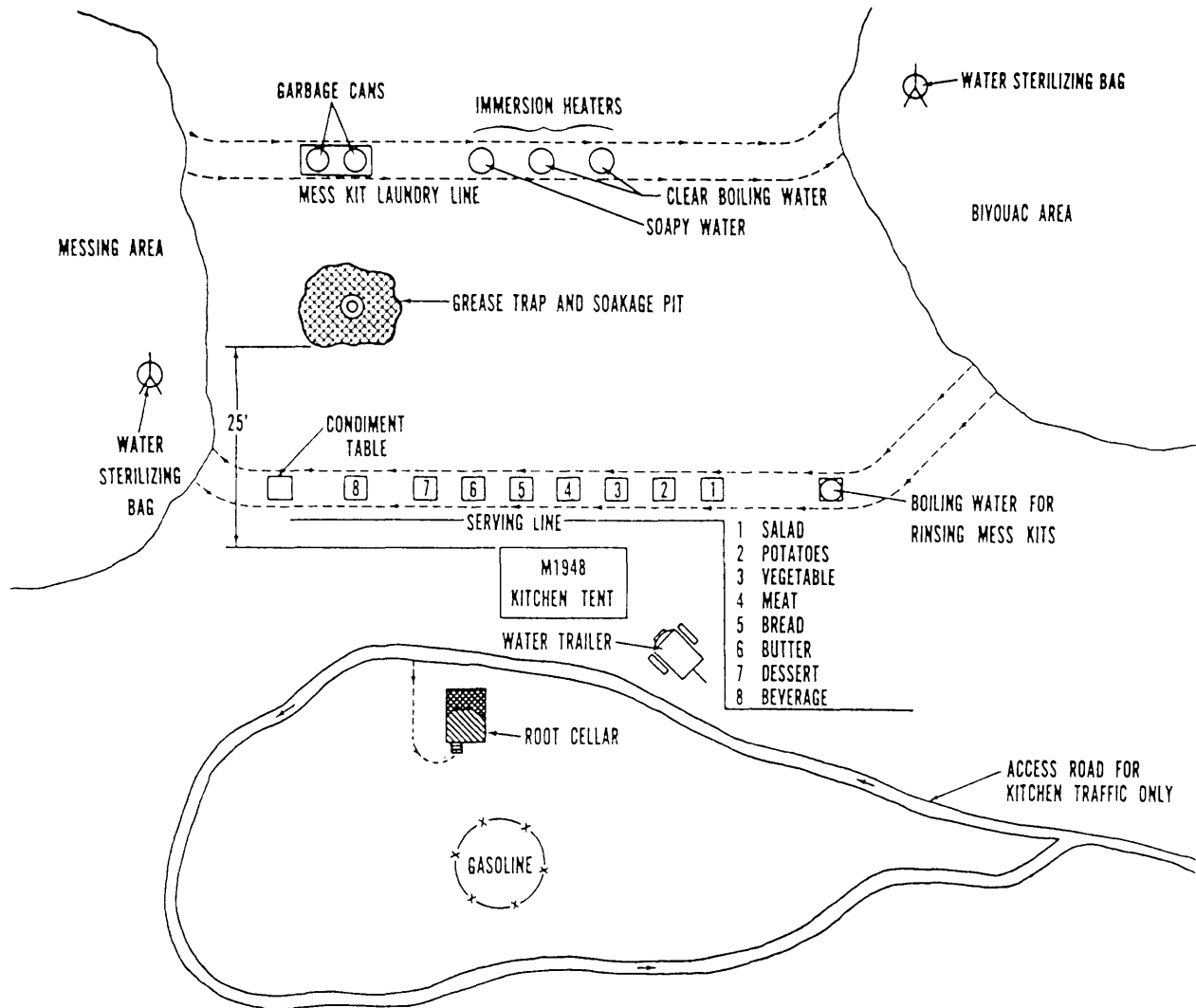

Figure 11-2.—Rear area layout for field feeding.

to 1 gallon of water). You also can use a solution of chlorinated lime and water for this purpose. The formula is 1 part lime to 1,000 parts water.

PLANNING THE KITCHEN LAYOUT

A kitchen layout shows you where to place waste disposal facilities. It shows a smooth traffic flow through the serving line and mess kit laundry line. A smooth traffic flow allows the troops to get away from the area easily if they must move fast.

Make sure all latrines are at least 100 feet from the nearest natural water source and at least 100 yards from foodservice areas.

A layout for a rear area feeding situation is shown in figure 11-2.

Storage of Food

If you are to stay in one place for several days or more, you must provide storage facilities. If you do not have mechanical refrigeration in temporary camps, you may place food in water containers and put these containers in springs or streams.

It is also possible to keep food items in the ground for a short time. This takes advantage of the insulating and cooling qualities of the moist earth beneath the surface. This also protects stored food from the elements. Dig a hole, line it with burlap sacks and boards, then place the food, in its original container, in the hole. Once this is done, cover it with soil, straw, or leaves.

For small amounts of food you can use a food box screened with wire or cloth netting suspended from the branch of a tree. This is called a swinging food box (fig. 11-3). The oil cup keeps insects from crawling down the wires to the box.

The root cellar has one of the advantages of a mechanical walk-in refrigerator. It makes foods easier to handle, especially when the foods are in bulk form. The height of the root cellar permits personnel to carry foods in or out of the cellar without stooping or bending.

You can construct a root cellar if the terrain is hilly and a location is found that slopes upward at a sharp angle. The size of the excavation will vary according to the storage space required. Once the excavation is complete, reinforce the sides and line with waterproof material. Level the floor, cover it with dunnage, and grade away the entrance. Use heavy boards or logs to form the roof, then cover with a tarpaulin. Provide top

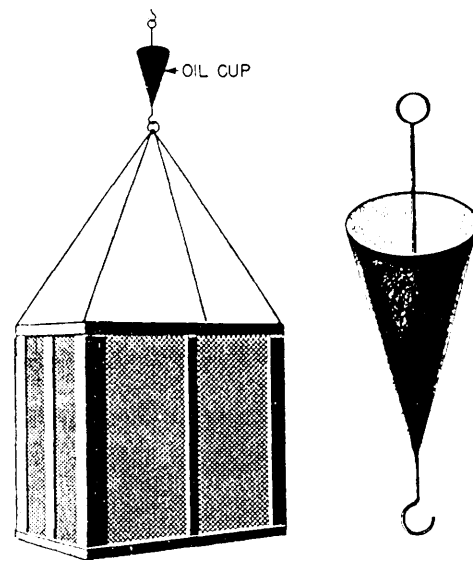

Figure 11-3. Swinging food box.

ventilation by making openings at the tops of the cellar sides. Fit the entrance with a door large enough to permit easy passage for personnel carrying food in the largest expected bulk form. Always keep the door closed and covered with a canvas flap when it is not in use. Fill all the spaces between exposed logs or boards with wet earth.

You can construct an underground food box when the terrain is flat or when you need more space. The simplest kind consists of a packing box and a hole dug to fit it. After you dig the hole, lower the box into it. Then shovel loose earth into the spaces between the box's outside walls and the sides of the hole. Next, pack this earth into a tight fit. Fashion the top of the box into a door. Line the underside of the top with canvas or some similar material. This will help make it airtight. (See fig. 11-4.)

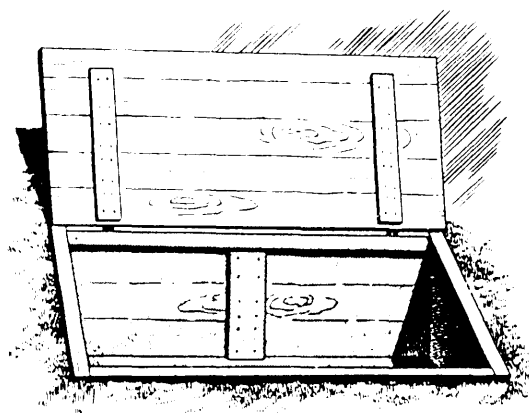

Figure 11-4.—Underground food box.

To make a double-walled type of food box, use one large packing box and one that is slightly smaller. Drill holes in the bottom of the larger box and cover its outer walls with waterproof paper or some similar material. Convert the top into a door with hinges. Then dig the pit slightly larger than the box and fill the bottom with about 4 inches of stone or gravel. Sink the box inside the larger one, allowing for a space of from 3 to 4 inches between the sides of the two boxes all the way around. Stuff sawdust, straw, or grass between the two boxes to serve as insulation. For best results, always keep this material damp. Camouflage the box, when necessary, by placing a wet blanket over it and covering the blanket with leaves.

The natural refrigeration provided by both the root cellar and the food box is supplemented by the thawing of the frozen meats within the storage space. Frozen meats will help refrigerate other perishables during the period required for them to thaw. If ice is available, you can partition off one end of the food box to form an ice compartment.

Garbage Disposal

Garbage is best disposed of by burying or burning. To bury garbage, dig a trench 4 feet deep or more. Dump the garbage into the pit, packing it down in layers. Then cover the exposed layer with a few inches of dirt each day. When you abandon the garbage site, cover it with a minimum of 2 feet of mounded earth.

To incinerate garbage, you must first remove all excess moisture. The cross-trench incinerator (fig. 11-5) provides one of the best methods of burning garbage. To construct such a trench, dig two trenches 8 feet long, 1 foot wide, and 1 foot deep, that cross at their centers. The

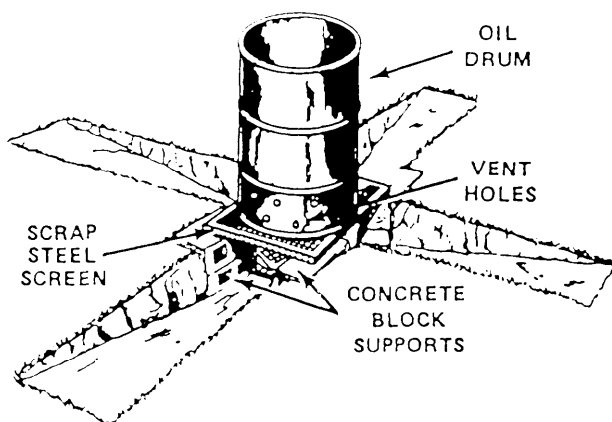

Figure 11-5.-Cross-trench incinerate.

bottom of each trench should taper up to the level of the ground toward the ends. A grate made of a piece of scrap iron or pipe about 24 inches long is built over the centers. At the intersection of the trenches, build a coal or wood fire. When the fire has become hot enough, add rubbish or drained garbage as fuel. This incinerator functions best if three of the four sides of the trenches are blocked off, with the open side facing into the wind.

This type of cross-trench fire can be used for cooking as well as incinerating. Two cross-trenches provide enough cooking facilities to prepare meals for 100 people and six of them provide enough cooking facilities to prepare meals for 500 people.

To dispose of cans, you can wash them and use them as substitutes for cooking and eating utensils. You also can open both ends, flatten them, and bury them with the garbage. Glass jars also can be used as substitute eating utensils. When disposing of glass jars, break them up and bury them with the garbage.

Liquid wastes, such as grease, may be burned or buried with the garbage. The exception is any usable grease that can be used for cooking. Other wastes are best disposed of in the soakage pit (fig. 11-6). This pit should be at a minimum of 25 feet from the kitchen area.

FIELD KITCHEN TENTS

This section of the chapter presents you with the knowledge required to unpack and setup a field kitchen tent. You also will become familiar with the procedures used for packing and storing tents once field mess operations are complete.

The general-purpose medium (GPM) tent (fig. 11-7) is designed for field kitchen use. This tent is rectangular and pole supported. It consists of cave poles, door pies, center upright poles, a ridge pole, and a liner. The general specifications are as follows:

Ridge height (top)	10 feet
Eave height (outer perimeter)	5 feet 6 inches
Length	32 feet 8 inches
Width	16 feet
Floor area	512 square feet
Tent weight	269 pounds
Liner weight	100 pounds
Poles and pins	200 pounds
Total weight	569 pounds

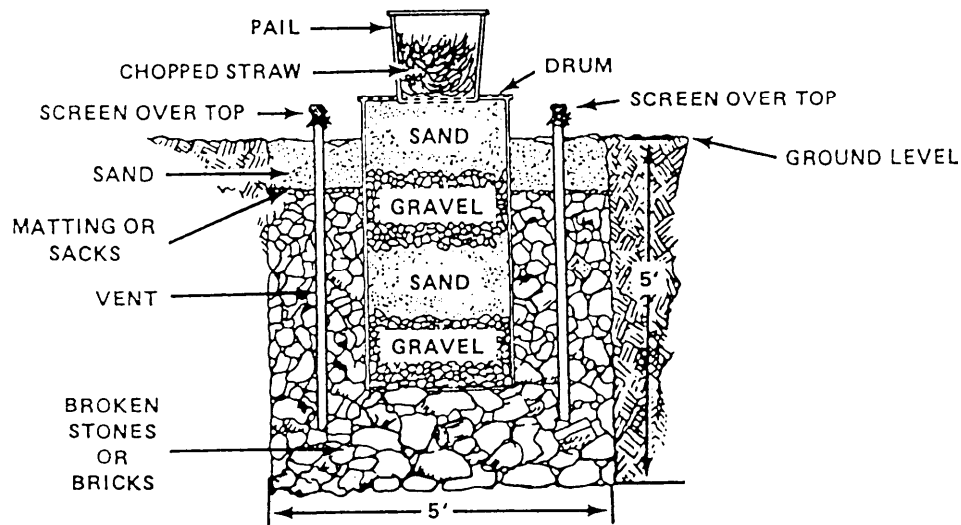

Figure 11-6.—Soakage and grease trap.

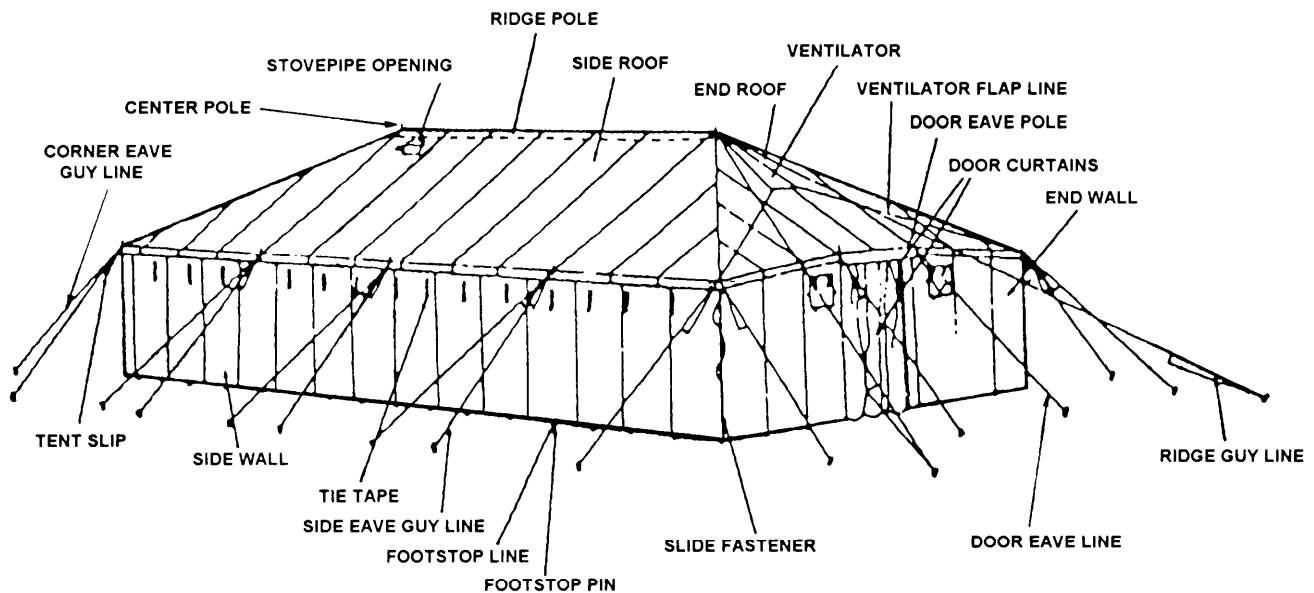

Figure 11-7.—General-purpose medium tent.

UNPACKING THE TENT

You are now somewhat familiar with the GPM field kitchen tent specifications and parts. We will now discuss the preparation for pitching the tent.

Preliminary Procedures

You should first make sure the selected area for the tent is on level ground and is free of projecting roots and rocks. When conditions permit, pitch the tent away

from natural elevations such as hills or tall equipment that might obstruct a draft through the tent stack

Remove the tent from its cover and spread it on the ground in a rectangular position with the sides extended.

Tent Components and Inspection

On the window flap located at one end of the tent will be a flap stop that reads Care and Maintenance. This panel contains an inventory list and erecting instructions. Use this to make certain all items are present and in serviceable condition.

It is very important that you inspect and inventory the parts both before erecting and after disassembling the tent. Tent disassembly is discussed later. The component and maintenance checks consist of the following:

- Tent body. Inspect for abrasions, mildew, holes, poor condition of previous repairs, broken stitching, evidence of leaks, and low fabric tensile strength.
- Tent lines. Check the tent lines for frayed or raveled ends and for broken strands.
- Tent poles. Check poles for cracks, splinters, and damaged metal parts.
- Tent pins. Check pins for breaks and cracks. There are twenty-eight 24-inch pins and forty-eight 16-inch pins.
- Tent hardware. Check hardware for rust, looseness, damage, and missing hardware.
- Tent cover. Examine cover for rips, mildew, broken stitching, frayed tie lines, and loose or missing grommets.
- Slide fasteners. Inspect for damage and freedom of movement. Lubricate when slide fastener is hard to move up or down.

SETTING UP THE TENT

At this point, you have selected an appropriate site for the tent. You are also familiar with the tent components and have made certain all items are present and in serviceable condition. Now you can begin to set up the tent.

When you are setting up the tent, use only tent parts and accessories for their intended purpose.

Component Assembly

You should begin to construct the tent by first assembling the poles. The tent has 1 ridge pole, 2 upright-center poles, 4 corner wall poles, 4 upright door poles, and 10 cave poles.

The ridge pole comes in three sections. Two metal bands allow you to join these sections. Tighten the four bolts that go through the bands to further secure these sections.

The two upright-center poles (10 feet 3 inches) come in two sections. To assemble the upright-center

poles, insert the end of the section without the band into the section having the metal band.

Raising and Securing the Tent

Due to the extreme technical nature of this process, the instructions that come with the equipment should be followed. Remember, these instructions should be on the window flap at one end of the tent under the Care and Maintenance heading. General instructions also may be found in the *Marine Corps Combat Feeding Workbook*, P-MCBLC 1179 (Rev. 12-91). If instructions are lacking, find a service member with enough experience to direct the raising and securing processes.

The following are some safety points to observe when erecting the tent:

- When lifting the tent, start in the correct squatting position and use your legs to avoid back injury.
- When working near frame hinges, be careful to avoid pinching your hands or fingers. Do not hold the hinge at the ridge or cave location.
- Do not use the Yukon stove (M1950) in the expendable modular tents.
- Raise and lower the entire side of the tent smoothly and evenly to avoid damaging the frame.
- Make sure to leave enough air space between the tent wall and foodservice equipment. When the M2 burner units are lit, they get hot. Frequently check the tent wall for heating while using the M2 burner units. Move the M2 burner units further away from the tent wall if necessary. If they are too close to the tent wall, they could ignite the tent.
- Do not step on tent components.
- To avoid damaging the tent frame, do not twist or turn it when handling.
- Clear and level the ground before installing the floor. Sharp objects or ground depressions can damage the tent floor.
- Be careful when moving or storing tent components to avoid damaging the fabric.
- If using an M1941 stove, make sure to tie the stovepipe flap securely with the two tie tapes provided.
- Remember that under high wind conditions extra personnel are needed to safely erect or strike the tent.

FOLDING AND STORING THE KITCHEN TENTS

The striking or disassembling of the kitchen tent is too technical to be explained in this manual. However, you will find these striking procedures in the *Marine Corps Combat Feeding Workbook*, P-MCBLC 1179 (Rev. 12-91). Also, the assistance of a service member having such experience would be helpful. Once disassembled, the tent must be properly folded and stored.

Folding the Tent

Once the poles have been disassembled and pins and lines removed, you can fold the tent. Close and secure doors and stovepipe openings. Then open the corner slide fasteners.

Spread the tent out flat with the outside up. Then, coil the guy lines and place them on the tent roof. Fold the end walls and the side walls over the cave line on the tent hood. Sweep the dirt from the tent after each fold. Next, fold the ends of the tent toward the center, making 6-foot folds. Finally, fold the two remaining 6-foot folds from each end of the tent together.

Storing Instructions

Most tents are mildew resistant. This does not mean that they are not subject to mildew. Under warm and damp conditions, especially in tropical jungle areas, mildew can ruin tents. This may occur in a few days if proper care is not taken. To prevent mildew, the following precautions should be taken:

- Never fold or roll a wet tent. Be especially sure the seams and edges of the tent are dry and clean.
- Before storing, dry the tent by hanging it up off the ground in bright sunlight. If necessary, you can dry a tent indoors. This is done by hanging it in a well-ventilated place, high enough to suspend the tent off the floor.
- Do not drag the tent along the ground while transporting or allow it to come in contact with the ground while in storage.

Be careful in handling pins and poles to see that they are not broken or otherwise damaged. When transporting or storing, keep pins and poles separate from the tent. Clean and dry all pins and poles before storing.

Inspect all lines before storing. The stability and safety of the tent may depend on the condition of the various lines used. Deterioration in the lines is of two kinds: physical and chemical. Surface wear or internal friction between fibers causes physical damage. Exposure to weather conditions and acids causes chemical damage. To prevent damage to tent lines, observe the following rules:

- Keep lines clean. If lines become dirty, wash them in clean water and dry thoroughly.
- Dry lines properly after exposure to dampness. Lines are best dried when hung loosely between two trees or other objects so they do not come in contact with the ground
- Store lines properly in a dry, unheated building or room with free air circulation. Place lines in loose coils off the floor on wooden gratings or hang them on wooden pegs. Never store lines in a small confined space without air circulation.

FIELD KITCHEN EQUIPMENT

Normally, you will have either a gasoline field range outfit or a small detachment cooking outfit, plus immersion-type heaters for cans and tank trailers. These will make it possible for you to cook and maintain sanitary standards almost as well as you can in a galley aboard ship.

FIELD RANGES

Gasoline field range outfits are the most satisfactory appliances available for preparing meals in the field. The armed forces now use model M59. Chapter 10 of the *Basic Doctrine for Army Field Feeding, FM 10-23*, covers the operation of the model M59 field range. *Operator, Organizational and Direct Support Maintenance Manual including Repair Parts and Special Tools List for Range Outfit Field, Gasoline, Model M59*, TM 10-7360-204-13&P, covers the maintenance and repair of model M59. See figure 11-8 for an illustration of the M59 range. One field range is adequate for 50 personnel or less. With two ranges, you can cook for 50 to 100 personnel. With three ranges, you can cook for as many as 225 people.

The gasoline field range outfit is designed to provide a complete outfit adaptable to the different requirements of field operations. The outfit consists of a cabinet with a burner unit, accessory outfit, and necessary cooking utensils (fig. 11-9). The outfit is portable and can be operated while in transit.



90.86

Figure 11-8.-M59 field range.

The range outfit can be used for boiling, roasting, frying, and griddle cooking and can be adjusted to work as a bake oven. Some baking can be done in the covered roasting pan or in the cake pan placed inside the covered roasting pan. Pies bake well in the roasting pan alone. However, for all other baked foods, you should use the cake pan. If you do a great deal of baking with the range, make the necessary adaptation.

For complete information on safety precautions operating and maintenance instructions, basic issue items lists, and maintenance allocation charts, you should refer to the applicable Army technical manual (TM). Be sure you have the appropriate TM for the particular range model (for example, M59) that you are using.

Operation of the burner unit used on the model M59 field range is discussed next.

Preheat Period

When you are lighting the M2 burner unit installed in the M59 field range, follow these procedures in the order listed. (See fig. 11-10 for the part number in parentheses.)

1. Remove the burner unit from the cabinet and take it to a well-ventilated, outside area.
2. Close the preheater valve (6) and the flame (generator) valve (9).
3. Stand the unit in a vertical position and loosen the fuel filler cap (12) by turning counterclockwise, slowly releasing air pressure.
4. Fill the tank until fuel can be seen at the base of the fuel filler cap (12). **CAUTION:** Do not overfill!
5. Install and tighten the fuel filler cap (12).
6. Remove the air valve cap (5). Place the unit in a horizontal position and attach the hand pump to the air valve (5).
7. Pump until the air pressure gauge (11) reads 10 to 20 pounds.
8. Rotate the preheater orifice cleaner control lever (7) several times to clean the preheater orifice; the handle should be pointing down when you are finished.
9. Place a lighted match near the preheater burner head (3) and open the preheater valve (6) one-fourth of a turn.

10. Allow the preheater burner head (3) to burn for 30 seconds after ignition or until the flame burns evenly. Then turn the preheater valve (6) counterclockwise until it is completely open.

11. Allow the preheater burner head (3) to burn until the full length of the generator (1) is hot to the touch.

12. Set the air shutter handle (8) in a half-open position.

Conversion Period

Turn the flame valve (9) slowly counter-clockwise to the open position. The burner should ignite before the valve is completely open. Adjust the air shutter level with the air shutter handle (8) until the burner flame color is sea green. Turn the preheater valve (6) clockwise. The normal operating pressure is 10 to 20 pounds.

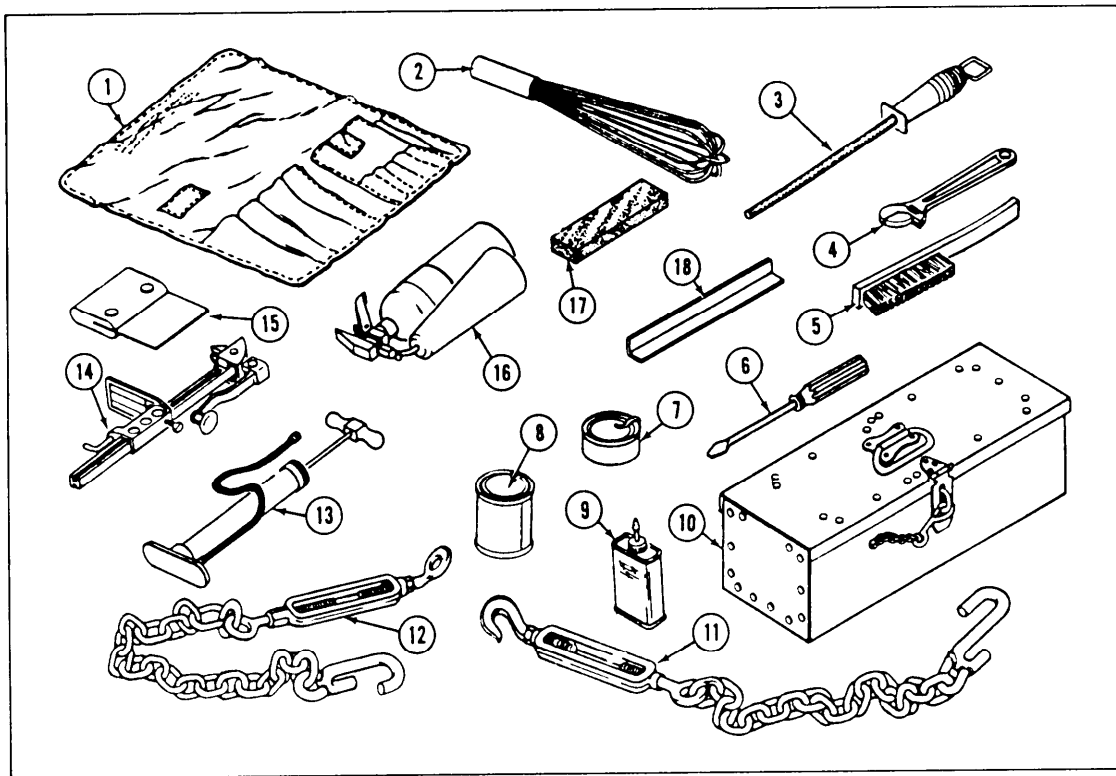

- | | |
|----------------------------------|-----------------------------|
| 1. Cutlery roll | 10. Chest tool |
| 2. Egg whip | 11. Chain, tie-in, left |
| 3. Butcher's steel | 12. Chain, tie-in, right |
| 4. Wrench | 13. Pump |
| 5. Wire brush | 14. Can opener |
| 6. Screwdriver | 15. Scraper |
| 7. Lid of graphite can | 16. Fire extinguisher |
| 8. Graphite (antiseize compound) | 17. Sharpening stone |
| 9. Lubricating oil | 18. Burnerhead slot cleaner |

Figure 11-9.—Accessory outfit for M59 field range.

Turning Off Burner Unit

Extinguish the flame on the main burner by closing the flame valve (clockwise) all the way.

Safety Precautions

Obey the following safety rules:

- Never refuel a hot unit.
- Do not remove air pressure while the unit is burning or hot.
- Do not open the fuel filler cap while near open flames.

- Assign a specific person the responsibility of constantly checking the air pressure gauge reading. Do not operate beyond 30 pounds of pressure.
- Do not tighten fittings while the burner is in operation.

SMALL DETACHMENT COOKING OUTFIT

The small detachment cooking outfit consists of a stove and the necessary attachments and utensils required to prepare rations for 15 to 40 personnel. The outfit is designed primarily for outdoor use by isolated detachments. If used indoors, a smokestack provided with the outfit must lead outside to avoid carbon

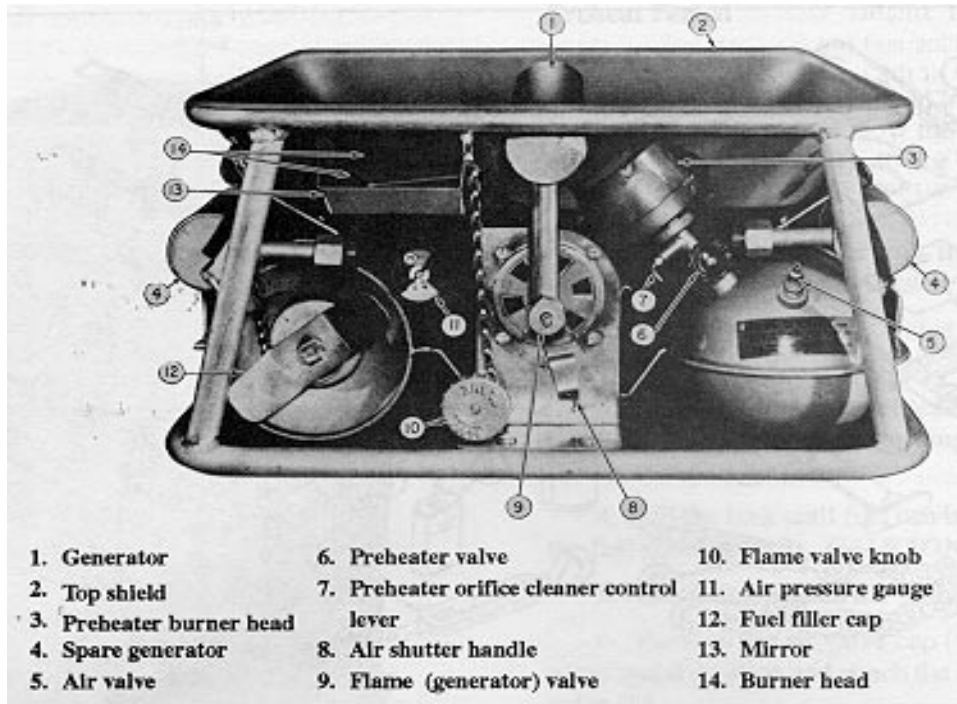

Figure 11-10.—Burner unit and parts.

90.91

monoxide poisoning. The outfit is divided into two sections that weigh about 40 pounds each and is easily carried on two backboards. A 5-gallon can that completes the necessary equipment may be carried on a third packboard.

The immersion-type heater is designed for use with corrugated cans and tank trailers. It is used primarily to heat water for washing and sanitizing dinnerware and cooking utensils in the field. It is designed to heat water in either 24- or 30-gallon corrugated cans.

In cold climates, the heater can be used for melting snow or ice into water. It also can keep existing water supplies from freezing. In extreme emergencies, the heater may be used to heat a tent or other shelter, provided the exhaust fumes are piped out of the enclosed space.

Gasoline is the prescribed fuel. Although kerosene, diesel oils, and fuel oils may be burned in the heater, they produce more smoke and require a longer preheating period. A full tank of gasoline (2.2 gallons) should run the heater for 6 hours under normal operating conditions. However, if operated continuously at a high-fire rate, a tank of gasoline may be consumed in less than 4 hours.

The tank trailer water heater is designed for use in cold climates to keep water supplies from

freezing. It is used to heat water in 250- and 400-gallon water tank trailers and in a 700-gallon water tank truck. With the same provisions as the immersion-type heater, it also can be used in emergencies to heat a tent or other personnel shelter. Fuel requirements and capabilities of the heater are same as those of the corrugated can heater.

The Army TM, *Basic Doctrine for Army Field Feeding*, FM 10-23, contains the minimum information necessary to safely operate the immersion-type heater. Be sure you receive a copy of the TM with the immersion heater.

IMPROVISED STOVES

Any large metal container, such as a washtub, can be easily made into a stove. It is only necessary to provide an opening for tending to the fire and the bottom draft and to make a chimney at the top. A tin can with both ends removed makes a good chimney.

You can make a surprisingly efficient gasoline stove by using two cans. Pierce the outer empty can, preferably a No. 10 can, with nail holes. This is done from the top sides down to within about 1 1/2 inches from the bottom. Next, put clean sand into the can filling it up to the level where the holes begin. Then saturate the sand with gasoline. There should be no liquid gasoline visible on top of the can.

Use any can of smaller size for the inner can. Puncture it on the sides and bottom with holes. Then, place it in the center of the larger can, bottom up. The nail holes furnish a draft and upward direction of heat.

If no better way is available, you can set up a makeshift cooking arrangement. This is done by suspending a long green pole, preferably one that has not dried out, between two upright supports. Suspend the kettle of food directly over a flame or push it to the side to keep warm.

UNLOADING KITCHEN EQUIPMENT

You must first unload the field kitchen equipment from the vehicles that delivered it to the field before you can use it. This equipment is heavy. You should not try to unload an M59 field range outfit by yourself; always seek help.

When there is enough personnel to unload the equipment, ease the equipment off the truck and to the ground. Follow all safety rules while unloading the equipment to prevent damage to the equipment or injury to personnel.

After unloading the equipment, you will unpack it before placing it inside the field kitchen. You will need a hammer and a crowbar for this task. The crates are made of plywood and nailed shut for storage or transport. In some Marine Corps units, hinges, hasps, and locks are used to make the task easier. In such instances, be sure to remember the keys.

Exercise extreme care when opening the crates and removing the equipment to prevent damage to the crates or equipment. The crates will be used again later to repack the equipment when field mess operations are ended.

KITCHEN EQUIPMENT ARRANGEMENT

Before placing equipment inside the field kitchen tent, you should first find out what type and quantity of equipment are needed to accomplish the mission. The following are some of the factors that determine the quantity and type of equipment and its location:

- Number of personnel subsisting
- Number of days of operation
- Weather

The field mess equipment to number of personnel ratio is as follows:

- One M59 field range outfit for each group of 50 persons
- One accessory outfit for every two M59 field ranges
- One insulated food container and one vacuum jug for every 25 persons

When planning the layout of the equipment, you should draw a diagram (fig. 11-11) to show where each piece of equipment will be placed. Drawing a diagram will give you a good look at where to place each piece of equipment in relation to the space available. This also will save you time and prevent having to move the equipment around, once it is placed. Last, the diagram will help in determining the appropriate placement to best support the working conditions.

Each of the nine areas shown in figure 11-11 will be discussed in the following paragraphs.

M59 Field Range

The placement of the field ranges (area 1) will change with the season of the year.

In the summer months, the field ranges should be placed in the center of the tent (as shown in fig. 11-11). This allows the heat from the ranges to rise and filter out the air vents and the ends of the tent. In cold weather, the field ranges should be placed along the side walls of the tent. This allows the heat to reflect from the top of the tent and return to the work area.

Fire Extinguishers

Place the fire extinguishers (area 2) close to the field ranges in case of a fire. One fire extinguisher is required for every two ranges. Instruct all personnel on proper use of the fire extinguishers.

Worktables

Locate the cooks' worktables (area 3) close to the ranges to permit accessibility to the ranges. Place these tables so they do not interfere with the normal replenishing of the serving line. The cooks' worktables can be the folding type or the packing crates for the field ranges can be used for this purpose.

Ingredients Rack

Place the ingredient rack (area 4) where it will not interfere with the normal flow of traffic during the cooks' meal preparation.

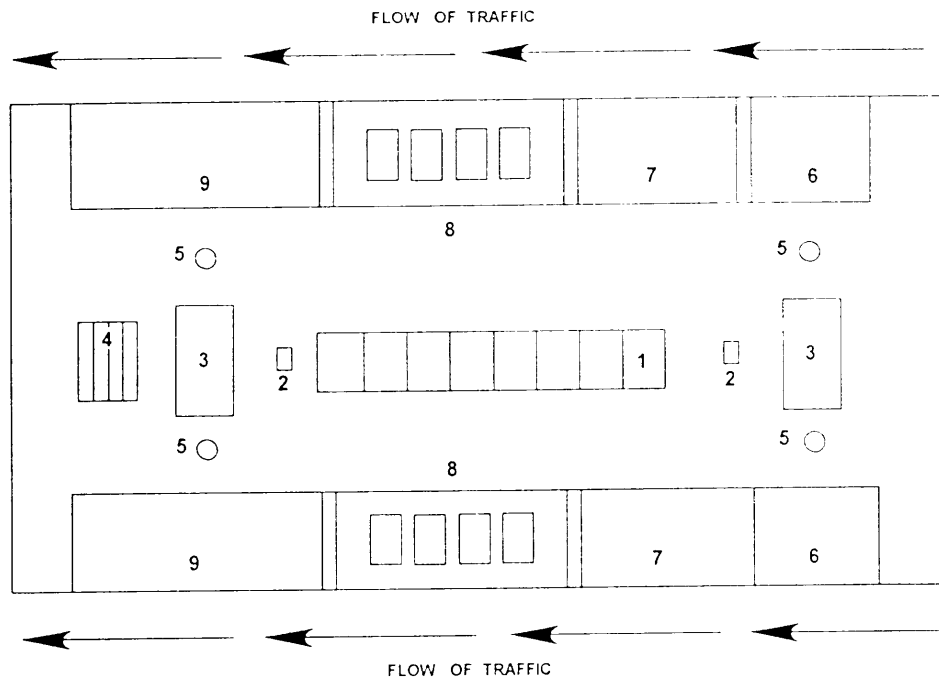

- | | |
|------------------------------|----------------------------|
| 1. M-59 FIELD RANGES - 8 | 6. SALAD BAR |
| 2. FIRE EXTINGUISHERS | 7. IMPROVISED GRILL |
| 3. WORKTABLES | 8. IMPROVISED SERVING LINE |
| 4. INGREDIENTS RACK | 9. CONDIMENT RACK |
| 5. CANS—32 GAL—TRASH GARBAGE | |

Figure 11-11. Diagram showing positioning of equipment used to feed 550 personnel.

Trash Cans

Locate the trash or garbage cans (area 5) where they will be easily accessible for both food preparation and cooking.

Salad Bar

The salad bar (area 6) should be at the head of the serving line. This will allow the troops to make their selection of the cold foods first. This also will prevent a bottleneck in the serving line.

Improvised Grill

The improvised grill would be the next piece of equipment in line (area 7). This will permit all griddle-fried foods to be prepared and served to the troops as they move through the line.

Improvised Serving Line

The serving line should be located next (area 8). All hot foods not served from the improvised grill are served from the serving line.

Condiment Table

The condiment table (area 9) should be the last in line. This permits the troops to select the condiments they wish without interfering with the normal flow of traffic.

Finally, check the placement of the equipment with your diagram. Keep in mind that the diagram should reflect the actual location of the equipment. At this point, each piece of equipment should be placed where it may be used most practically.

FIELD SANITATION

Due to limited facilities in a combat area, the use of proper sanitation measures cannot be overemphasized. Every precaution should be taken to prevent food from becoming infected and utensils from becoming contaminated. Rigorously enforce all personal hygiene measures.

Place a corrugated can of boiling water at the head of the serving line so dinnerware and trays can be predipped. Predipping will partially sterilize utensils and, in cold weather, will give them a desirable warmth.

When using emergency cooking facilities or equipment, do not use galvanized containers for storage of liquids or for cooking any foods and beverages. This is particularly so for acid foods. Pails and garbage cans are examples of galvanized containers. These containers are coated with zinc that dissolves on contact with food acids. Poisoning from this source can result in serious and sometimes fatal illness. Only use these containers to store foods such as flour, sugar, beans, and other bulk dry items.

Field Dishwashing

The field dishwashing unit (fig. 11-12) consists of five corrugated cans placed in line to form a battery. As many such batteries may be used as needed to handle the flow of traffic during the meal period. The recommended battery is made up as follows:

First can:	Garbage waste
Second can:	Contains prewash warm water, detergent, and a long-handled scrub brush attached. Change the prewash water as frequently as necessary to avoid carry-over of grease and food particles into the rest of the system.
Third can:	Contains hot water (120°F to 140°F) with an adequate amount of detergent so washing is accomplished quickly and adequately. This can should have a long-handled scrub brush attached.
Fourth can:	Contains actively boiling water for first rinse.
Fifth can:	Contains actively boiling water for second rinse.

One battery will accommodate 80 people.

After washing the utensils thoroughly in the wash cans, immerse them for a total of 30 seconds in the two rinse cans. When the rinse water is actively boiling, this procedure will achieve sanitation. Hot water is the preferred method of sanitation, but chemicals may be used.

After the battery has been secured, scrub the cans thoroughly, flush them, and invert them to allow complete draining and drying. Mark each can for its designated use. This will aid in restricting use of each can to the purpose that it is intended.

For complete information on field dishwashing and sanitation, refer to the *Manual of Naval Preventive*

Medicine, NAVMED P-5010, chapter 9, and the *Standard Organization and Regulations of the U.S. Navy*, OPNAVINST 3120.32. The contents of these publications will aid you in combating health hazards that are ever-present in these areas.

Cleaning Field Kitchen Equipment

Field messes range from primitive cooking accomplished in a tent to semipermanent structures with piped-in water, concrete decks, and portable galley equipment. Some of these field messes may have stainless steel surfaces for food preparation, although only wooden surfaces may be available in others. Regardless of the type of structure, cleanliness will be the key to the prevention of foodborne illness outbreaks. The following information provides general cleaning guidance and should be used together with chapter 1 of the NAVMED P-5010:

- Thoroughly clean and sanitize all preparation and serving equipment after each meal period.
- Make all needed repairs to equipment as soon as practical.
- Clean and sanitize all food contact surfaces as described in chapter 1 of the NAVMED P-5010.
- Install all foodservice equipment off the ground and protected from contamination by dust and vermin.
- Cover wooden surfaces with clean, heavy wrapping paper or waxed paper. Discard the paper after each meal period. If paper is not available, wipe down the surfaces, scrub with an approved sanitizing solution, and air-dry after each meal period.
- Encourage the use of disposable eating utensils. The benefits of reduced disease risk and water and fuel savings outweigh the solid waste disposal disadvantage.
- Pesticides should only be applied by certified personnel.

The job of servicing and cleaning of the field range cabinet is simple but important. Keep the cabinet as mechanically efficient as the burner unit for peak performance. Your first step in servicing the cabinet should always be to inspect for defects. Check the structure of the cabinet to make sure it is free of holes, dents, and broken welds. Check the rails to make sure they are straight, undented, and firmly welded into the cabinet.

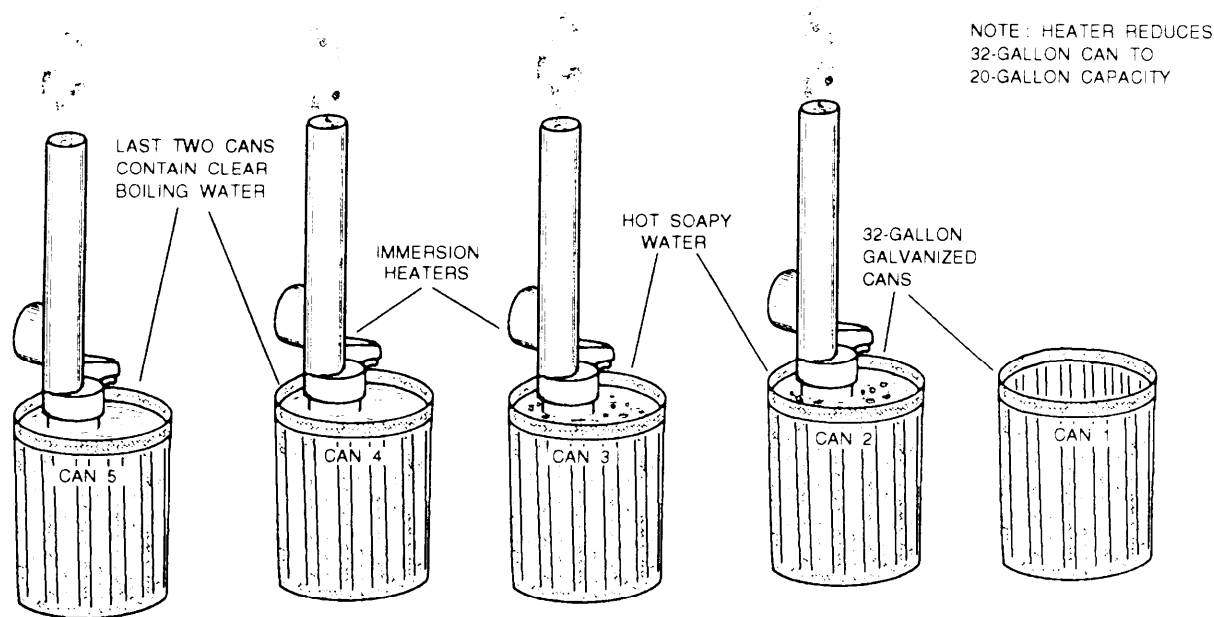

Figure 11-12.-Five-can dishwashing battery.

Lubricate all moving parts with light lubricating oil to ensure proper functioning. Examples of moving parts are hinges, handles, and rollers. You should lubricate the rails within the cabinet (used for positioning the burner unit) with an antiseize compound. This makes it easy to slide the cradle with the cooking pot and the burner unit in and out of the cabinet.

You should clean the field range cabinet after each meal. This is done by scrubbing with hot soapy water and a stiff scrub brush to prevent buildup of drippings and food particles. You also should clean the cabinet as you go. Spilled liquids on the cabinet should be wiped off immediately. Do not allow food particles and liquids to bake onto the cabinet.

Do not use abrasives such as a wire brush, steel wool, or emery cloth on the sheet metal or aluminum alloy. To do this would mar the finish. Rinse the cabinet thoroughly with hot clear water and dry.

Pest Control

Sanitary precautions include measures to eliminate pests and prevent their breeding. The two most important types of pests for you to control are flies and rodents.

FLIES.— In areas where flies are present in large numbers, special care must be taken. The housefly breeds in excrement of human beings and animals as

well as decomposing vegetable and animal matter. Disease organisms are carried on the feet of the fly to food and utensils. The fly takes only liquid foods and regurgitates to dissolve solids. This process causes further contamination.

Extreme care should be taken to prevent access of flies to food utensils, kitchens, and feeding areas. In a permanent camp, all areas that attract flies should be well screened. It should be standard operating procedure that the galley be screened before hot food is prepared init. Screens should have a mesh of 18 wires to the inch (18 mesh), which also keeps out mosquitos. In a semipermanent camp, screening may be impractical; so, dependence must be placed upon cleanliness and insectproof containers.

When there is no metal screening available, mosquito netting, target cloth, or similar material may be used to flyproof tents, galleys, and storage areas. Leaking screens (especially cracks around the screen door) frequently convert a building into a flytrap; that is, flies can enter the building but are unable to exit. Screen doors should be made to open outward and should be in direct sunlight, when practical. Fly breeding in human excreta is particularly dangerous; thus, whenever possible, latrines should be carefully flyproofed.

The substances that may be used to kill the adult fly are often extremely poisonous. Thus, the use of these

substances is the responsibility of the medical officer, as is the use of measures to prevent breeding of flies. However, it is up to you to keep flies off the food in the galley and feeding areas. When flies are present, food servers should keep covers on serving containers except when they are actually placing food on trays.

Use traps or flyswatters freely. Sticky flypaper can be made by heating castor oil (five parts by weight) and powdered resin (eight parts) until the resin is dissolved. Do not boil this solution. Apply it to glazed paper while it is still hot or paint it on iron hoops or wire strands. Wires so painted should be cleaned and recoated every 2 or 3 days.

RODENTS.— The rodent is an ever-present menace to operations in the field. Rodents such as rats, mice, and ground squirrels are reservoirs for plague, endemic typhus, tularemia, and many other debilitating diseases. When operations become more stable and semipermanent or permanent camps are established, the additional hazard of the destruction of material must be considered. The distribution of rodents may be considered universal. Therefore, the problem of their control is encountered during operation in any geographical location.

Rodent control is the responsibility of the medical officer, but the proper handling of food and the prompt disposal of trash and garbage are essential and lie within your domain. Food supplies should be stored on elevated platforms. If possible, all food stores should be packaged in ratproof containers. When buildings are used, all doors should be self-closing and tight-fitting. All other openings in excess of 1/2 inch should be closed with material resistant to gnawing rodents or screened with 1/2-inch mesh hardware cloth. Chapter 6 of the NAVMED P-5010 has additional information on the destruction of rodents.

LOADING KITCHEN EQUIPMENT

Make sure there is a loading plan for the equipment.

Prepare the equipment for transport by disconnecting it as outlined in the appropriate manuals. Be sure to drain water and fuel from water pumps, water heaters, and fuel tanks.

You should inspect and inventory the equipment before loading it to make sure all parts are present and undamaged. You can then pack the equipment into the original crates.

If you are moving to a new site, items that will be needed last should be loaded first. This equipment is heavy. Follow all safety rules while loading the equipment. Improper handling can result in damage or loss of equipment and personnel.

Distribution of the equipment in the truck is important. Improper distribution (underloading and overloading) can cause damage to the equipment and the vehicle. Load all heavy items on the bottom. Load equipment only as high as the truck will allow.

Finally, make one last check to make sure all equipment is properly secured against movement and protected from weather.

Following the correct procedures for closing the field kitchen area of operations is extremely important. You must consider the environmental impacts caused by soakage pits, grease traps, trash pits, and incinerators. Also, you must understand the battlefield signature that a haphazardly closed field kitchen site can leave for enemy forces. FM 5-20, *Camouflage*, and FM 21-10, *Field Sanitation and Hygiene* (Army field manuals), provide information to help you properly close your field kitchen site.

FOODSERVICE ADMINISTRATION

As a Mess Management Specialist (MS) first class or chief, you are at the midmanagement level in your career. In this position of authority, you will have direct working relationships with the supply officer, food service officer (FSO), other supervisors, and subordinates. Your success will be largely determined by your ability to develop strong working relationships with these people. As you should support the workers in your group, so should you turn to your supply officer, FSO, and other supervisors in your division for their support in making your job more effective. You will earn the support of these personnel through cooperation and willingness to assist others, through earnest efforts to do your job well, and through constant efforts to improve yourself, your organization, and the ship or station to which you are attached.

This chapter discusses the use of your administrative skills in procuring food items, using foodservice cost control procedures, and maintaining accountability.

PROCUREMENT OF FOOD ITEMS

Although the supply officer or FSO is responsible for procuring of food items, in some instances you must perform these duties. In either case, your experience, your knowledge, and your planned menus will be extremely valuable when preparing requisitions.

A thorough knowledge of the mechanics of procurement is essential. Each phase will be discussed and explained in this chapter. However, before any thought is given to the actual preparation of requisitions and purchase orders, you should determine your needs. This cannot be done on the spur of the moment. You should know what stocks are on hand, how much can be loaded in each storage space, and when to order.

Whatever you procure must be receipted for, inspected, and stored. Chapter 2 covered the points to help you accomplish this efficiently and safely. Prior planning and preparation will eliminate confusion, disorganized storage spaces, and the resultant survey of spoiled food items.

This portion of the chapter is intended to help you find the answers to such questions as the following:

- What items should I consider to develop a balanced load?
- How do I establish the stockage objective and determine the provision requirements for my ship or station?
- What catalog should I use when purchasing or requisitioning food items?
- When requisitioning from other Navy activities, what paper work do I submit?
- What should I do with unsatisfactory food items?
- What are my duties in connection with underway replenishment?
- Where in the freeze box should pork, veal, lamb, poultry, and fish be stored?

The fleet cannot stay at sea without food. You are responsible for ensuring maximum endurance capability of your ship.

During the past few years, several crises have arisen that required ships to report to their stations on extremely short notice. There may be other crucial periods in the future that will require similar action.

BALANCED LOAD

You should aid the FSO in developing a balanced load. Use the menu as a daily tool for maintaining a balanced load. A well-developed cycle menu, in conjunction with a frequency chart of major menu items, will aid in determining balanced load requirements. When deployed, you will want to keep a close check on inventories to make the best use of your remaining stocks.

You should have the following information when you are developing a balanced load:

- The fleet commander's operation plan that established endurance by ship type for each category of stores
- The amount of cubical storage space available for normal operating conditions and the amount of deck storage space available in the event of emergency operations

- Your ship's operating schedule

Remember, you cannot establish your food item endurance loads on the basis of formulas and graphs alone. You should apply common sense and good judgment to the problem.

If you have usage data that were generated during extended unreplenished operations, you have ideal information to use in planning your endurance load. However, if the only available data represent usage during replenishment operations or when normal liberty was granted, the data would not reflect requirements for true endurance conditions. Such data can, however, be a help in deciding what foods to include in your endurance load list. When local usage data are applicable, and usage data from a ship of the same class are not available for use in planning load lists, refer to the subsistence endurance base (SEB) in the NAVSUP P-486. This guide is also a helpful tool for MSS who have had limited experience in planning load lists. The *Navy Food Service*, NAVSUP P-476 (a quarterly foodservice publication), also includes articles on endurance loading.

STOCKAGE OBJECTIVES

The stockage objective for food items should be the total of the operating level plus the safety level in terms

of days of supply (fig. 12-1). The operating level of supply is the amount of material required to sustain operating requirements between replenishment periods. The safety level of supply is generally the quantity required to be on hand, in addition to the operating level, to permit continued operations if a minor interruption of normal replenishment or unpredictable fluctuations in demand occur. Stockage objectives for ships are issued by the appropriate type commander. Stockage objectives for food items for activities in Alaska, Hawaii, and overseas are issued by the fleet commanders through their logistics agents.

Continental United States (CONUS) activities maintaining inventories of food items in end-use accounts, who requisition and stock food items under the appropriation Operation and Maintenance, Navy (O&MN) Subsistence Account, as authorized by the Navy Food Service Systems Office (NAVFSSO), should use the stockage levels recommended in the NAVSUP P-486, volume I.

A low limit and a high limit should be established for each item of stock at the beginning of each accounting period. Low limits and high limits should be adjusted as necessary for the following reasons:

- Increase or decrease in crew size

<i>Operating level</i>	the quantity of material needed to sustain operations between replenishment	
+ (plus)		
<i>Safety level</i>	the quantity needed for continuous operations in the event normal replenishment is interrupted or to meet unpredictable fluctuations in demand	
= (equals)		
<i>Stockage objective</i>	the maximum quantity of material to be maintained on hand to sustain current operations	<i>Average endurance level</i> is the quantity of material normally required to be on hand to sustain operations for a stated period without augmentation; it is also the safety level plus one-half of the operating level.
+		
<i>Order and shipping time</i>	represents the quantity of material that will be consumed during the interval between submission of requisition and receipt of material (procurement lead time)	<i>Low limit</i> (reorder point) is the stock position which signals the need to initiate replenishment action. It includes the sum of stocks represented by the safety level and the order and shipping time.
=		
<i>Requisitioning objective</i>	the maximum quantity of material to be maintained on hand and on order to meet current operational requirements	<i>High limit</i> includes the sum of stocks represented by the operating level, the safety level, and the order and shipping time.

Figure 12-1. Stockage objective for food items.

- Expected operations
- Change in crew preference
- Changes in the menu
- Any other factors affecting the consumption of the items being ordered

Low Limit

The low limit is the stock position that signals the need to begin replenishment action. There will be no low limit for perishable subsistence items except when that item has a storage life greater than the high limit number of days' endurance established by the fleet or type commander.

To compute the low limit for subsistence items, use the following formula:

$$\frac{\text{Total quantity consumed during the previous accounting period (less surveys and transfers)}}{\text{divided by}} \\ \frac{90 \text{ (days in an accounting period)}}{\text{times}} \\ \text{number of days' endurance for the low limit as established by the fleet or type commander equals low limit.}$$

High Limit

The high limit is the maximum quantity of subsistence to be maintained on hand to sustain current operations. The high limit for perishable subsistence items will not exceed the storage life of that item times the total quantity from the previous accounting period less surveys and transfers divided by 90.

To compute the high limit for subsistence items, use the following formula:

$$\frac{\text{Total quantity consumed during the previous accounting period (less surveys and transfers)}}{\text{divided by}} \\ \frac{90 \text{ (days in an accounting period)}}{\text{times}} \\ \text{number of days' endurance for the high limit as established by the fleet or type commander equals high limit.}$$

EXTENDED ENDURANCES

The meal summaries in appendix F of the NAVSUP P-486, volume I, show how many times each menu item can be served, using the 45-day endurance base stocks

listed. Consider these meal summaries and local acceptance when adapting the 45-day SEB onboard storage capabilities and as a basis for planning a readiness menu for implementation during extended operations or when replenishment are delayed.

DETERMINING PROVISIONS REQUIREMENTS

You are always required to have enough food items on board to provide for a specific period. This means enough food to provide a balanced diet. Your fleet commander specifies this period, in days, and this period varies among fleets and among type commanders. You are responsible for carrying out the directives you receive on maintaining specific quantities of food items.

Requirements

Fast frigates are expected to carry a 45-day stock. You should be ready to get underway whenever required and not worry about replenishing for at least 45 days. You should have enough of the right kinds of foods aboard to provide a balanced diet during deployment. Normally, fleet commanders specify that ships should replenish every 2 weeks while they are in the United States. The fleet commander also may specify that all ships top off storerooms (fill the storerooms to capacity). This will enable ships to stay at sea for a maximum period without replenishment.

These requirements may not be valid on your ship. When you report on board a ship for duty, check the fleet commander's instructions for the actual requirements in your area.

Five steps should be considered when you are determining your requirements. These steps are proper for either general or private messes.

Step one of your loading out is determining your present stock level; this can be done by checking your Stock Tally, NAVSUP Form 209, and your Subsistence Ledger, NAVSUP Form 335, for quantities on hand.

In step two you determine the capacity of the total storage area and then divide that figure into dry, chill, and freeze storage areas. Figuring space availability will be discussed later in this chapter.

Step three should be the planning of your menus. Menu planning is discussed in detail in chapter 7, but to keep this section on procurement in a logical order, a brief mention of menus will be made now.

When you are planning menus for extended, un replenished periods, the use of specialty items such as pizza crusts, potato chips, or ice-cream cups should be ordered in quantities that will not tax your storage spaces. The use of cycle menus is extremely important in preparing for deployment. Cycle menus are always an excellent management tool, but especially valuable when you are preparing for an extended deployment.

For more information on cycle menus, refer to the menu planning section of the *Foodservice Operations Manual*, NAVSUP P-421. If you have cycle menus already prepared, review them closely. Make changes and substitutions where necessary to use more stable food items such as dehydrated peppers instead of fresh peppers and dehydrated potatoes instead of fresh potatoes. Custom foods should be used to their fullest extent when you are planning for deployment. Fresh produce has a higher acceptability; therefore, you should stock what you can, considering the spoilage factor and the storage capacity.

When you are considering requirements for a deployment, think storage capacity and custom finds. The term *custom food* is used to describe the various types of laborsaving and spacesaving processed foods that are authorized for Navy messes. The basic forms of custom foods are canned, dehydrated (including dehydrated compressed), and frozen. Custom foods are economical spacesavers and, if properly used, will reduce the operating cost of the mess.

In step four you should determine the quantities of food items that are necessary for a specific period, such as the time between replenishment and your next scheduled replenishment.

The word *scheduled* is emphasized because you should allow for unforeseen circumstances when your scheduled replenishment date cannot be met. For example, inclement weather could cause the postponement of replenishment, supply ships may not be available, or the supply center maybe out of an item or items.

In step five you should be able to identify the available supply source(s). You may be required to help the supply officer, FSO, or mess caterer requisition and procure food items; in some instances, you must perform these duties on independent duty. In either case, your experience, your knowledge, and your planned menus will be extremely valuable to you when you are preparing requisitions.

Procurement Publications

Certain publications are required when you requisition or purchase food items. The *Federal Supply Catalog* (FSC), *Group 89, Subsistence*, is used to requisition food items. Refer to contract bulletins when you purchase food items under contract. Defense Logistics Agency (DLA) contract bulletins also may list resale food items. These items are not authorized for GM use.

The FSC furnishes the identification and management data for items required by the Army, Air Force, Marine Corps, and Navy. It provides the official source of identification for Department of Defense (DOD) supply and procurement activities. The stock list (fig. 12-2) is published annually and updated by the publication of cumulative change bulletins.

Group 89 (except class 8965) contains items for which activities in the DOD have recorded requirements. Part I, Alphabetical List, is a list of all food items arranged in alphabetical sequence by subgroups within each of the following classes:

8905	Meat, Poultry, and Fish
8910	Dairy Foods and Eggs
8915	Fruits and Vegetables
8920	Bakery and Cereal Products
8925	Sugar, Confectionery, and Nuts
8930	Jams, Jellies, and Preserves
8935	Soups and Bouillon
8940	Special Dietary Foods and Food Specialty Preparations
8945	Food Oils and Fats
8950	Condiments and Related Products
8955	Coffee, Tea, and Cocoa
8960	Beverages, Nonalcoholic
8970	Composite Food Packages

Part I contains a list of all food items arranged in alphabetical sequence by subgroups within each FSC class. It also contains descriptive and related management data.

Part II, Ration Components, contains those ration components that are authorized for requisitioning by military services.

ACTION CODE	INDEX NUMBER	NATIONAL STOCK NUMBER	PERISHABILITY	DESCRIPTION	UNIT OF ISSUE	CONVERSION FACTOR	USAGE MANAGEMENT CODE	REQUISITION CODE
		8905		<u>PORK</u>				
	1900	00-419-4320	P	BACON, CANADIAN STYLE (MADE IN USA), frozen, unsliced, cured, smoked, 5 to 9 lb, USDA IMPS, Item No. 550, selection 1 and/or 2	LB	1.000	-	H
	1910	00-551-9908	P	BACON, SLAB, chilled, cured, smoked, 8 to 14 lb, USDA Specification For Slab Or Sliced Bacon, Schedule SB	LB	1.000	a	H
	1920	00-551-9910	P	BACON, SLAB, frozen, cured, smoked, 8 to 14 lb, USDA Specification For Slab Or Sliced Bacon, Schedule SB	LB	1.000	-	H
D		00-782-6413						
C	1930	01-034-7550	P	BACON, SLICED, frozen, cured, smoked, 8 to 10 in. lg slices, 18 to 22 slices per lb, 1 lb shingled vacuum pg, USDA Specification For Sliced Bacon, Schedule SL, style 2, (ADCoP)	LB	1.000	-	D
C	1950	00-403-9592	P	BACON, SLICED, (BULK) frozen, cured, smoked, 8 to 10 in. lg slices, 18 to 22 slices per lb, 1 lb shingled vacuum pg, USDA Specification For Sliced Bacon, Schedule SL, style 2, (ADCoP)	LB	1.000	-	H
				acceptability (ADCoP)				
C	2010	00-209-5923	P	CHITTERLINGS, RAW, frozen, high commercial grade, w/demonstrated commercial market acceptability (ADCoP)	LB	1.000	-	H
	2020	00-753-6426	P	FRESH HAM, BONELESS (ROAST), frozen, uncured, skinned, shankless, enclosed in stretchable netting, 8 to 12 lb, USDA IMPS, Item No. 402C, selection 2 or better, wt range B and/or C	LB	1.000	-	H
C	2030	00-782-3329	P	HAM, CANNED, pullman or pear shaped, boned, w/natural juices, 3 to 5 lb, high commercial grade, w/demonstrated commercial market acceptability (ADCoP)	LB	1.000	g, h	L
	2040	00-023-8284	NP	HAM CHUNKS WITH JUICES, CANNED, smoked, vacuumized and heat processed, 29 oz net wt, 401 by 411 size can, IP/DES S-1-0 (ITEM NAME FORMERLY: HAM, CANNED)	CN	1.813	b, d	D
	2050	00-126-3393	P	HAM, CANNED (PEAR), whole, boneless, cured, skinless, shankless, w/ or w/o liquid smoke, vacuumized and heat processed, 11 or 12 lb, USDA Specification For Canned Ham, Schedule CH	LB	1.000	-	H
	2060	00-410-4670	P	HAM, CANNED (PULLMAN), whole, boneless, cured, skinless, shankless, w/ or w/o liquid smoke, vacuumized and heat processed, 11 or 12 lb, USDA Specification for Canned Ham, Schedule CH	LB	1.000	-	H

Figure 12-2. Federal Supply Catalog stock list.

Part III, Case Lot Data (fig. 12-3), is arranged in numerical sequence by national stock number (NSN). It provides weight and dimensional data applicable to unit package for items in part I for which these data are available.

Fleet Instructions

Fleet commanders furnish instructions for establishing and maintaining a balanced load through the *Atlantic Fleet Requisitioning Guide*, CINLANTFLTINST 4210.1, and the *Pacific Requisitioning Guide*, CINPACFLTINST 4235.1.

Afloat requisitioners, both Atlantic Fleet and Pacific Fleet, use the single *Consolidated Afloat Requisitioning Guide Overseas (CARGO)*, NAVSUP P-4998, chapter 3, titled "Subsistence Requisitioning Tables." These tables contain information on stock management of food items and requisitioning procedures. The available seasonal fresh produce listing differs for the Atlantic and the Pacific Fleets. By direction of the Naval Supply Systems Command, the CARGO is issued annually by the Fleet Material Support Office (FMSO).

The Subsistence Requisitioning Tables listed in the CARGO show quantities of food items for nine

ACTION	NSN	INDEX NUMBER	PACKAGE UNIT	PACKING DATA							
				NO OF UNITS PER CASE	NO OF CASES PER PALLET	CASE GROSS WEIGHT (LBS)	CASE NET WEIGHT (LBS)	CASE CUBIC FEET	CASE DIMENSIONS (INCHES)		
									LENGTH	WIDTH OR DIAMETER	HEIGHT
B	8905-00-138-7161	2490	LB	54		60	54	1.85	23.0	17.0	6.2
	8905-00-138-7167	2560	CN	24	40	38	34	1.15	16.6	12.6	5.6
	8905-00-138-7180		LB	45		47	45	1.20	20.0	16.0	6.5
	8905-00-139-8481	3020	CN	24	72	27	18	1.85	12.5	9.5	9.5
	8905-00-143-0969	770				65	60	1.85	22.0	17.5	6.5
	8905-00-143-3294	2590	BX	4							
	8905-00-143-4667	1270	BC	10		32	30	1.40	15.5	13.0	12.0
	8905-00-149-0768	20010									
	8905-00-149-1065	20100									
	8905-00-149-1067	20000									
D	8905-00-149-1068	20030									
	8905-00-149-1069	20040									
	8905-00-149-1070	20060									
	8905-00-149-1071	20080									
	8905-00-149-1355	2200	LB	30		32	30	1.78	17.0	11.5	6.0
	8905-00-164-0463	1110	LB	50		34	30	1.22	15.0	10.0	14.0
	8905-00-164-0467	1230	LB	50		35	30	1.06	17.0	18.0	18.0
	8905-00-164-0469										
	8905-00-164-0485	1000	LB	50		34	30	1.22	15.0	10.0	14.0
	8905-00-164-0488	1220	LB	24		28	24	1.68	21.0	12.0	11.5
D	8905-00-164-0490	980	LB	50		34	30	1.22	15.0	10.0	14.0
	8905-00-164-6874	1290	LB	50		60	50	1.44	12.0	13.0	16.0
	8905-00-170-8246	20070	CN	96	36	43	33	1.08	18.2	12.2	8.4
	8905-00-170-9598										
	8905-00-177-5017	600	BC	1		54	50	1.87	20.0	15.0	5.0
	8905-00-543-7333	2700	LB	115		125	115	3.75	32.0	22.5	9.0
	8905-00-543-7941	910	CN	24		29	26	1.67	18.3	12.1	5.0
	8905-00-551-9908	1910	LB	70		75	70	1.78	25.7	12.0	10.0
	8905-00-551-9910	1920	LB	70		75	70	1.78	25.7	12.0	10.0
	8905-00-577-5493	1560	BX	6		65	60	1.67	10.0	12.0	24.0
D	8905-00-582-1323	530	LB	50		54	50	1.87	20.0	15.0	5.0
	8905-00-582-1330	1970	CN	24	42	41	35	1.05	14.2	10.7	11.9
	8905-00-582-1339	1520	LB	70		75	70	1.78	25.7	12.0	10.0
	8905-00-582-1340	2460	BX	4		65	60	1.85	22.0	17.5	8.3
	8905-00-582-1341	2750	LB	115		125	115	3.75	32.0	22.5	9.0
	8905-00-582-1343	920	CN	48	48	42	38	1.83	17.0	13.7	6.2
	8905-00-582-1345	2170	LB	50		54	50	1.91	30.0	11.0	10.0
	8905-00-582-1346	1530	LB	60		65	60	1.25	20.0	12.0	9.0
	8905-00-582-1393	2570	BX	4		65	60	1.85	22.0	17.5	8.3
	8905-00-582-1394	2620	BX	4		65	60	1.85	22.0	17.5	8.3
D	8905-00-582-1398	1650	LB	60		65	60	1.67	10.0	12.0	24.0
	8905-00-582-1399	1640	LB	70		75	70	1.78	25.7	12.0	10.0
	8905-00-582-4035	2640	LB	25		27	25	1.82	21.5	15.3	4.3
	8905-00-582-4038	1310	CN	24	36	37	29	1.23	16.0	10.8	12.3
	8905-00-582-4039	1340	LB	50		58	50	2.43	13.0	17.0	19.0
	8905-00-582-4042	2760	LB	60		68	60	1.58	31.0	16.0	5.5
	8905-00-582-4049	430	LB	65		69	65	2.75	22.8	18.0	9.5
	8905-00-582-4051	2480	LB	54		60	54	1.86	23.0	17.0	8.2
	8905-00-584-3212	1260	BC	6		52	51	1.86	13.2	11.1	10.2
	8905-00-616-0048										
8905-00-616-0050	1590	LB	60		65	60	1.67	10.0	12.0	24.0	
8905-00-641-8941	950	CN	24		24	19	1.60	16.3	12.2	5.2	

Figure 12-3.-Federal Supply Catalog, part III, case lot data.

alternative balanced loads identified by column headings A through I. Column headings also provide approximate numbers of persons supported by each column. Support ranges from a 30-day level for approximately 83 persons (column A) to a 30-day level for 3,000 persons (column I).

When using the CARGO, determine your requirements for all items listed in the applicable tables by doing the following:

- Checking your storerooms to see what stores you have and what space you have

- Checking your records to see what you have used
- Being sure you are ordering enough food items to include the private messes aboard

StorageData

If your GM requirements for each food item, including perishables, were based on subsisting 1,000 personnel for 30 days, you should adjust the cube and weight data to reflect local delivery schedules for various foods before listing the data to estimate storage requirements. For example, the chill storage

requirement for milk for 1,000 personnel for 30 days is 1,063 cubic feet; however, this is based on milk being delivered daily except on Sunday. For example, the storage requirement for a 20-day supply of milk is 20/30ths of 1,063, or 709 cubic feet. Adjust storage data when requisitioning frozen meats instead of chilled sausage meats and other cured meats. Chilled storage is recommended for fresh potatoes and onions. If you have separate specific storage areas for these items, adjust the chill storage requirements accordingly. Storage requirements reflect only the space required for the foods in their packaging. You should estimate the additional space required for air circulation, aisles, shelves, and battens. The many variations in storage space configuration make a standard modification impractical.

The 45-day SEB and the 6-month requirement for spices and low-use staple items for afloat GMs are contained in NAVSUP P-486, volume I, appendixes D and E, respectively. They serve as guides in planning readiness requirements for those ships with prescribed endurance that extend beyond 30 days. The SEB includes a larger portion of dehydrated and other spacesaving items and a smaller portion of refrigerated items than is generally used when operating conditions permit regularly scheduled replenishment of more bulky perishable items. When these endurance base guides are used in combination with 30-to 45-day stock levels that reflect an individual ship's normal usage, endurance levels can be adapted to the storage space limitation of the ship.

Procurement Restrictions

Food items authorized for Navy use are listed in the FSC. Requests for exceptions or deviations from usage restrictions should be submitted via the chain of command to NAVFSSO with complete justification. Brand name items are not authorized. Check the NAVSUP P-486, volume I, for further information about procurement restrictions.

Private messes have the option to use either the Navy supply system or commercial vendors, or both.

Determining Space Availability

Now that you know how to estimate quantities, you should learn to estimate storage space. You do not want to order more than can be stored.

The capacity of a compartment shaped like the one shown in figure 12-4 is found by multiplying the length by the width by the height; for example, 20 x 15 x 10= 3,000 cubic feet.

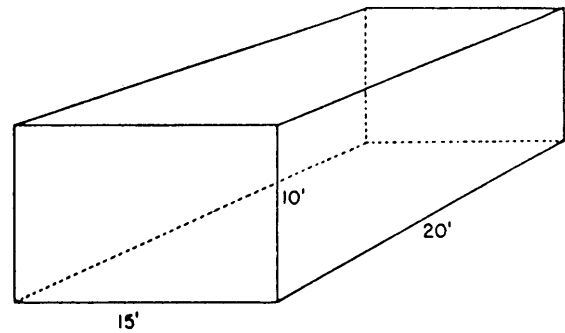

Figure 12-4.-Rectangular space.

Unfortunately, all storage spaces are not this easy to figure. Many times there are coils, pipes, lights, and required passageways or aisles that prevent you from using all the space. You cannot pack or store food items up to the overhead or from bulkhead to bulkhead because room for ventilation and access to the food items must be provided.

For example, a storage space 22 feet 6 inches long, 14 feet 3 inches wide, and 9 feet 9 inches high is shown in figure 12-5. There are coils extending out 6 inches

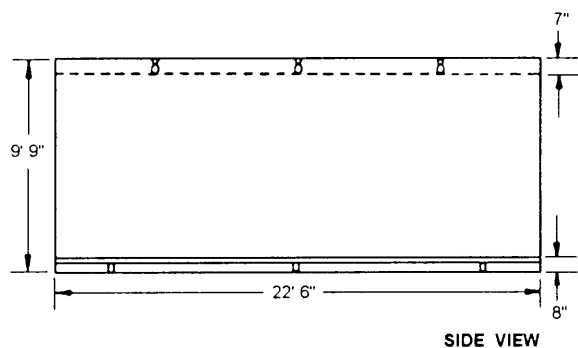
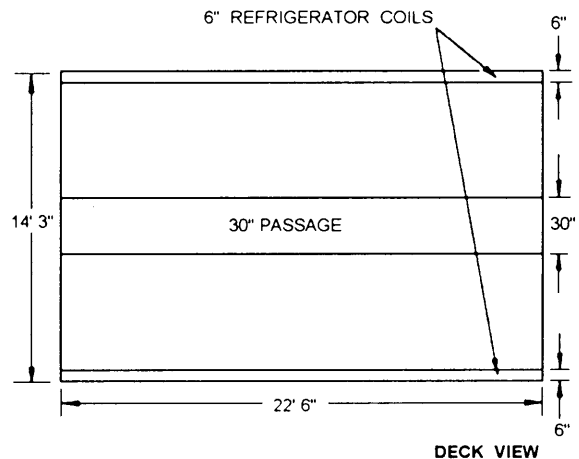

Figure 12-5.-Space with obstructions.

from the bulkhead along both the long sides of the space. Also, a 30-inch passageway should be provided down the center of the space. Study figure 12-5 and notice the allowances that will have to be made for the coils and passageway. In addition, the lights extend down 7 inches from the overhead, and gratings 8 inches high were placed on deck as shown in figure 12-5, the side view.

To find the cubical capacity of this storage space, write down the actual dimensions of the space. Then subtract the dimensions of the allowances you will need to make, like this.

22'6"	Total length	14'3"	Total width	9'9"	Total height
	less	- 2'6"	Passage	- 7"	Lights
		- 1'	coils	- 8"	Gratings
22'6"	Usable length	10'9"	Usable width	8'6"	Usable height

Using the new dimensions, proceed as before.

$$22 \frac{1}{2} \times 10 \frac{3}{4} \times 8 \frac{1}{2} = 2,055 \frac{15}{16} \text{ cubic feet.}$$

You may have a storage space shaped like the one shown in figure 12-6. First, you will have to get the average width by adding the two widths together and dividing by 2.

$$\frac{12' + 20'}{2} = \frac{32'}{2} = 16 \text{ feet.}$$

Then complete the problem by multiplying this average width by the length and by the height.

$$16' \times 16' \times 10' = 2.560 \text{ cubic feet.}$$

Special Space Problems

Some food items, such as frozen meats, should be kept in a special type of storage. The capacity of these spaces limits the amounts you may order.

When planning for an extended cruise, you may find that freeze space on your ship is not adequate to store the total meat requirements. You will want to load

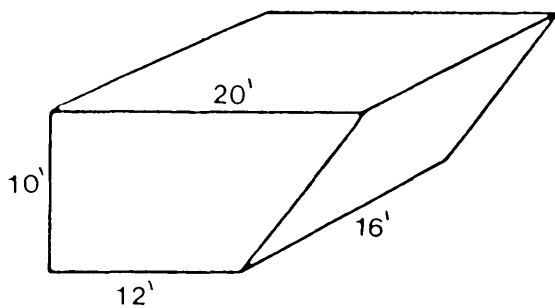

Figure 12-6. Irregular space.

canned meats to supplement your frozen meat supply. The Table of Substitution Factors for Custom Foods lists the factors to use when converting pounds of frozen meat items to canned meat counterparts. This table can be found in the NAVSUP P-486, volume I, appendix G.

REQUISITIONING FOOD ITEMS

GMs ashore and ships in port normally submit requisitions for authorized food items found in the FSC to the nearest naval supply support activity. Deployed ships should submit requisitions to a store ship (AF), combat store ship (AFS), fast combat store ship (AOE), or other afloat activity. When normal sources are not available, food items may be procured by transfer from other military sources and the United States Government departments. Food items such as fresh dairy products and commercially prepared bakery products, as authorized, normally are procured in the United States by placement of delivery orders against indefinite-type contracts. Material is taken up as a receipt from purchase. Brand name contracts (Defense Logistics Agency Supply Bulletin, SB10-500) are not authorized for use in procuring food items for the GM. Further information concerning sources of supply, procurement, and local restrictions are contained in the Procurement section of the NAVSUP P-486, volume 1.

The bulk of your food items will be procured by submitting requisitions using the DOD Single Line Item Requisition Document, DD Form 1348 or 1348m, or applicable requisition documents as required by the supply support activity.

Mechanized Method

Nonautomated activities receiving semiperishable food items from a mechanized supply activity within the United States are provided prepunched and interpreted decks (computerized cards) of the DOD Single Line Item Request Issue Document (Mechanical), DD Form 1348m, for all semiperishable food items authorized for use in Navy GMs.

Automated customer activities do not receive prepunched decks of DD Form 1348m from the supply point. Such activities prepare their own requisitions. Any requisitioner may choose to submit manually prepared requisitions using the DD Single Line Item Requisition System Document (Manual), DD Form 1348.

Supply activities with mark-sensing equipment may vary local procedures as necessary for maximum usage of mark-sensing capability. However, the requisition cards should be of a type and format universally acceptable to all mechanized activities.

DECK ARRANGEMENT.– The cards in the requisition decks are arranged in the order in which the items appear on the Food-Item Report/Master Food Code List, NAVSUP Form 1059. The three-digit code number in the last three columns of the serial number field (card columns 41-43) provides a simple alphanumerical order of arrangement.

PHYSICAL CONDITION AND UPDATING.– The requisition cards should be maintained in perfect physical condition. Frayed, torn, or bent cards will cause delay in processing and may delay delivery of material. You should request a replacement for any card that is distorted. New cards received from a supply activity should be filed promptly in the requisition decks, and cards are removed immediately upon request of the supply activity.

ROUGH REQUISITIONS.– A rough requisition will be prepared on a Food-Item Report/Master Food Code List, NAVSUP Form 1059, by inserting the following information:

- The Julian date in the upper right corner
- The quantity desired under Quantity (even case quantities are requisitioned except items such as condiments that the support activity authorizes for issue in broken case lots)

This rough requisition is used to prepare smooth requisitions on the prepunched DD Form 1348m and serves as a retained record of requisitions submitted. The rough requisition is filed in the outstanding requisition file. It maybe used when material is received to identify and check receipts.

SMOOTH REQUISITIONS.– To prepare smooth requisitions, the requisitioner pulls one prepunched DD Form 1348m from the requisition deck for each item required and inks in (do not punch) the following data on each card–the quantity desired is transcribed from the rough requisition.

Card Columns

- 25-29 Quantity desired (in even case lots).
- 36-39 Julian date (digit calendar year and date).
- 46-50 Use of this block is optional. It maybe used to provide delivery information to receiving and storage personnel.
- 62-64 RDD (required delivery date).
- 65-66 Advice code. Optional.

SPECIAL REQUISITIONS.– Requisitions that require data in the Remarks blocks are manually prepared on DD Form 1348. These may include requisitions for nonstandard items, special project material, composite packages (combat meals), material for which special accounting data should be provided, and emergency requisitions that require special handling.

REQUISITION CONTROL RECORD.– Prepare the requisition control record (fig. 12-7) on a machine card size and submit it as a cover letter with each lot of prepunched requisitions. The requisition control record contains the following information:

- To: The supply activity.
- From: The requisitioning ship or activity.
- Semiperishable food items: as a title.
- Number of requisitions: The total number of requisitions forwarded with this cover letter.
- Date of requisitions (Julian): The date that the requisitions are delivered or forwarded to the supply activity.
- Required delivery date (Julian): The required delivery date should be realistic and provide adequate time for routing processing and delivery. Ships may enter an earlier than normal required delivery date when necessary and explain beneath the date either “Based on scheduled deployment” or “Based on availability of pier space.”
- Signature: The requisition control record will be signed by the FSO of the requisitioning activity or by his designated representative.

TO:	FROM:
SEMIPERISHABLE FOOD ITEMS	
Number of requisitions _____	
Date of requisitions (Julian) _____	
Required delivery date (Julian) _____	
_____ Food Service Officer Signature	

Figure 12-7.–Requisition control record.

Manual Method

All the entries made on the DD Form 1348 (fig. 12-8) should be entered using a ball-point pen or typewriter when preparing a manual requisition.

When preparing requisitions, it is not necessary to space the entries within the tic marks printed on the form. However, it is important that entries be prepared by the requesting ship according to the Procurement section of the NAVSUP P-486, volume I.

REQUISITION LOG.- Maintaining the Requisition Log, NAVSUP Form 1336, is optional for all ashore and afloat activities. The requisition log provides requisition documentation control and information on outstanding requisition documents and receipts. It also provides a breakdown of receipts with and without charge. Outstanding requisitions that are brought forward to the current month's requisition log should carry the same requisition document numbers assigned on the previous month's log.

Instead of maintaining the Requisition Log, NAVSUP Form 1336, all receipts without charge may be annotated with W/O in the left-hand margin on the NAVSUP Form 367. At the end of each month, the receipts with charge file will be used as the source file for determining the dollar value of the Receipts With Charge block for the monthly NAVSUP Form 1357. This value also can be confirmed using the NAVSUP Form 367 by totaling all receipts not annotated W/O.

REQUISITION FILES.- You should maintain a requisition file that contains a copy of each procurement

document generated for each outstanding requisition. You should maintain an outstanding requisition file for all DD Forms 1348 and 1149 and rough requisitions, NAVSUP Forms 1059. For all DD Form 1155 purchase orders, you also should maintain an outstanding purchase order file. You should maintain these forms in document number sequence within their individual files. Only the records keeper is required to maintain completed requisition or purchase order files.

PURCHASING

When it is not possible to procure food items from normal sources of supply, they maybe purchased under existing shore contracts or in the open market. In general, contract bulletins and local regulations should furnish you with the necessary information concerning commercial sources of supply.

Contract bulletins issued by Navy purchasing activities are the official source to determine that the contract under which an order is to be placed (1) is in existence and covers the specific product required and (2) provides for delivery at the particular port or area when delivery is requested.

Do not rely upon pamphlets or lists furnished by suppliers since they may contain errors. If you place orders based upon information contained in these pamphlets without confirmation against contract bulletins, they may result in the unauthorized placement of orders or disallowance of payment by the Navy Regional Finance Center (NRFC) or Fleet Accounting and Disbursing Center (FAADC).

DOC NO	ROUTING	FSC	NIN	ADD	QUANTITY	DOCUMENT NUMBER	DATE	SERIAL	SUPPLEMENTARY	FUND	PROJECT	REQ DATE	ADV
SEND TO	STOCK NUMBER	DOCUMENT NUMBER	REQUISITION IS FROM	NSC, SAN DIEGO, CA	N00244	USS NEVERSAIL (HH-1)	R 00000						
A	COFFEE	DOC IDENT	ROUTING	M B S	STOCK NUMBER	ADDN	UNIT OF	QUANTITY					
B	AOA N D Z	3	8	9	5	0	0	2	8	6	5	3	7
C	R 0 0 0 0 0 6 0 8 0 9 P 2 9 R Y	A											
D	P Z	9	M	1	3	G	H	I	J	K	L	M	N
E	APPROVED BY:	C. P. Lambert	LT, SC, USN										

Figure 12-8-DD Form 1348.

The following paragraphs discuss the general purchase regulations, purchase under existing shore contracts, open market purchase, and the use of the Order for Supplies or Services/Request for Quotations, DD Form 1155.

General Regulations

The following rules apply to all purchases of food items:

1. Food items authorized for use by your ship or station may be purchased under monthly, quarterly, or annual contracts if the items cannot be furnished from a normal source of supply.

2. The Department of Agriculture controls the entry of certain foreign-grown fruits, vegetables, and meats into the United States through absolute quarantine. Therefore, in the procurement of meats, fruits, and vegetables in foreign waters, only such quantities should be taken on board as will be consumed completely before arrival in home waters. Inform the senior medical department representative when any purchase is contemplated.

3. Do not order for use in the GM any brand name article, food substitute, or other item on which competition is restricted.

4. Order perishable food items well in advance of the time set for sailing. You may need the additional time to replace items that are not according to specifications.

5. Use the bakery facilities and equipment of your ship or station to capacity. Keep purchases of commercial bakery products to a minimum.

Purchasing Under Existing Shore Contracts

When you are purchasing food items that ordinarily are not in stock at the normal sources of supply ashore, such items should be procured by the supply officer of the shore supply activity with whom the requisition was placed.

The Order for Supplies and Services/Request for Quotation, DD Form 1155 (fig. 12-9), should be used when you are purchasing under existing indefinite or definite contracts. When you are preparing a DD Form 1155, make sure all the captions are filled in correctly and verify against contract bulletins before placing orders. Also, make sure the contract number is clearly shown in the proper place on the form.

Complete information on the preparation of the DD Form 1155 for definite or indefinite deliveries can be found in the Procurement section of the NAVSUP P-486, volume I.

The FSO should keep two completed receipt copies, with the inspector's signature, of all orders for delivery of food items under lock and key until the bills to which they pertain have been received.

Local Purchases

Local purchases for ashore GMs use are authorized only through local supply support activities. Activities afloat normally may not purchase food items from commercial sources for GM use. If food requirements cannot be secured from regular supply sources (such as a local supply activity, an indefinite delivery contract, and transfers from another military service or from ship's stores), local purchases may be made by the supply officer, subject to limitations imposed by the senior officer present, of approved items providing:

- there is an immediate need and urgent requirement for authorized supplies or services;
- the supplies or service are not available at the local supply support activity; and
- time is of the essence and scheduled operations may not permit procurement through Navy shore-based purchasing activities.

Fleet fast pay is a procedure that allows fast payment under limited conditions to a contractor before the government's verification that supplies have been received and accepted. Fast payment procedures are used for food supplies only. The procedure provides for payment for food supplies based on the contractor's submission of an invoice that constitutes a representation that:

- the supplies have been delivered to a point of first receipt by the government; and
- the contractor agrees to replace, repair, or correct supplies not received at destination, damaged in transit, or not conforming with purchase agreements.

The ship will not receive a dealer's invoice nor should it present any documents showing receipt and acceptance to the paying office or to the supporting supply activity ashore before payment for material ordered under the fast payment clause.

The consignee's (GM) copy of the purchase order will contain the following instruction:

"Consignee's notification to purchasing activity of nonreceipt, damage, or conformance." The consignee shall tell the purchasing activity promptly after specified date of delivery in the

ORDER FOR SUPPLIES OR SERVICES				Form Approved OMB No. 0704-0187 Expires Jul 31, 1989		PARTITION 1		
1 CONTRACT PURCH ORDER NO DLA-13H-93D-W372		2 DELIVERY ORDER NO		3 DATE OF ORDER 93 MAR 01		4 REQUISITION PURCH REQUEST NO V05504-3060-9W66		
5 ISSUED BY V05504 USS DUARTE (DD 901) FPO AE 09569				7 ADMINISTERED BY (if different than 5)		8 DELIVERY JOB <input checked="" type="checkbox"/> CASH <input type="checkbox"/> OTHER		
9 CONTRACTOR NAME AND ADDRESS JOHNSON'S BAKERY P.O. BOX 321 NORFOLK, VA 23501				10 DELIVER TO FOR POINT BY (Date) 93 MAR 31		11 MARK BUSINESS <input type="checkbox"/> RETAIL <input type="checkbox"/> SMALL BUSINESS CONTRACTOR <input type="checkbox"/> WOMAN OWNED		
14 SHIP TO USS DUARTE (DD 901) PIER 6 NORFOLK, VA				12 PAYMENT TERMS NET		13 MAIL INVOICES TO SEE BLOCK 15		
15 PAYMENT WILL BE MADE BY N6095452 DIRECTOR DEFENSE FINANCE AND ACCOUNTING SERVICE DEFENSE ACCOUNTING OFFICE - CLEVELAND CENTER 9712 VIRGINIA AVENUE - ATTN. CODE 1E NORFOLK, VA 23511-6096				16 MAKE ALL PACKAGES AND PAPERS WITH CONTRACT OR ORDER NUMBER				
17 DELIVERY <input checked="" type="checkbox"/>		This delivery order is issued on another Government agency or in accordance with and subject to terms and conditions of above numbered contract.						
18 PURCHASE		ACCEPTANCE: THE CONTRACTOR HEREBY ACCEPTS THE ORDER REPRESENTED BY THE NUMBERED PURCHASE ORDER AS IT MAY PREVIOUSLY HAVE BEEN OR IS NOW MODIFIED, SUBJECT TO ALL OF THE TERMS AND CONDITIONS SET FORTH AND AGREES TO PERFORM THE SAME.						
19 NAME OF CONTRACTOR		20 SIGNATURE		21 PRINT NAME AND TITLE		22 DATE SIGNED		
23 ACCOUNTING AND APPROPRIATION DATA								
24	25	26	27	28	29	30	31	
ALL	1731804.2270	000	00031	0	068732	2D	003060	0V0550473170
32	33	34	35	36	37	38	39	
1	BREAD, WHITE, SLICED W66	1000	LB	.631				
"PARTIAL DELIVERY ACCEPTABLE"		Approximate quantity required for the month		Extended price left blank until end of month				
"FAST PAY PROCEDURES APPLY. ORIGINAL OF THIS ORDER MUST ACCOMPANY THE INVOICE AT TIME OF SUBMISSION TO DFAS FOR PAYMENT"		24 QUANTITY ACCEPTED BY GOVERNMENT		25 TOTAL		26 DIFFERENCE		
27 QUANTITY IN COLUMN 30 HAS BEEN <input type="checkbox"/> UNEXPECTED <input type="checkbox"/> RECEIVED <input type="checkbox"/> ACCEPTED AND CONFORMS TO THE CONTRACT EXCEPT AS NOTED		28 SHIP NO		29 DO VOUCHER NO		30 INITIALS		
31 SIGNATURE OF AUTHORIZED GOVERNMENT REPRESENTATIVE		32 PAID BY		33 AMOUNT PAID (CORRECT USE)		34 CHECK NUMBER		
35 SIGNATURE AND TITLE OF CERTIFYING OFFICER		36 COMPLETE <input type="checkbox"/> PARTIAL <input type="checkbox"/> FINAL <input type="checkbox"/>		37 BILL OF LADING NO		38 INVOICE NO		
39 RECEIVED AT	40 RECEIVED BY	41 DATE RECEIVED	42 TOTAL CONTAINERS	43 IN ACCOUNT NUMBER	44 INVOICE NO			

Figure 12-9-Order for Supplies and Services/Request for Quotations, DD Form 1155, used for an indefinite delivery.

purchase order of supplies not received, damaged in transit, or not conforming to specifications of the purchase order. Under extenuating circumstances such notification should be made not later than 30 days after the specified date of delivery.

The paying activity may require periodic reports of receipts and performance of deliveries under fast pay.

Dealers' Invoices

When the dealers' invoices have not been received by your ship or station, your FSO should begin an inquiry 10 days (ship) or 30 days (shore) after receipt of the material, if the purchase authority shows that the dealers' invoices are to be submitted to your ship or station. A dealer's invoice should not be received when

fast pay procedures are used or when receipt inspections are accomplished by another activity.

Before your ship leaves a foreign port, your FSO should prepare and submit for payment all public vouchers covering the dealers' invoices for food items from foreign vendors. If payment of dealers' invoices cannot be made before the ship leaves port, all such invoices, properly certified, are forwarded to the nearest disbursing officer for payment. However, if there is no supply officer with the disbursing facilities in the immediate vicinity, arrangements should be made with the local naval attaché, naval observer, or consular officer to whom the supply officer forwards the public vouchers with certified invoices and three copies of the purchase order so payment can be accomplished.

Dealers' invoices offering discounts upon payment within the discount period are processed immediately after the material is received and forwarded to the NRFC or FAADC designated in the purchase document for preparation and payment of public vouchers. When the dealer's invoices are not forwarded within the discount period because of a fault of the dealer, an explanation may be made on a copy of the dealer's invoice or the inspection report, whichever is used for certification of receipt of the material.

Dealers' invoices not subject to discount are forwarded to the appropriate NRFC or FAADC within 10 days from the date of receipt of the material or the dealer's invoice, whichever is later.

Payment of invoices received from a dealer not located in an area served by the NRFC is made by the disbursing officer of the receiving ship or activity. If a disbursing officer is not available, payment can be made by one of the following offices or centers, whichever or whoever is the nearest:

- Military disbursing officer
- United States disbursing officer (usually assigned to a United States Embassy)
- Nearest NRFC or FAADC

Canadian dealers' invoices are forwarded to the Navy Regional Finance Center, Washington, DC, for payment when a disbursing officer is not available or when no other provisions have been made. Payment is made in Canadian dollars.

In summary, dealers' invoices INCONUS for both afloat and ashore activities are submitted to the nearest NRFC or FAADC. OUTCONUS afloat activities dealers' invoices are paid by the ship's disbursing

officer. On ships without a disbursing officer, the dealers' invoices are forwarded to the nearest disbursing officer or designated disbursing office.

Transfers From Ship's Stores

Only individual-sized serving items; that is, food items packaged in small containers providing one individual serving and authorized for special meals, may be transferred from ship's stores to the GM for use in preparing special meals.

Underway Replenishment

Underway replenishment is a major task. However, this task may be simplified somewhat by careful planning and supervision on your part. The Underway Replenishment Bill is a part of your ship's *Standard Organization and Regulations Manual*. Compare this bill with others that you have used. If the bill can be improved, discuss your recommended changes with your immediate supervisor.

If your ship is attached to an operating force, it will receive most of its support from mobile logistics support groups (AFs).

Listed next are some major points that you should consider when planning underway replenishment:

1. Submit your requisition to the AF within the item limits listed in replenishment guides. This gives the AF ample time to process the requisition.
2. Be sure you are ready for replenishment when the time comes by accomplishing the following:
 - a. Know the replenishment stations.
 - b. Determine the number of cases that will come aboard, how many people will be required as checkers, and how many people will be needed in the working party.
 - c. Be sure all storerooms are ready to receive the stores. This may require stock rotation and storeroom cleanup by the bulk storeroom personnel.
 - d. Plan the traffic routes for the working party to take. (Be sure to indicate a separate return from the storerooms to avoid congestion and confusion.)
 - e. The commanding officer (CO) and executive officer (XO) should be informed of the plans for replenishment.

3. Make sure the working party and the checkers are on station before replenishment begins.
4. Be sure the checkers have a system for checking all actual quantities of food items that come aboard.
5. Be sure the working party stays on the job until all food items are received aboard and stored below in the proper storerooms.
6. Be sure the checkers know where all the items are to be sent for storage. The checkers usually should be MSs.
7. Take necessary precautions to see that items, such as fresh fruits, are not pilfered during the storing operation.

Procurement for Private Messes

Any food items listed in the FSC, as authorized for GM use, maybe requisitioned and held for ultimate sale to private messes. Items listed with restricted usage in the FSC, but not authorized for GM use, are procured only for immediate sale to private messes. Food items not listed in the FSC may be procured for immediate sale by the supply officer, through normal supply channels, to flag and cabin messes only upon receipt of a written request. Such items may be held in stock and issued to flag and cabin messes as required during extended deployments. Food items not authorized for GM use and specifically requisitioned for sale only to private messes may not be returned by the private mess for credit. Requisitions for food items not authorized for GM use are annotated "For sale to private messes."

FOODSERVICE COST CONTROL

GMs provide high-quality meals to authorized personnel. The FSO maintains financial accountability and control of the GM within the allowed monetary budget. Providing high-quality meals within a prescribed monetary allowance requires managerial skills and constant attention from the FSO and the foodservice division.

As a junior MS, you learned the basics of a very challenging rating. As you advanced, your responsibility significantly increased and you now direct more and more of your attention to management. This incidentally is your rating's middle name.

The key to effective management is control. As an MS third or second class petty officer, you learned the importance of portion control; also how it related to effective management on a smaller scale. We will now discuss the control procedures used to manage an

effective operation and how to use the available resources and money to the Navy's best advantage.

Navy GMs afloat and ashore operate on a monetary ration allowance. The allowances represent these dollars and cents called monetary rates. In 1933, the present Navy Ration Law, 10 *U.S. Code* 6082, came into effect. This law (specified in actual quantity of food) is a converted cash equivalency. You can compute this allowance by using the quantitative food allowance prescribed by the DOD Food Cost Index. This is based on food items authorized by the 1933 Navy Ration Law. The 1933 Navy Ration Law is listed by weight (such as 44 ounces of fresh vegetables) and converted to a monetary allowance.

As a senior MS, you should understand not only what a ration is but also the various types of rations used in the Navy. Additionally, you should know which personnel are entitled to rations-in-kind, what forms to use in determining ration credit, and how to determine ration credit afloat and ashore. The NAVSUP P-486, volume I, defines this in detail.

One purpose of a cost control system in a mess is to provide you information on the financial operation of the mess. Cost controls provide the proper detailed information to give you the tools to overcome waste, lack of portion control, unwise menu planning, and/or pilferage; thus, ensuring guidance or restraint over money, material, and personnel.

COMPONENTS OF FOOD COST CONTROL

The following are five elements of cost control:

1. A prescribed operating limit or budget
2. A knowledge by management of the actions and procedures necessary to maintain within the prescribed operating limits of the mess
3. Prompt and accurate information on the daily progress toward maintaining within operating limits
4. The ability of management to rate the information received
5. The ability of management to follow up and take remedial action as necessary

The financial requirements of each activity are subject to circumstances unique to the individual installation concerned.

COMPUTING DAILY FOOD COST

All GMs post total ration credits daily to the NAVSUP Form 338 whether ashore, afloat in port, or afloat at sea. The NAVSUP Form 338 is shown in figure 12-10.

DAILY MONETARY ALLOWANCE PER PERSON

\$5.25
SCFA \$4.75

ENLISTED DINING FACILITY CONTROL RECORD (4061)
NAVSUP FORM 338 (REV. 11-84)

SUPPLEMENTAL/SPECIAL ALLOWANCES
\$0.50

FOR THE PERIOD
1-31 JAN 94

FROM (Name of Ship or Station)

U.I.C.

USS NEVEKSAIL (HH-1)

R00007

DAY OF MO (1)	MEALS SOLD FOR CASH											MEALS FED - RATIONS IN KIND				DAILY (11)	RATIONS CREDIT	MONETARY ALLOWANCE		FOOD COST		OVER/UNDER ISSUES
	B 20% (2)	L 40% (3)	D 40% (4)	N 20/40% (5)	DAILY (6)	B 20% (7)	L 40% (8)	D 40% (9)	N 20/40% (10)	DAILY (11)	R/K CASH SALES DAILY TOTAL (12)	CUMULATIVE TOTAL (13)	DAILY (14)	CUMULATIVE TOTAL (15)	DAILY (16)			CUMULATIVE TOTAL (17)	ONE RATION (18)			
													(18)	(19)	(20)			(21)				
1	6	15	7	0	10.00	35	150	143	0	124.20	134	134	703.50	703.50	608.42	608.42	4.54	95.08				
2	4	15	5	0	8.80	29	162	130	0	122.60	265	265	687.75	1391.25	734.27	1342.69	5.61	+ 6 48.56				
3	5	15	9	0	10.60	31	148	126	0	116.00	392	392	666.75	2058.00	850.63	2193.32	6.70	- 135.32				
4	6	15	8	0	10.10	36	153	140	0	124.40	527	527	708.75	2766.75	534.72	2722.60	3.96	+ 38.71				
5	7	15	9	0	11.20	42	157	143	0	128.40	666	666	789.75	3496.50	675.26	3403.30	4.86	+ 93.20				

EXAMPLE OF OVERISSUE (WRITTEN IN RED INK OR PLACED IN PARENTHESES)

Figure 12-10.-Enlisted Dining Facility Control Record, NAVSUP Form 338.

Ashore activities obtain ration credit information on meals sold and meals fed—rations-in-kind from the Subtotal line of the Recapitulation of Meal Record, NAVSUP Form 1292.

Afloat activities enter the actual number of meals sold whether in port or at sea. These figures are obtained either from the Cash Meal Payment Book DD Form 1544, or the Sale of General Mess Meals, NAVSUP Form 1046. Meals fed rations-in-kind while at sea will be the same as the number of rations allowed daily. The actual head count numbers for each applicable meal will be used to reflect the number of meals fed rations-in-kind.

The following information describes the procedures all GMs must use to complete columns (2) through (19) on the NAVSUP Form 338 (fig. 12-10):

- Columns (2) through (5). Enter the actual number of meals sold in the applicable column. Other meals, such as brunches, will be shown in the column applicable to directions that are provided in the most current NAVSUPINST 4061.9.

- Column(6). Multiply columns (2) through (5) by the applicable ration credit conversion factors for each meal. This conversion factor is shown at the top of each column. Carry the resulting figure out to two decimal places, then add the results and enter the total in column (6); for example:

Breakfast	6 x .20 = 1.20
Lunch	15 x .40 = 6.00
Dinner	7 x .40 = <u>2.80</u>
Total	\$10.00

- Column (11). Multiply rations-in-kind amounts in columns (7) through (10) by applicable ration credit conversion factors and then total these results; for example:

Breakfast	35 x .20 = 7.00
Lunch	150 x .40 = 60.00
Dinner	143 x .40= <u>57,20</u>
Total	\$124.20

- Column (12). Add the figure in column (6) to the figure in column (11). Then enter the results, rounded to the nearest whole number, in column (12). For example, 10.00 + 124.20= 134.20 is rounded off to 134.

- Column (13). Add the figure in column (12) to the preceding day's entry in column (13). Then post the result in the current day's Cumulative Total column (13).

- Column (14). The monetary allowance per person (MAPP) is the amount of the basic daily food allowance (BDFFA) and any supplemental or special allowance (SA). Multiply the number of rations in column (12) by the monetary allowance per person. Then post the result in column (14) as that day's total monetary allowance; for example:

BDFFA	4.75
SA	+ <u>0.50</u>
MAPP	= 5.25
	x 134 (rations-in-kind/cash sales daily total)
	= \$703.50 (that day's total monetary allowance)

- Column (15). Add the figure in column (14) to the preceding day's entry in column (15). Then post the result in the current day's column Cumulative Total (15).

- Column (16). Total cost of rations for the day from the day's issues to the GM, less bakery products sold. Enter the resulting total in column (16).

- Column (17). Add the figure in column (16) to the preceding day's entry in column (17). Then post the result in the current day's column Cumulative Total (17).

- Column (18). Divide column (16) by column (12). Then post the result in column (18).

- Column (19). Subtract the figure in column (17) from the figure in column (15). Then post the result in column (19).

Posting over- and underissues is described next. The over or under dollar value is the difference between cumulative food cost and cumulative monetary allowance. Column (17) is the cumulative food cost and column (15) is the cumulative monetary allowance.

When the figure in column (15) is the greater, an underissue condition exists. This difference is posted in blue or black ink as a plus (+) sign in column (19).

When the figure in column (17) is the greater, an overissue condition exists. This difference is posted in column (19) in either red ink preceded by a minus (-) sign or in blue or black ink enclosed in parentheses.

DETERMINING OPERATING LIMITS

We now know that the Enlisted Dining Facility Control Record, NAVSUP Form 338, provides a daily cumulative record of the financial condition of the GM.

The leading MS uses the data available on the NAVSUP Form 338 for menu planing and for menu revision and adjustment to accomplish the following goals:

- Determining the financial status of the GM before preparing a menu, especially when planning to use high-cost menu items
- Comparing the daily monetary allowance with the daily food cost as a check of the actual cost each day with the authorized cost for the same day
- Relating the actual cost of one ration to the daily menus to determine the relatively high- and low-cost menus and to use that information in planning future menus and to adjust menus that have resulted in excessively high costs

The FSO will check the NAVSUP Form 338 daily to make sure the GM is operating within the authorized allowance. This daily check also makes sure the NAVSUP Form 338 is being posted daily.

Whenever an overissue occurs, immediate action should be taken to determine the cause and eliminate the overissue by a corresponding underissue.

SPECIAL MEAL FEEDING

When specific conditions are met, there is a need for issuing special meals. These meals are issued for consumption aboard aircraft, small craft, or at a duty station away from the GM. The following are the different types of special meals along with a brief description of the conditions that should be met when they are issued:

- **Flight meals.** Enlisted members of the armed services who are entitled to a meal without charge in a GM when permitted or required to fly in Navy or Marine Corps aircraft are issued flight meals without charge. Enlisted personnel who are not entitled to meals without charge, yet have TAD or travel orders permitting or requiring them to fly in Navy or Marine Corps aircraft, are charged for flight meals at the current prescribed rate. Other special provisions applying to flight meals are discussed in the Expenditures and Accounting section of the NAVSUP P-486, volume I.

- **Boat meals.** Boat meals are issued at no charge to enlisted members of the armed services who are entitled to rations-in-kind and are unable to return to the GM for a meal for reasons such as assignment as beach guards or boat crew members. Navy enlisted personnel receiving COMRATS/BAS and officer personnel must pay cash for each boat meal received.

- **Bag lunches** are issued to personnel entitled to rations-in-kind when assigned to duty that prevents them from returning to the GM for a regular meal. When bag lunches are used, they are accounted for as regular GM meals, or as special meals, whichever method is most administratively helpful to the GM.

- **In-transit meals** are for enlisted personnel of the military services that are in a group travel status, including air travel, and are not receiving per diem or COMRATS/BAS. They are entitled to transit meals at no charge when they cannot be fed in the GM.

RESPONSIBILITIES

Discussed next are the responsibilities of both the FSO and the requesting officer in processing requests for and issuing special meals.

Food Service Officer

The FSO is responsible for the following:

- Requisitioning authorized food items required for special meals
- Procuring nonfood items authorized for the preparation of special meals
- Providing the facilities and supervising the preparation of special meals
- Maintaining files of the receipt for flight meals to substantiate billings to foreign governments

ENTITLEMENT CERTIFICATION.— A responsible officer or chief petty officer certifies on the NAVSUP Form 340 the eligibility of the United States enlisted crew members and passengers not receiving per diem or COMRATS/BAS to receive special meals without charge. The officer or chief petty officer lists the name of each individual, meal pass number, and the abbreviated name of the activity to which the person is assigned.

ISSUE PROCEDURES.— The FSO is authorized to issue special meals only when paid for in cash, or when proper certification is acquired. Proper certification

shows that the person who will consume the meal is entitled to a special meal at no charge. The FSO makes sure only the number of special meals is prepared as requested on the signed copy of the NAVSUP Form 340 that is completed by the requesting officer.

At the time of pickup, the FSO or his or her designated representative verifies the completed original NAVSUP Form 340 with the cash collected. All meals issued without charge are justified with a signed certification of entitlement to special meals or a receipt of special meals.

The FSO or his or her designated representative obtains a receipt signature from the requesting officer or the requesting officer's designated representative. This receipt signature goes on the NAVSUP Form 340 when the special meals are picked up.

The FSO or his or her designated representative acknowledges receipt of cash on the working copy of the NAVSUP Form 340 and returns the receipted copy with the special meals to the requesting officer. The FSO then retains the original NAVSUP Forms 340 with the signed certification to prepare the monthly Special Meals Report, NAVSUP Form 1340, with the signed certificate for posting the monthly Ration and Sales Report, NAVSUP Form 1357.

Requesting Officer

The requesting officer is responsible for the following:

- Determining eligibility for special meals
- Preparing the NAVSUP Form 340 for request and receipt of special meals
- Collecting charges for special meals sold for cash
- Endorsing orders for special meals made available to enlisted personnel receiving per diem
- Obtaining signatures on the reverse side of the NAVSUP Form 340 for special meals furnished to enlisted members of foreign governments

The requesting officer (usually the air terminal officer, squadron duty officer, or officer exercising operational control of the flight, small craft, or group travel operation) prepares, in triplicate, the Special Meal Request/Receipt, NAVSUP Form 340.

One signed copy of the NAVSUP Form 340 is then forwarded to the FSO at least 3 hours before the time special meals are picked up from the foodservice office.

The requesting officer receives payment from personnel receiving special meals in one of the following manners:

- Cash in the amounts prescribed by Naval Supply Systems Command instructions.
- Certification by an officer or chief petty officer that personnel are entitled to meals without charge. A list of names, meal passes, or travel order numbers, and the activities to which assigned are provided to support the certification.
- Signed receipt for flight meals (on reverse of NAVSUP Form 340) from foreign personnel.
- Endorsement of travel orders to show receipt.

The requesting officer then makes sure the original NAVSUP Form 340 is completed, showing the breakdown of special meals requested and the signatures of any foreign personnel on the reverse, to provide to the FSO or his or her designated representative at the time of pickup of the special meals.

ACCOUNTING PROCEDURES

When 10 or less special meals are issued during the monthly accounting period, they are accounted for the same as regular GM meals. The accounting procedures discussed next are used only when more than 10 special meals are issued during the monthly accounting period.

The FSO uses either a NAVSUP Form 1282 or a NAVSUP Form 1059 to record the quantity and value of food items required in preparing the special meals. The issue document is priced and extended using fixed prices. This is done at the time of issue. The quantity issued is posted as an expenditure in the Other column of the Subsistence Ledger, NAVSUP Form 335. The issue document should be retained by the FSO pending preparation of the Monthly Special Meals Report, NAVSUP Form 1340.

General

When a flight or operation is canceled or other valid circumstances prevent the use of special meals requested and prepared, they can be returned to the FSO. However, special meals are not returned for credit if more than 3 hours have elapsed since they were issued.

Return of cash for unused special meals, already paid for in cash, is authorized.

Refunds are made by the FSO or his or her representative only upon receipt of a NAVSUP Form 340 prepared by the officer signing the original request for meals. The request should have a notation "Returned for credit" clearly marked on the original. This is used by the FSO to post credit entries to cash accounts.

Components of unused returned special meals should be reused when possible. They need not be taken upon stock and financial records.

Monthly Special Meals Report, NAVSUP Form 1340

A NAVSUP Form 1340 (fig. 12-11), prepared in duplicate, is used to report the number of special meals issued during the month and the cost of food items used in preparing the special meals. This should be the value of all documents prepared for issue of food items used in the preparation of special meals during the month. This value is entered in the Cost of Food Used column. The cost of supplemental food items may be prorated among the meals in which they are served.

The NAVSUP Form 1340 should be completed showing the total meals issued upon certification of entitlement to each government agency and to any foreign enlisted personnel at government expense. This information is taken from the NAVSUP Forms 340, processed during the period covered by the NAVSUP Form 1340. The foreign government and invitational travel order numbers of foreign enlisted personnel under the Military Assistance Program should be shown for foreign issues and should be taken from the Receipt for

Flight Meals on the reverse side of NAVSUP Forms 340 for the period being reported.

The type of aircraft or small craft and its serial or hull number should be shown in the Comment block when applicable. The FSO should sign the NAVSUP Form 1340, certifying that the special meals indicated were issued.

The total value of food items used in preparation of special meals during each accounting period should be entered on the Balance Sheet section of the General Mess Operating Statement, NAVSUP Form 1358, opposite the caption Special Meals under Expenditures.

The original NAVSUP Form 1340 is submitted monthly to NAVFSSO with the Ration and Sales Report, NAVSUP Form 1357. A copy is retained for posting the Record of Receipts and Expenditures, NAVSUP Form 367, and in preparation of the quarterly NAVSUP Form 1358.

If a completed NAVSUP Form 1340 reveals that the cost of food used for any type of special meal exceeds the monetary allowances for that meal, a letter of explanation should accompany the report explaining why the allowances were exceeded and actions taken to prevent reoccurrence.

Cash received for the sale of special meals should be safeguarded and deposited with the disbursing officer. A receipt should be obtained in a Cash Receipt Book NAVSUP Form 470.

In addition to the recapitulation on NAVSUP Form 1340, cash collected, deposited, and due from credit sales is reported on the monthly Ration and Sales Report, NAVSUP Form 1357.

DOD REPORT DD FORM 1340 (REV. 8-76)

PERIOD
1 - 31 January 198 -

U.S.S.

TOTAL
ISSUED
596

COST OF
FOOD USED*
\$ 1,102.60

CASH
SALES
120

TOTAL
ISSUED
22

COST OF
FOOD USED*
40.70

FROM ISSUE DOCUMENTS
MUST NOT EXCEED THE
ALLOWANCES
AUTHORIZED BY CURRENT
NAVFSO NOTICE 7330.
INSURE THAT ALL FOOD
COSTS ARE INSERTED AS
APPLICABLE.

FROM REVERSE SIDE OF NAVSUP
FORMS 340. ATTACH A COPY OF
I.T.O. OR OTHER AUTHORIZATION
DOCUMENT FOR EACH ISSUE

THESE PRICES MUST AGREE WITH
THE RATES ISSUED IN THE
LATEST NAVSUP INSTRUCTION
4061.9 SERIES.

THE TOTAL NUMBER OF MEALS IN
EACH OF THESE COLUMNS MUST BE
IN AGREEMENT (124)

* INCLUDE COST OF FOOD SUPPLEMENTS
** MUST AGREE WITH TOTAL NO. OF MEALS SOLD FOR CASH
*** MUST AGREE WITH NAVSUP FORM 1340
**** MUST AGREE WITH NAVSUP FORM 1340

COMMENTS

FSO SIGNATURE

\$ 137.90

TYPES OF SPECIAL MEALS	MEALS ISSUED UPON CERTIFICATION ENTITLEMENT										TOTAL	CASH SALES	COST OF FOOD USED*
	USN	US-R	US-C	USMCR	USA	USAF	USCG	FOREIGN	FOREIGN	FOREIGN			
SANDWICH MEAL (BOX LUNCH)	327	47	73	24				10	10	120	596	\$ 1,102.60	
BULK ISSUE (FOR PREPARATION ALOFT)													
T93 Swiss Steak	5	3						10	4		22	40.70	
FROZEN FLIGHT MEALS													
SNACK MEALS													
GOVERNMENT	I.T.O. OR OTHER AUTH.	NO. OF MEALS	NUMBER	SALE PRICE	TOTAL								
Vietnam	000146	10	50	.90	\$ 45.00								
Germany	001472	10	28	1.10	30.80								
			46	1.35	62.10								
					TOTAL							\$ 1,143.30	

ACTIVITY NAME, MAILING ADDRESS, AND UIC CODE W/O ALPHABETIC PREFIX MUST BE INSERTED

LIST ALL TYPES OF FROZEN FLIGHT MEALS (WITH APPLICABLE FOOD ITEM CODE) ISSUED/SOLD IN THESE BLOCKS

LIST ANY OTHER TYPES OF MEALS NOT COVERED ABOVE. THIS BLOCK WILL BE USED TO LIST ADDITIONAL MEALS OF ANY OF THE ABOVE CATEGORIES (INSURE THAT THE APPLICABLE CODE (1, 2, 3, 4) IS INSERTED)

LIST SNACK TYPE MEALS

Figure 12-11.-Special Meals Report, NAVSUP Form 1340.

CHAPTER 13

FOODSERVICE MANAGEMENT

As a senior MS, you may be charged with the responsibility of managing a general mess (GM). This could be one of your most challenging and rewarding assignments. During the course of your career, you probably have gained a wealth of knowledge as your responsibilities have increased. At this point, you should understand all phases of foodservice operations for which you have been responsible.

This chapter discusses procedures that are used in combination with your acquired experience and rate-related reference guides to enable you to efficiently manage a GM.

GMs are established to provide Navy personnel with wholesome, nutritious, well-balanced meals through the proper preparation and service of food items. At this point, you should know that you (the senior MS) are responsible for making sure the highest standards of foodservice are upheld.

As the senior MS, you are responsible to the food service officer (FSO) for the efficient management of the GM. You must plan menus, order all food items, schedule deliveries of food items, and check and inspect receipts. You must supervise storage and issue of food items and determine load capacity. You also must administer work schedules for foodservice personnel, assign jobs to the rotational pool personnel, and initiate corrective action to maintain the facilities and equipment. With aid from the medical department, you must administer a training program for the foodservice division in food sanitation. Instruction should be based on the Bureau of Medicine and Surgery's *Manual of Naval Preventive Medicine*, NAVMED P-5010, chapter 1, "Food Sanitation."

FOODSERVICE ORGANIZATIONAL AND PLANNING POLICIES

Messes are operated according to the various laws, directives, regulations, and instructions. Some laws apply to all services while others apply only to the Navy. Some regulations and instructions are Navywide and some are local. As an MS first class or chief, you should be familiar with those that pertain to the operation of your particular GM. It is your job to see that they are enforced.

The procedures contained in the *Food Service Management*, NAVSUP P-486, volume I, establishes policies to administrate, operate, and manage Navy GMs afloat and ashore. These procedures are the minimum that is essential to good foodservice management and are mandatory unless specifically stated as optional. However, these procedures are not limiting when conditions require additional controls. When necessary, heads of supply departments, commanding officers (COs), or higher authority may supplement procedures that do not conflict with the NAVSUP P-486.

The *Foodservice Operations*, NAVSUP P-421, complements the NAVSUP P-486. The NAVSUP P-486 is directed primarily to foodservice administration. The NAVSUP P-421 presents the other half of the picture by providing basic information about such actual food operations as inspection, storage, menu planning, preparation, and presentation.

The NAVSUP P-421 also includes suggestions on how to organize a foodservice division training program. Additionally, it provides detailed information on getting the maximum use of foodservice personnel and resources.

MESSING FACILITY ORGANIZATION

To carry out the purpose of the foodservice division, GM organization requires the efficient arrangement of personnel by functions. This requires dividing the activities and assigning responsibilities and authority to specific individuals within the foodservice division.

GM organization varies according to the mission, physical characteristics, and complement of each ship or station. When prescribed by the type commander (TYCOM), the supply department head prepares a supply department organization manual. This manual contains a description of each component's function within the division. It also assigns areas of responsibility and authority, including tasks of key personnel.

The supply officer prepares an organizational chart for the department. This chart identifies the essential functions and a clearly defined channel of responsibility and authority. An example of a typical organizational

chart for a foodservice division of a small fleet unit is illustrated in figure 13-1.

Records

As described in detail in chapters 2,3, and 12, GM records are used to accomplish the following basic processes:

- Determining provision requirements
- Preparing requisitions
- Processing receipt and expenditure documents
- Conducting inventories
- Maintaining related files and records to account for food items
- Preparing related correspondence, reports, and returns (financial statements)

The Food Service Management (FSM) system automates many of the routine manual foodservice records-keeping functions. The system uses the same terminology, forms, and procedures as found in the manual system. Since the system has been designed with current regulations in mind, the software can be easily used by an individual familiar with manual foodservice records. The NAVSUP P-486, volume I, provides a mandatory checklist and a Navy Food Service Systems Office (NAVFSSO) recommended system access list, which automated activities are encouraged to use.

Further information is available from the Terminal Users' Guide, which is distributed with the software.

This chapter discusses the use of foodservice records as management tools that enable you to more efficiently operate the mess. As the assistant to the FSO in the GM, you should not have custody or control over original financial records applicable to operating the GM. However, you should have access to these records and may have duplicates, as needed, for the effective administration and operation of the GM.

Throughout this chapter the various processes of foodservice management are discussed. Additionally, examples of how GM records are used to assist in managing all areas of the GM are provided.

Food Preparation

The FSO is directly responsible for making sure foodservice personnel follow all section orders concerning the proper preparation of food. As the leading MS, you should make sure the FSO's orders and regulations are followed by all foodservice personnel.

In addition to the service of food, these orders and regulations encompass such specifics as food conservation, sanitation, scullery operation, and the handling of food wastes. Managing these processes requires setting up a strict routine for preparing and serving food. This routine should include some of the following actions:

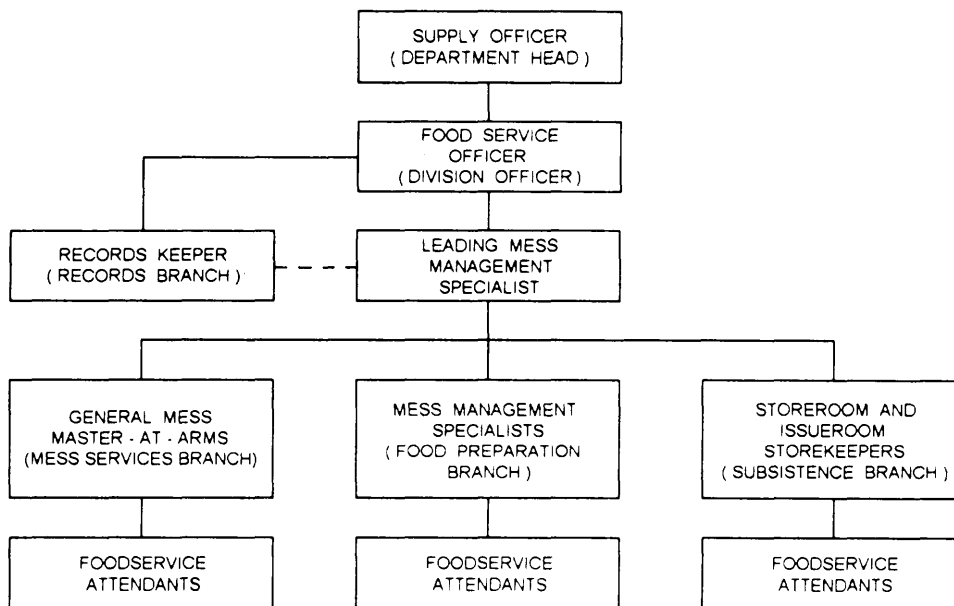

Figure 13-1. Typical organization of a foodservice division of a small fleet unit.

- Giving all foodservice personnel instructions that apply specifically to their duties
- Making sure all foodservice personnel are in clean uniforms (usually white) and maintain the highest personal grooming standards
- Instructing foodservice personnel concerning proper serving techniques before serving meals
- Inspecting and sampling the foods served in the GM
- Training foodservice personnel in the proper preparation of food

In addition to normal feeding, various conditions require situational feeding. All foodservice personnel should be capable of preparing and serving meals under these diverse conditions.

NORMAL CONDITIONS.– As the leading MS, your presence during all meals is essential to the foodservice operation. The fact that you are there and paying close attention to all the work being done has a positive effect on both the foodservice personnel and patrons.

The following are some of the reasons the leading MS's presence in the foodservice spaces is important during the meals:

- Making sure all personnel receive attractively presented, appetizing, and nutritious food served in a pleasing manner
- Making sure the GM patrons are not distracted during the meal
- Handling customer complaints on the spot
- Making sure visitors do not receive tours of foodservice and dining spaces during meal hours
- Preventing circumstances that may upset the normal dining routine or ambiance from occurring during normal meal periods

To make sure the serving area runs smoothly, you should make sure a current menu with nutritional information exists in full view at the beginning of each serving line.

You should make sure food is served promptly and in an appetizing manner. Additionally, you should make sure the equipment on the serving line operates at the proper temperature.

You should place an MS in charge of each serving line. This individual should be capable of instructing foodservice personnel on all aspects of the serving line operation.

SITUATIONAL FEEDING.– You should make sure your facilities, personnel, and schedule are flexible enough to support any required situational feeding. Situational feeding refers to the various types of special meals, battle feeding (combat feeding), or emergency and disaster feeding.

Special Meals.– Personnel required to work through normal meal hours, due to the nature of their duties, must receive a chance to eat. They are usually provided special meals, which were discussed in chapter 12.

Battle Feeding.– Aboard ships, food is distributed to battle station lockers for use during battle feeding situations. Food that does not require galley preparation or semiperishable food distributed in this manner requires constant checking. You should check to make sure all food items are rotated periodically to prevent spoilage, misuse, or theft.

During battle stations, personnel must man their stations until secured. Because battle stations may last for some hours, food carriers, racks, trays, and large coffeepots should be available to support battle feeding needs.

Battle food preparation will depend on whether the galley is in operation and enough MSs are available. If neither the galley nor enough personnel are available, you should use the meal ready to eat (MRE) ration and supplement it with hot or cold drinks. If limited galley foodservice is available, you should plan simple menu items. Simple menu items include sandwiches, fresh or canned fruit, hot canned beef stew, chili con carne, or easy to prepare recipes. You should supplement these meals with hot or cold drinks.

Personnel being relieved from battle stations should go to the galley or other auxiliary feeding stations to receive hot food. You should set up auxiliary feeding stations when situations do not allow access to the galley.

Officers receiving meals from the GM during battle feeding situations must pay regular meal rates as stated in NAVSUPINST 4061.9. Selling meals to officers on a credit basis simplifies procedures during an emergency situation.

Emergency and Disaster Feeding.– Historically such disasters as hurricanes, flooding, earthquakes, volcano eruptions, or accidents at sea have occurred.

Military activities have found it necessary to feed survivors of such disasters. As the leading MS, you should be familiar with your command's disaster preparedness contingency plan, which should include specifics on how to set up and feed the victims of disasters. You also should know how to properly account for the feeding of these personnel. Accounting procedures for emergency and disaster feeding is covered in the Expenditures and Accounting section of the NAVSUP P-486, volume I.

There are two classes of survivors of disasters used for accounting purposes. These classes are destitute survivors of disasters and survivors of disasters having personal funds.

1. Destitute survivors of disasters include refugees, civilian evacuees, and American merchant seamen. They are conditionally entitled to rations-in-kind and may be fed in Navy GMs at sea. The CO must first determine that the survivors are in fact destitute. The issuing command should use a locally prepared form to furnish information establishing entitlement of rations issued. This letter (fig. 13-2) is

called the certification of rations issued form. The Ration System section of the NAVSUP P-486, volume I, furnishes instructions on the completion of this form.

Ration credit is taken for destitute survivors of disasters in the same reamer as for rations-in-kind personnel. They are recorded on the monthly Ration and Sales Report, NAVSUP Form 1357, under Ration Breakdown. Code 14 is used to designate the type of personnel receiving rations as disaster survivors.

2. Survivors of disasters having personal funds are authorized to eat in the GM on a cash basis and must pay cash for each meal they receive. The rates charged for these meals are either those published in the NAVSUPINST 4061.9 or current prices established under the item pricing system. You should make every effort to collect cash from these personnel at the time of sale.

This class of personnel requires written authorization to receive rations from the GM. This authorization may be included in the supply department or command organization manual. Charges and

<p>From: _____</p>	<p>_____</p> <p style="text-align: center;">(UIC)</p>
<p>To: Commanding officer, Navy Food Service Systems Office, F2 Washington, DC 20374-1662</p>	
<p>Subj: CERTIFICATION OF RATIONS ISSUED REQUIRING REIMBURSEMENT</p>	
<p>1. Certification has not been received for rations issued as follows:</p>	
<p>a. Date(s) issued _____</p>	
<p>b. Number of personnel receiving rations _____</p>	
<p>c. Number of rations issued _____</p>	
<p>d. Type of personnel _____</p>	
<p>c. Authority to subsist _____</p> <p>_____</p>	
<p>f. Activity and address to bill _____</p> <p>_____</p>	
<p>g. Appropriation to charge _____</p> <p>_____</p>	
<p>(Signature)</p> <p>_____</p>	<p>(Social Security No.)</p> <p>_____</p>
<p>(Grade/rate/title)</p>	<p>(Service/Country)</p>

Figure 13-2. Certification of rations issued form.

accounting procedures for this class of personnel are described in the Expenditures and Accounting section of the NAVSUP P-486, volume I.

Disasters and/or emergencies also may occur ashore and in port. To feed personnel under such conditions, the CO must issue a directive declaring an emergency or disaster exists, and subsistence must be provided to persons other than those normally authorized to subsist.

The following actions should be taken to refund the Navy for meals furnished to victims of such a disaster:

- Individuals should be requested to pay (the sale of meal rates) at the time of receipt of the meal. If collections cannot be made, appropriate information such as name, address, and signature should be obtained. Individuals also should be informed that collection may be effected later.

- If unable to collect from individuals, then reimbursement should be obtained from one of the following organizations:

The American Red Cross

Navy Relief

TYCOM disaster relief funding

A business (contractor responsible for causing an evacuation)

Other disaster relief organizations

- FSOs finding collection efforts from ashore sources unsuccessful should request permission to waive collection. This request should be made to the Navy Comptroller (NAVCOMPT) through the chain of command. Should NAVCOMPT grant approval, the activity's Operations and Maintenance, Navy (O&M,N) fund will be charged the cost of feeding the individuals.

Catastrophic disasters or emergency feeding ashore or in port usually requires feeding large numbers of personnel. This is especially so if multiple supporting ships or stations are involved. A responsible officer in command, normally the local area commander, must issue a directive declaring that an emergency exists. Then subsistence may be provided to personnel other than those normally authorized to be subsisted. Under these circumstances, ration credit should be taken as previously described unless otherwise directed by NAVFSSO. NAVFSSO should be immediately contacted for guidance on the proper accounting and feeding procedures for these personnel. This is because the size of the operation may require unusual

management actions or clarification to ease resolution for involved activities.

Subsistence

All bulk subsistence storerooms including refrigerated storerooms used to keep chilled and frozen food are accountable spaces. The subsistence issue room, if used, is also an accountable space. These storage spaces must be maintained in an orderly fashion. Food items must be stored according to appendixes I and J of the NAVSUP P-486, volume I, and NAVMED P-5010-1.

A jack-of-the-dust must be appointed to be responsible to the accountable FSO for the safekeeping of all food stored in these spaces. Even small ships with few MSs should assign a jack-of-the-dust this primary responsibility. This is a full-time job that involves receiving, storing, and issuing subsistence, and completing all the appropriate documentation. All food in these spaces must be recorded on the inventory cards maintained by the records keeper.

Special Use of the Messdecks

Under certain circumstances, functions other than messing may periodically be held in the dining area of a GM. This is so regardless of how large or small a messing facility may be. These circumstances may include training, meetings, or special events that include games and contests.

You should make sure all events of this nature are coordinated and scheduled. Coordination involves informing key personnel such as your chain of command and any other personnel that may be affected. You should schedule all events so normal routine is not interrupted. This includes the proper and timely preparation for meal service, actual meal service, and cleaning up after meal service.

NAVY FOOD SERVICE SYSTEMS OFFICE GUIDANCE

NAVFSSO has two main responsibilities. NAVFSSO establishes and monitors all policies, procedures, programs, and regulations concerning the management, administration, and operation of all Navy GMs and afloat private messes. Volumes I and II of the NAVSUP P-486 contain detailed information on the administration of GMs and afloat private messes respectively.

When requested, NAVFSSO also will provide aid to activities in solving all major problems encountered in managing or operating enlisted or private messes. Contact points are issued by NAVFSSO instructions in the 5000 series.

NAVY FOOD MANAGEMENT TEAM ASSISTANCE

Excellence in foodservice is essential to the health and morale of Navy members and to the overall readiness of the Operating Forces. Because food is a major item of expense, use of the best food management practices (conservation, preparation, and serving) is necessary.

Navy food management teams (NFMTs) use on-the-job training to provide foodservice personnel with skill in preparing and serving food. This significantly improves the overall Navy foodservice program.

Organization

The NFMTs are directly responsible to NAVFSSO for performance of their mission. The team members may be assigned for additional duty to the host command for military and administrative purposes.

Mission

The NFMTs' mission is to aid ships and ashore activities in raising the quality and standards of foodservice. This assistance is provided in the following manner:

- Participating in an advisory capacity in managing the local foodservice program by working along with foodservice personnel. Demonstrating proper techniques in all phases of foodservice. This includes management, production and serving of food, sanitation, training, and accounting. Their training also motivates foodservice personnel toward increased efficiency and effectiveness.

- Providing on-the-job training to foodservice personnel through the "do as I do" method of instruction, employing advanced training aids and techniques.

- Instilling management awareness in responsible foodservice personnel. Placing special emphasis on high-quality food preparation, progressive cookery, proper serving techniques, foodservice safety precautions and operating procedures, fire prevention, sanitation, and personal hygiene.

- Inducing and stimulating professional pride in foodservice personnel.

- Reviewing the use of facilities, equipment, personnel, and other foodservice resources to evaluate each GM visited. Identifying limitations that hamper fulfillment of the foodservice goal.

- Reviewing manual and automated foodservice records, organization and operating manuals, and financial returns to determine compliance with the *Naval Supply Systems Command (NAVSUP) Manual* and current foodservice directives.

- Evaluating and aiding in implementing foodservice policies and procedures established by the Department of Defense, the Department of the Navy, and commands.

- Aiding in developing patron foodservice education programs to make sure personnel understand the foodservice operation, especially conservation.

- Providing information on and demonstrating new developments in foodservice and food items.

- Evaluating the practical application of foodservice techniques. Imparting programs of instruction, curricula, and formal training through technical and on-the-job training, and thereby making necessary recommendations to NAVFSSO.

- Exchanging ideas on foodservice operations with activities visited. Sending new ideas to NAVFSSO for dissemination to other NFMTs and field activities.

- Recording observations to provide a basis for follow-up actions to aid in resolving problems beyond the control of the local foodservice management personnel through better use of material and financial resources.

After an NFMT visit, no report of discrepancies is made to higher authority.

Requests for Navy Food Management Team Assistance Visits

Activities are highly encouraged to request foodservice training assistance visits. A team visit usually lasts for 2 weeks. Shorter visits maybe arranged if operating schedules or scope of foodservice operations dictates. An example is a ship desiring a visit to address specific problem areas. Team visits normally should not be requested during yard overhaul, while underway, or before shakedown periods of newly

commissioned ships. This is because maximum benefits are not gained during such periods. Those activities desiring aid should submit a letter request (fig. 13-3), showing several periods that may be convenient for the visit.

Activities requesting assistance are encouraged to communicate with the officer in charge of the NFMT within the designated area of responsibility before a visit. This is done so that the following information can be provided to the team before the visit:

- Location of the ship during the requested dates
- Summary data on the supply officer, FSO, and leading MS, such as rank or rate, name, date reported aboard, and projected rotation data

- Any specific problem areas requiring special attention
- Quantity of MSs and foodservice attendants on board
- Available government berthing if the visit is outside the team's home port

NFMTs also conduct training in the following areas:

- Maintaining of general mess records and preparing of GM returns
- Monitoring the contractual messmen program at ashore GMs
- Conducting the Ney Memorial Awards Program

Department of the Navy
USS DUARTE (DD-901)
FPO San Francisco 96601

15 Jan 1993

From: Commanding Officer, USS DUARTE (DD-901)

To: Commanding Officer, Navy Food Service Systems Office, Washington, DC 20374-1662

Subj: NAVY FOOD MANAGEMENT TEAM ASSISTANCE VISIT

Ref: (a) NAVSUP Pub 486, vol. I, appendix N, par. 3.4

(b) Phoncon FSO, USS DUARTE/OIC, Food Management Team, San Diego, CA of, 10 January 1993

1. In accordance with references (a) and (b), a Navy food management team assistance visit is requested during the period 15-30 April 1993. An alternate period is 1-15 May 1993.

R. G. DODSON

copy to:

OIC, NFMT San Diego

TYCOM/Major Claimant

Figure 13-3. Sample letter requesting food management team assistance.

Foodservice assistance is also provided to officers' and chief petty officers' messes afloat.

Report of Visit

After each visit, the officer in charge of the NFMT will informally discuss the overall condition of the GM with the CO or an appointed representative. The supply officer, the FSO, and key foodservice personnel are also briefed on their findings. The officer in charge of the team also submits a summary of the visit to the CO of NAVFSSO. This is done via the CO of the visited activity.

THE PROCESSES OF FOODSERVICE MANAGEMENT EFFICIENCY

Whether afloat or ashore, you, as a senior MS, will be responsible for managing many processes related to foodservice. Foodservice management efficiency entails giving each process related to foodservice the proper attention. You must formulate plans, coordinate the duties, and supervise your personnel's work as well as assume responsibility for the results. You must get the work done by directing and controlling the activities of others so they work together efficiently.

The following are some of the processes related to foodservice that are discussed in this chapter:

- Following the basic standards of foodservice
- Using proper inventory control and accounting procedures
- Setting up a sanitation program that includes physical examinations, training, and inspections
- Conducting routine preventive maintenance

STANDARDS OF FOODSERVICE

Quality of foodservice and customer service contributes substantially to maintaining high morale and the general welfare of Navy personnel. GM patrons are entitled to properly prepared, wholesome, well-balanced, and satisfying meals served under sanitary conditions in a pleasant atmosphere. To this end, the *Standards of Food Service*, NAVSUPINST 4061.11, outlines concrete actions that protect patron health and enhance satisfaction. They should be regarded as basic to any GM operation and serve as a guide for all GM operations.

Monitoring Food Preparation

The success or failure of a meal depends a great deal on properly timed cooking. For example, if chops or similar meats are to be served, cook only enough to get the meal started. Then continue preparing the chops during the serving, keeping just ahead of the demand. As the end of the serving line approaches, make an accurate count of how many servings will be needed to avoid preparing wasted rations.

Many items lose their taste or attractiveness if they are prepared too far in advance or in large quantities. It is good management to implement and enforce progressive cooking practices. Accurate computations on the NAVSUP Form 1090 will enable your MSs to prepare the proper amounts of food. You should keep a record of the amounts of all foods needed to serve each meal. Be sure you get a correct count on the number of people who are ashore on liberty or absent for other reasons. These records serve as a basis for more accurate future calculations.

Insist that your MSs carefully weigh the quantities of food to be used. Otherwise, accurate calculations are a waste of time. You also should monitor the following tasks to include conservation in preparation:

- The proper cleaning and paring of vegetables eliminate considerable waste,
- When you are opening cans, make sure the contents of each can are examined carefully before they are emptied into a large container. The spoiled contents of one can will make a whole kettle full of canned food unfit to serve. Food of questionable quality should be treated as bad food.
- Make sure vegetables are not overcooked. Cooking should end just as soon as the vegetables are tender. Longer cooking destroys food value and appearance.
- Make sure all fresh vegetables to be used uncooked in salads are thoroughly chilled. They should be kept in the refrigerator until it is time to prepare them. After they are prepared, they should be placed back into the refrigerator to keep them crisp and fresh. Do not put the dressing on a salad until just before it is served or the dressing may make the fruits and vegetables wilt.

The senior MSs of both watch sections should jointly conduct a weekly critique of the past weeks menu with all the junior MSs tasked with preparing the meals. During the critique, specific improvements needed in food preparation should be discussed, based

upon recent experience, regarding the coming week's menu.

Control and Documentation of Leftovers

The world's finest foods are provided for the Navy, but the food budget is not unlimited. It's up to you to help keep it within reasonable limits. Waste is one way to send costs shooting skyward. Conservation is the simplest way to keep costs under control. As the person in charge of a GM, you should make it a matter of pride to have a low record of spoilage and leftovers.

You can eliminate waste by planning your menus carefully. Remember, your past food-preparation worksheets contain information on the successes or failures of your past menus.

Note the amount left on trays and listen to the patrons' comments. If there are complaints, find out why the meal did not appeal to them.

Compliance With Recipes

All Armed Forces Recipe Service (AFRS) recipes have been tested and evaluated for militarywide acceptability and to support current nutritional

standards. The use of the AFRS is required and is issued to all GMs to standardize and improve food prepared and served. Standardized recipes are needed for a well-run foodservice operation. The success of the AFRS depends upon its careful use and attention to detail. The AFRS also is the most effective management tool you can use for guiding the requisitioning of supplies and controlling breakouts and inventories.

FoodService Suggestions

One of your responsibilities as leading MS may be to act as the customer service representative to the FSO. In this capacity you must be present in the mess area to answer patrons' inquiries and to receive their suggestions or comments during each meal.

A suggestion box also should be prominently posted at each exit for the convenience of the patrons. This suggestion box should have a pencil or pen attached and have Suggestion to the Food Service Officer, NAVSUP Forms 1343 (fig. 13-4), or local forms provided for customer use. You should remove suggestions daily, after the evening meal, and turn them in to the FSO. The

SUGGESTION TO FOOD SERVICE OFFICER (4081)
NAVSUP FORM 1343 (REV. 11-78)

NOTICE TO DINING FACILITY PATRONS

The oriented dining facility strives to provide consistently high quality standards of service featuring popular, nutritious meals. Suggestions from patrons concerning improvements in food service are invited. You may submit your suggestions and ideas on the reverse of this form. For a reply to your constructive comment, please print your name and address below.



..... FOLD ON THIS LINE

SUPPLY OFFICER

POSTAGE AND FEES PAID
DEPARTMENT OF THE NAVY
DDO 74

OFFICIAL BUSINESS
PENALTY FOR PRIVATE USE \$300

TO [] *Name and address of Patron* []

..... FOLD ON THIS LINE

SN 0108-LF-561-2430

FRONT

TO: FOOD SERVICE OFFICER _____ (4200)

I suggest that consideration be given to:

..... FOLD ON THIS LINE

REPLY FROM FOOD SERVICE OFFICER

..... FOLD ON THIS LINE

Food Service Officer

U.S. GOVERNMENT PRINTING OFFICE: 1985 - 505-012/8533 2-1

REVERSE

Figure 13-4.—Suggestion to the Food Service Officer, NAVSUP Form 1343.

FSO should review all suggestions for possible adoption.

EVALUATING FOODSERVICE SUGGESTIONS.— Customers submitting suggestions or comments should be treated as individuals with individual needs. Most customers experience an empty stomach three times a day. Conversely, this need is routinely filled on a more impersonal basis—the same filling for all customers. You may provide the correct service, but if you treat the customer as just one of a group, rather than as an individual, it may cause resentment. Therefore, when evaluating suggestions or comments, you should present the right attitude toward the needs of the customer. These needs may run the extent from the ridiculous, through the routine, to the very difficult. However, these categories reflect your opinion of the needs and requests—not the customer's. The problems are important to the customers, otherwise they would not have submitted a suggestion or comment. Thus, you should make all customers feel that their problem is important.

Regardless of the nature or seriousness of a customer's problem, certain negative factors may serve to complicate it. For example, the customer may be angry, worried, or frustrated. Possibly, the customer may be unwilling to accept anything less than his or her desired solution to the problem. Awareness of these factors allows you to approach each suggestion practically and, in turn, deal with most rational suggestions effectively.

GIVING FEEDBACK ON SUGGESTIONS.— The FSO should evaluate all suggestions or comments and furnish a reply when requested, within 48 hours. The leading MS should make sure the proper action is taken to adopt or implement those suggestions the FSO considers favorable to improving the quality of service. Adopted suggestions should be posted twice weekly or placed in the ship or station plan of the day for the crew's convenience.

Recording Meals Consumed

There are different categories under which personnel fall when recording meal consumption. For you to account properly for all meals consumed in a GM, you must understand rations and ration entitlement. Also, the distinction between afloat and ashore recording procedures must be understood.

RATIONS.— Many times you have heard senior MSs say, "prepare 100 rations of that item." What the MS really meant is "prepare 100 portions" because a

ration is defined as a basic daily food allowance (BDFA). This and related terms will be explained next.

Basic daily food allowance. The BDFA is a prescribed quantity of food, defined by components or monetary value, required to provide a nutritionally adequate diet for one person for 1 day.

Supplemental food allowance. A supplemental food allowance is a prescribed quantity of food, defined by quantity or monetary value, which, due to unusual or extraordinary circumstances, is required in addition to the BDFA.

Special food allowance. A special food allowance is a prescribed quantity of food, defined by components, quantity, or monetary value, required when use of the BDFA is insufficient.

Night meals. Night meals are quantities of food that may be furnished to enlisted people standing night watches or performing other assigned duties between 2000 and 0800 hours. The value of food items used in preparing night meals is included in the total cost of issues to the GM. No additional ration credit may be claimed during sea periods regardless of the number of meals an individual consumes, including night meals.

Migrations (midrats). Midrats are food items such as soup, crackers, sandwiches, and leftovers normally offered to personnel assuming the midwatch and those being relieved. Midrats are different from night meals in that they are offered to personnel who have already consumed their breakfast, lunch, and dinner during normal meal hours. Therefore, they are not entitled to a full night's meal. The value of food items used to prepare midrats is included in the total cost of issues to the GM. However, taking ration credit for midrats and/or the sale of midrats is not authorized.

Combat meals. Combat meals are classified into special- and general-use categories. Special-use combat meals consist of individually packaged rations, long-range patrol (LRP) rations, and MRE rations. General-use combat meals are regular GM meals prepared from on-hand stocks of perishable and semiperishable subsistence.

Picnics, recreation events, and coffee messes. Personnel may be authorized by the CO to receive food items for picnics, recreation events, and coffee messes from the GM. COs should establish such controls as necessary to make sure only personnel entitled to rations-in-kind are furnished food without charge, cooked or uncooked, for picnics or coffee messes.

Rations-in-kind. This is the term used to describe meals furnished to enlisted personnel from the GM at government expense.

RATION ENTITLEMENT.— Regular and Reserve enlisted personnel of the armed services, officer candidates, cadets of the armed forces academies in a duty status, and prisoners of war are entitled to rations-in-kind at government expense under various appropriation acts.

Retired enlisted military personnel confined in a hospital or dispensary are entitled to rations-in-kind.

Destitute survivors of disasters, refugees, civilian evacuees, and American seamen may be fed without charge in Navy messes. Entitlement is determined and action taken to effect reimbursement by NAVFSSO as appropriate from the data furnished in the certification required for this category of personnel.

Rations are furnished to foreign government personnel on a cash basis, except when the invitational travel orders authorize other means of reimbursement. Enlisted personnel in a travel status who are receiving per diem instead of subsistence are not entitled to rations-in-kind unless their orders are endorsed showing the number and type of meals authorized.

Cash sales may be authorized to various types of personnel. Usually, approval of the CO is all that is required and, in some instances, this approval can be obtained in the form of supply department instructions. Only those personnel entitled to rations-in-kind are authorized to eat without charge; all others must pay for each meal consumed.

AFLOAT PROCEDURES.— On the first day of the month, the executive or personnel officer should advise the FSO of the estimated daily number of personnel entitled to be fed in the GM. The FSO should be told when any significant change to the number of personnel entitled to subsist occurs during the month. When rations for foreign or other personnel are included, the FSO should be informed also.

The FSO uses the daily expected number of rations allowed to accomplish the following:

- Post the General Mess Control Record, NAVSUP Form 338, each day at sea.
- Plan the quantities of food to be prepared on the following day based on the actual number of persons expected to be fed using the current acceptability factors.
- Prepare certifications as required and arrange to have them completed and signed before departure of

personnel requiring certification. The FSO signs certifications when signatures of persons in charge of groups cannot be obtained.

During days at sea, ration credit should be taken for each enlisted member on board. Ration credit also should be recorded daily on the NAVSUP Form 338 for all meals sold for cash. Days at sea includes the day of leaving and the day of arriving regardless of the time of departure or return.

During in-port periods, ration credit should be taken only for the personnel actually fed. Any convenient, accurate method for determining this number is permissible; usually, a hand counter is used by the master-at-arms as personnel pass through the serving line. Full ration credit may be taken in port while simulated at-sea exercises are being held and all personnel are remaining aboard overnight.

Ration allowances are adjusted to compensate for the change in the calendar day resulting from crossing the 180th meridian. When the time is set back 1 day in crossing from the west (Japan) to the east (United States), rations are credited for the extra day. When time is advanced 1 day in crossing from the east (United States) to the west (Japan), rations are not credited for the lost day.

ASHORE PROCEDURES.— To provide uniform and equitable procedures in accounting and estimating military feeding costs, the policy that such programs will be based upon actual food costs per person was established by the Assistant Secretary of Defense. Such costs are essential to the planning of budget requirements and for the development of absentee rates for congressional presentations. The development of per capita consumption costs is based upon the actual number of persons fed in Navy GMs ashore. This is accomplished by the signature head count method whereby a daily count is made of all personnel fed at each meal.

Activities with GMs physically located ashore include the following:

- All shore activities except naval hospitals operating hospital messes
- All mobile construction battalions and detachments eating in GMs ashore
- All fleet and force commands operating GMs
- All cargo-handling battalions eating in GMs
- All inactive service craft facilities

- All naval beach groups
- All GMs operated aboard permanently moored ships that grant liberty under shore command conditions, including naval inactive ship maintenance facilities

Daily Allowed Rations.— The executive or personnel officer verbally advises the FSO of any significant changes in the expected number of rations allowed for all categories of personnel to be fed in the GM for the following day. If warranted by local operating conditions, the executive or personnel officer furnishes this information more frequently. When the allowed rations include rations for foreign or other personnel for whom certification is required, the FSO is so advised. The FSO uses the daily expected number of rations allowed to accomplish the following:

- Plan the quantities of food to be prepared on the following day after adjusting the net allowed rations by other factors affecting the number of personnel to be fed.

- Prepare a certification of rations issued for personnel who require it. Before their departure, the number of rations received should be entered on the certificate and the person in charge of the group should sign it. If the signature of the person in charge of such personnel cannot be obtained, the FSO should sign the certificate.

Tenant activities should verbally advise the host command of any significant changes in the expected number of personnel to be fed in the GM for the following day.

Meal Pass.— The Meal Pass, NAVSUP Form 1105, is issued by the personnel office to identify each member authorized to eat in the GM ashore. The NAVSUP Form 1105 is available in white, blue, pink, green, salmon, and yellow.

The host command is responsible for coordinating procedures governing meal passes to ensure consistency by all tenant commands using the activity's GM. In this responsibility, the host command specifies the colors to be used for each category of personnel and prescribes procedures for controlling the issue of meal passes. Commands performing personnel and administrative functions must be responsible for the actual issue and control of NAVSUP Form 1105, which will be accepted as valid by any GM. Different color meal passes must be used to identify Naval Reserve and other military personnel in the following manner:

- Naval Reserve enlisted personnel on active duty should be assigned the same color meal passes as Regular Navy personnel and should, for the purpose of GM accounting, be considered Regular Navy.

- Naval Reserve enlisted personnel on active duty for training (ACDUTRA) should be assigned meal passes of a different color than Navy and Naval Reserve personnel on active duty and should be recorded and accounted for separately by the GM.

- Different color meal passes are assigned to enlisted members of other service categories as determined by local needs.

The possession of a meal pass entitles the holder to consume meals at government expense in any Navy GM; therefore, it is incumbent upon each command to make sure only those enlisted members entitled to receive such meals are issued and permitted to retain a NAVSUP Form 1105.

Commands issue a meal pass to each enlisted member assigned who is entitled to rations-in-kind. Meal passes are not to be issued to the following:

- Personnel receiving commute rations
- Personnel receiving basic allowance for subsistence
- Personnel assigned to another command, except at activities where two or more commands are serviced by a single personnel office

When a meal pass is issued to an individual, the individual's name and social security number are typed or printed opposite the pass number in the meal-pass log and the recipient signs the log.

Head Count Procedures.— A signature head count procedure is used by all shore GMs, except in cases of mass or captive feeding, to determine the actual number of personnel fed at each meal. Every person receiving a meal must sign, in ink, a Meal Signature Record, NAVSUP Form 1291, to indicate receipt (fig. 13-5). Ration credit is based on the number of signatures recorded. One initial surname and meal-pass number (except contract facilities' personnel who should insert one initial and surname only) are required of each individual. Command or unit entries are not required by parent (host) activity personnel or by tenant activity personnel if a means is used to identify individual tenant activities. Transient personnel are required to indicate their parent command or unit. Individuals passing through the serving line more than once during the same meal should sign the NAVSUP Form 1291 only once.

MEAL SIGNATURE RECORD (4051)
 NAVSUP FORM 1291 (REV. 2-72)

DATE 9-5-93 SHEET NO. 001

MESS LINE (1st, 2nd, etc.)

CATEGORY OF PERSONNEL (Check applicable block)	<input checked="" type="checkbox"/> NAVY REGULAR	<input type="checkbox"/> NAVY CADETS	<input type="checkbox"/> ARMY REGULAR	<input type="checkbox"/> COAST GUARD	<input type="checkbox"/> AIR FORCE NATIONAL GUARD
	<input type="checkbox"/> NAVY RESERVE	<input type="checkbox"/> MARCORPS REGULAR	<input type="checkbox"/> ARMY RESERVE	<input type="checkbox"/> CIVILIAN APPLICANTS	<input type="checkbox"/> FOREIGN
	<input type="checkbox"/> NAVY ROTC	<input type="checkbox"/> MARCORPS RESERVE	<input type="checkbox"/> ARMY NAT'L GUARD	<input type="checkbox"/> AIR FORCE REGULAR	<input type="checkbox"/> OTHER (Specify)

SIGNATURE (First initial and last name)	MEAL PASS NUMBER	COMMAND/UNIT	SIGNATURE (First initial and last name)	MEAL PASS NUMBER	COMMAND/UNIT
<i>R. Del Soria</i>	2321				
<i>W. Hamilton</i>	2079				
<i>D. Haughton</i>	6901				
<i>B. Howard</i>	2300				
<i>E. Leavitt</i>	2725				
<i>A. McPherson</i>	2327				
<i>C. Blazek</i>	2080				
<i>J. Thomas</i>	2257				
<i>D. Newton</i>	1955				
<i>C. Blasingame</i>	6902				
<i>A. Mercado</i>	5703				

U.S. GOVERNMENT PRINTING OFFICE: 1972-714-285/4358 2-1

Figure 13-5.-Meal Signature Record, NAVSUP Form 1291.

The FSO is responsible for conducting and monitoring the signature head count procedure. The FSO also must train personnel involved in controlling the signature head count procedure, placing special emphasis on the eligibility of patrons authorized to receive rations-in-kind at government expense.

The messdeck master-at-arms (MDMAA) is responsible for the following:

- Determining the eligibility of personnel passing through the serving line to eat in the GM
- Obtaining signatures and a legible meal-pass number on the NAVSUP Form 1291
- Preparing a daily Recapitulation of Meal Record, NAVSUP Form 1292 (fig. 13-6)

In discharging these responsibilities, the MDMAA places special emphasis on the eligibility of patrons authorized to receive rations-in-kind at government expense. The MDMAA performs the following:

- Requires each person to exhibit a valid meal pass and identification card

- Permits new arrivals on travel orders and receiving per diem to have the travel orders endorsed
- Receives the NAVSUP Forms 1292 for mass feeding in the GM and makes a manual count of the group as they enter the serving line to verify the total
- Enters Total Verified and signs on the second signature line of each NAVSUP Form 1292 for mass feeding within the mess area

The records keeper is responsible for verifying the entries made on the daily NAVSUP Form 1292 by the MDMAA and the cashier and for entry of meals served to personnel not passing through the serving line. The records keeper performs the following:

- Verifies totals of each type of personnel listed
- Checks cash sale to make sure credit sales are included in the count

RECAPITULATION OF MEAL RECORD (4061) PERIOD OF DATE
6 MAR 93

NAVSUP FORM 1292 (REV. 3-75)

CATEGORY OF PERSONNEL		BREAKFAST	LUNCH	DINNER	NIGHT/OTHER
NAVY	REGULAR				
	RESERVE				
	ROTC				
	CADETS				
MARINE CORPS	REGULAR				
	RESERVE				
ARMY	REGULAR				
	RESERVE				
	NATIONAL GUARD				
COAST GUARD					
CIVILIAN APPLICANTS					
AIR FORCE	REGULAR				
	NATIONAL GUARD				
FOREIGN					
OTHER (Specify)					
1ST SUBTOTAL			128		
CASH SALES (INCLUDE CONTRACT PERSONNEL)					
GRAND TOTAL					
CONVERSION FACTOR			20%		
RATION CREDIT					
"MASS FEEDING - SCHOOL"					
"TOTAL VERIFIED"					

Person in charge of the group will write an appropriate statement indicating the reason for mass feeding

The Master-at-Arms will count the personnel in the group to verify the first subtotal figure and write "Total Verified"

STATION AUDIT BOARD

The undersigned certify the above to be, for the period specified, an accurate recapitulation of enlisted dining facility meals received for

[Signature]
E.M. SCHOOLTIME, QMC, USN

[Signature]
E.M. MPA, AM2, USN

S/N 0108-LF-501-2920 U.S. Government Printing Office: 1982-688-000/24487 2-1

Figure 13-6.-Recapitulation of Meal Record, NAVSUP Form 1292.

- Makes sure the NAVSUP Form 1292 prepared for duty foodservice personnel is accurate and does not include personnel receiving commuted rations
- Checks meals requested and furnished against NAVSUP Forms 1292 for other types of personnel not passing through the serving line
- Makes sure the entry for contract foodservice personnel does not exceed the number on duty during the meal
- Reports noted inconsistencies to the FSO for corrective action
- Makes required corrections to personnel counts and coordinates the correction with the

responsible personnel for the error whereby both must initial the correction

NAVSUP Form 1291.— This form should be preserialized and the headings completed before each meal to ensure control and to prevent loss or misuse of the signature sheets. Either the MDMAA or the person authorized in writing by the FSO supervises the signing of the NAVSUP Forms 1291. The supervising MDMAA should be seated on a high stool behind the signature counter to verify meal passes and to direct personnel to the correct meal signature sheet. This assignment is one of the most important duties within the division. This person must be firm but fair in carrying out this assignment. This person must make sure each person passing through the serving mess line is entitled to either rations-in-kind or pays, without exceptions.

Categories of personnel. The number of personnel fed in each category is determined by requiring the personnel in each category (Regular Navy, Naval Reserve, Marine Corps, Army, Coast Guard) to sign separate forms. The forms should be placed on separate clipboards, color coded to match the meal passes, or have stenciled signs to indicate the personnel categories. Minor categories may be combined on a single form and the appropriate category entered in the Command/Unit column.

Night and brunch meals. Night meals are served between 2000 and 0800 hours. Brunch meals served before 0900 hours are recorded as breakfasts. Brunch meals served after 0900 hours are recorded as lunches.

Special feeding occasions. The number of persons fed at special feeding occasions, such as picnics, barbecues, and cookouts, are counted and reported for the regular GM meal that the special event replaces.

Mass or Captive Feeding.— Mass feeding means accounting for a group of personnel by using a NAVSUP Form 1292 as a summary document instead of obtaining individual signatures on a NAVSUP Form 1291. At activities with mass or captive feeding, such as recruit training centers, schools, brigs, and groups fed outside the GM, the person in charge of a draft or group of personnel uses a NAVSUP Form 1292 to record the number of personnel in each category to be fed at the meal. The person in charge computes the total; writes an appropriate statement in the Remarks block, such as “Mass feeding-school,” or “Mass feeding-picnic”; and signs on the first signature line including grade or rate and service number.

When a group is fed in the GM, the person in charge of the group presents the completed NAVSUP Form

1292 to the MDMAA upon entering the messdeck. The MDMAA makes a count of the group as it passes to verify the total, writes Total Verified, and signs on the second signature line. The MDMAA retains the NAVSUP Form 1292 and assembles it with the appropriate NAVSUP Forms 1291 for that meal.

Meals finished to personnel not passing through the mess line, such as working parties, inpatients of the dispensary or hospital, duty foodservice personnel, prisoners, and picnic or outing personnel, are handled as mass feeding. However, persons eating individually, in these cases, sign the NAVSUP Form 1291 and are excluded from the count on the mass feeding NAVSUP Form 1292. A person familiar with this responsibility is designated to prepare the NAVSUP Form 1292 and deliver it to the records keeper as soon as possible after the meal and no later than the following morning. The records keeper checks the form to make sure it is complete and makes such checks as possible to verify the total. The records keeper writes “Checked” and signs on the third signature line.

Meal Recapitulation.— Upon securing the mess line, the MDMAA assembles the forms in sequence by category and draws an ink line below the last name of each form. The MDMAA determines the total number of signatures for each category of personnel and enters the totals on a NAVSUP Form 1292, which is prepared in an original and one copy. The total of all categories is entered as the first subtotal. The totals for breakfast, lunch, and dinner are entered on the same form. Separate forms are not prepared for each meal. The MDMAA signs on the first signature line and delivers the NAVSUP Form 1292 to the FSO after the dinner meal. When more than one MDMAA is on duty at different meals, they both initial the subtotal(s) for which they are responsible and both sign on the first signature line.

Duty Cashier.— When cash sales are made, the duty cashier enters the total number of meals sold from the GM in the Cash Sales block, computes the second subtotal, and signs the certification on the second signature line. The entry opposite the Cash Sales block includes all meals sold, both those for which cash is collected before admission to the serving line and those sold on a credit basis. This figure should agree with the total recorded in the daily meal record.

On some stations the cashier billet may be combined with the MDMAA. This can be accomplished effectively providing the person assigned has received proper training. There is no individual duty or assignment that can be singled out as the most important within the foodservice division because it takes team

effort; however, the duties of cashier and MDMAA have the distinction of being the first customer contacts.

Letters of Authority, Authorization, and Appointment

Letters of authority appoint personnel to act for another person or persons of higher authority. Letters of authorization permit certain functions or actions. Letters of appointment assign responsibility and authority to designated personnel to control a specific function. The supply officer must maintain, in the supply office, a current file of all such letters applicable to operating the supply department. Copies applicable to the GM should be retained by the FSO.

LETTERS OF AUTHORITY.- The following are letters of authority that may be required in the foodservice division:

- CO's letter appointing an assistant to the supply officer as the FSO
- CO's letter appointing the person authorized to receipt for food items in the absence of the FSO and his or her designated assistant
- Mess treasurer's letter designating a person to approve issue requests for a private mess

LETTERS OF AUTHORIZATION.- The following are letters of authorization that may be required in the foodservice division:

- CO's letter authorizing the FSO to make necessary changes in the approved menu
- CO's letter authorizing the sale of meals from the GM on a credit basis
- CO's letter authorizing a change fund for the GM

LETTERS OF APPOINTMENT.- The following are letters of appointment that may be required in the foodservice division:

- CO's letter appointing a control officer for the handling and security of the Cash Meal Payment Book, DD Form 1544
- FSO's letter appointing an individual to be a collection agent or authorized funds custodian
- FSO's letter designating a cashier to receive payment for meals sold from the GM

INVENTORY CONTROL AND PHYSICAL SECURITY

We have already concluded in previous chapters the importance of maintaining a balanced load to support the ship's mission. In this regard, procedures should be set in motion to control your inventory levels. This includes employing safeguards for the security of your inventory.

These procedures should contain provisions for reviewing the accuracy of inventories, actual issues, and records. You should review these items as necessary to ensure the continued availability of balanced stocks.

The actual (physical) inventory of food items on board should be accurately reflected in the inventory records. Improperly kept records support practices that, without exception, will lead to inefficiency and cause losses in money and material.

Stock Maintenance

In chapter 12, we discussed how to determine the extent and types of stocks to maintain on board. The topics discussed next are critical in the efficient maintenance of required stock levels.

- You should constantly check your food inventory to ensure rotation and use of stocks to prevent oversupply, which may result in surveys. Store stocks so the oldest stocks can be used first.

- Review past usage records regularly. They will help achieve balanced requisitioning by showing what is on hand and what items are needed.

- Make sure menu changes are kept to a minimum. An accumulation of menu changes can unfavorably affect your balanced load, either increasing or decreasing the planned usage of food items. This results either in stocks being depleted faster than expected or unused stocks unnecessarily taking up storage space.

- Adjust your high and low limits as necessary to adapt to an increase or decrease in crew size. This helps make sure you order an accurate quantity of food items for a loadout.

- Regularly review food stocks currently on hand during underway periods. If inventories point out stocks that are in either long or short supply, temporary adjustments to the cycle menu can be made to balance stocks.

ISSUE CONTROLS AND PROCEDURES.-

Repeated use of your menus and breakout guides allows you to adjust breakout requirements to match the quantities actually needed for preparation of the meals by yielding breakout information that closely reflects actual requirements.

When you review a document requesting an issue, you should make sure it reflects only the items actually needed and in the correct quantities.

Authorization.- Documents requesting breakouts to the galley must be approved by the FSO or a person designated in writing by the FSO. The FSO establishes controls to account for each issue document. Issue documents are prepared in triplicate and approved by the senior MS on duty. The original should be forwarded to the FSO on the morning following the date of issue.

Documentation.- Issues to the GM must be made either on a NAVSUP Form 1282 or a NAVSUP Form 1059, each prepared in triplicate. Issue procedures were discussed in detail in chapter 2.

RETURN OF UNUSED ISSUES TO STOCK ON HAND.- Return all unused and unprepared food items remaining in the galley after completion of meal periods to the issue storeroom at the end of each day. The NAVSUP Form 1282 containing the daily issues should be changed to document items and quantities returned and reflect any quantities issued to the galley. The NAVSUP Form 1282 should be signed by both the senior MS on duty and the issue-storeroom custodian.

FREQUENT SPOT INVENTORIES.- Frequent (twice weekly recommended) counting of fast-moving and high-cost items is advisable to maintain financial control of GM accountability. When spot inventories are conducted, all affected records should be adjusted.

Key Custody and Controls

Afloat Supply Procedures, NAVSUP P-485, and *Food Service Management*, NAVSUP P-486, describe current security information.

The basic rules set down by the NAVSUP P-485 for key security are as follows:

- Supply spaces must be kept locked when not in use.
- Custody and responsibility for any space must rest with the person in charge of that space.

- Permission for entry of persons not ordinarily authorized to have access must be obtained from the supply officer, FSO, or a delegated representative.

- No space should be secured in such a manner that access by use of ordinary damage control equipment is hindered in an emergency.

- Keys to supply space padlocks must not be taken from the ship and should be turned in to the key locker when the custodian goes ashore. Keys to GM working spaces may be passed between watch captains and not locked in the key locker.

- Whenever an original or duplicate key is lost, a new lock must be placed in use.

- Combinations to locks must not be recorded in writing except for a written combination in a sealed opaque envelope. This envelope must be signed over the flap by both the custodian and the accountable officer in the presence of one another and retained in the accountable officer's safe.

- All key padlocks must be of 1 1/2-inch size.

- All keyless padlocks used must be of the three-combination, manipulation-resistant type.

Aboard submarines, because of unique space limitations, damage control purposes, and the necessity for storing material in widely separated small spaces, it is not feasible to keep all supply spaces locked. Fleet, type, and local instructions make necessary provisions for appropriate deviations.

Train your personnel to lock the padlock on the staple and remove the key whenever they enter a storeroom or other locked supply department space. This procedure prevents keys from being locked in the storeroom and locks from being lost or switched by unauthorized personnel. It also prevents members from being locked in the space by a passerby who may think the space has been left unlocked by oversight.

LOCK GROUPINGS AFLOAT.- Aboard ship, the locks of the foodservice division are integrated with those of the rest of the supply department. Locks and keys for individual spaces are grouped by the following functional areas:

- Group I spaces consist of all supply department and general stores spaces, including storerooms, special lockers, and related spaces.

- Group II spaces consist of foodservice spaces including the galley, bake shop, bread room, vegetable

preparation area, foodservice issue room, meat preparation area, refrigerated spaces, and foodservice storerooms.

- Group III spaces consist of the ship's retail and clothing stores, the fountain, vending machines, and related bulk storerooms.

- Group IV spaces consist of the ship's service activities such as the barbershop, tailor shop, dry-cleaning shop, and laundry.

For all afloat groups, each lock must be opened by an original and duplicate key different from the keys to any other space. Additionally, each group must have a master and one duplicate master key capable of opening every lock in the group. here also must be a grand master and one duplicate grand master capable of opening every lock in every group. **NOTE:** Group III has special keyless padlocks that are excepted.

Afloat, accountable food items must always be kept under lock and key. The only exception is when the bulk of such material needed for a required endurance load makes storage under lock and key impractical. Storage of accountable food outside of locked and controlled storerooms should not be done without the knowledge and consent of the supply officer. Physical inability to store all items under lock and key may mitigate, but does not relieve the FSO or his or her responsibility for accountability.

LOCKS ASHORE.— At ashore GMs, the locks of the foodservice division may or may not be integrated with other locks of the supply department. In either case, the FSO must be knowledgeable of the existence and have control over any master and duplicate master keys that can open foodservice spaces.

The following procedures further outline custody and handling of keys:

- No two spaces should have locks that can be opened with the same original and duplicate key except master and grand-master keys.

- The person in charge of the space must get the original key from the general key locker at the beginning of the day. This person must keep possession of the original key during working hours and return it to the general key locker after working hours.

- The general key locker should be located in the supply office to provide centralized key control.

- Duplicate keys should be kept in a duplicate key locker in the supply office or in the supply officer's safe.

The supply officer may authorize a special duplicate key locker when procedures require recurring use of duplicate keys.

- When these procedures do not satisfy local circumstances, the supply officer may prescribe in writing alternate procedures to ensure proper control of keys and access to spaces.

- Equipment and locker keys to cabinets and small nonaccountable gear storage lockers located in the common messing area are controlled as directed by the FSO.

As department head, the supply officer has overall accountability and right of access to all foodservice spaces. This right of access does not compromise accountability.

AUDITING ACCOUNTING RECORDS

As was stated in chapter 3, the objective of any system of records maintained by a messing facility is to provide a source of data to be used in the preparation of the required financial statements for that messing facility. When properly maintained, these records also provide information that allows a more efficient operation of the messing facility. To this end it is vital that an auditing process be in place that allows for frequent checks of all records to ensure their accuracy.

Balancing the Subsistence Ledger

The records keeper maintains the Subsistence Ledger, NAVSUP Form 335, keeping one for each food item on board. This form provides a record by quantity of receipts and expenditures. It also provides a running balance on hand for each food item. Such transactions occur regularly and should be recorded to reflect the actual date of each transaction. The types of transactions are receipts, issues, sales, transfers, surveys, or inventory adjustments resulting from inaccurate inventory. Each transaction must be recorded accurately.

To make sure all transactions are recorded accurately and the math is correct, the FSO or designated representative must periodically perform certain checks. He or she should check to make sure the correct unit is used for all transactions recorded.

Unlike other stock items, food items have two unit prices—the fixed price and the last receipt price. The purchase price for food items on the commercial market fluctuates and the GM must operate on a fixed ration

allowance. For this reason, NAVFSSO establishes a fixed price for all items used in the GM. Thus, the same charge is made for an item throughout the accounting period regardless of the current market or receipt price. The receipt price for each receipt should be entered in the space provided along with the date of receipt. This price is used to survey, transfer, or sell items to private messes and to extend inventory value.

You can verify the current on-hand balance by adding all receipts to the opening inventory and subtracting all issues, transfers, surveys, and sales. The resulting figure should equal the current on-hand balance.

You can confirm the Cumulative Total (issues) figure by running a printout or tape. Add the beginning inventory and all receipts. Subtract all quantities in the Other column and subtract the current on-hand balance. The result will equal the Cumulative Total figure if there are no mathematical errors on the NAVSUP Form 335.

The Subsistence Ledger, NAVSUP Form 335, is considered a paper inventory and should not be interpreted as a true representation of the physical inventory. An actual physical inventory should be conducted to confirm the paper inventory. As was discussed earlier, frequent spot inventories should be conducted on fast-moving and high-cost items.

Cash Collection

The FSO is responsible for collecting required basic charges and surcharges received from the sale of meals from the GM. Additionally, he or she is responsible for depositing such funds with the disbursing officer. When wardroom members are furnished meals from the GM, whether continually or during in-port periods, the mess treasurer is responsible for the collection and reimbursement for such meals.

RECEIPT AND RECORDING OF FUNDS.-

The FSO designates, in writing, cashiers to receive payment for all meals sold for cash. Payment may either be received in advance through sales of meal tickets or directly from personnel as they enter the GM.

DOCUMENTATION.- Various forms are used to document sales of meals. Those used to classify ration entitlement and to document rations-in-kind were discussed earlier in the chapter. Discussed now are the forms used to record receipt of funds.

Cash Meal Payment Book.- The Cash Meal Payment Book, DD Form 1544, is used to record meals sold for cash from a GM in the manner prescribed next.

The CO will designate a control officer for the handling and security of the DD Form 1544. The transfer control and receipt coupons (four numbered coupons per book) will be used to complete the book. Individuals authorized to receive cash meal payment books sign the transfer control and receipt no. 1 at the time of receipt. The coupon is then retained by the control officer transferring the book. Another transfer control and receipt coupon is used to return the completed book.

Cash Meal Payment Sheet Register.- The headings Organizations and Installation are filled in by the appointed control officer. The individual (normally a cashier) authorized to receive cash meal payment sheets should sign and insert the organization and date on the cash meal payment sheet register. He or she must make sure the sheet numbers correspond on both the payment sheets (described in the next paragraph) and the register. When the cash meal payment sheets are completed they are returned to the control officer. Now, the columns Date Returned, Cash Collected (foods surcharges), and Received By should be filled in. The Voucher No. column should not be completed since this column may be used at some future date.

Cash Meal Payment Sheet.- Before using this form, the Organization block is completed. It also should have all applicable charges such as food charges, surcharges, or per diem as prescribed in the NAVSUPINST 4061.9.

The cashier makes sure all individuals paying cash for meals sign their names and indicate their grade. He or she should then insert the applicable charge after each signature.

A cash meal payment sheet also may be used for periods exceeding 1 day. In this case, the cashier should fill in the first unused line with his or her signature, rate, and date. Below this signature, rate, and date, a double line should be drawn to separate dates.

After a payment sheet has been completed and all totals inserted, the cashier signs and inserts his or her rate and the date. The cashier then turns the sheet in to the control officer or appointed representative.

When cash is turned in to a collection agent or disbursing officer, the DD Form 1544 serial and sheet numbers are entered next to the signature of the individual turning in the cash in the Cash Receipt Book, NAVSUP Form 470. The DD Form 1544 and the Sale of General Mess Meals, NAVSUP Form 1046 (credit sales), are used to substantiate sales from the GM and the ration credit claimed.

The DD Form 1544 is audited and reconciled at the time the cash is collected by the collection agent or authorized custodian appointed to that established position by the FSO. The FSO should review the DD Form 1544 at least weekly and make sure an audit is made when the cash is collected.

Funds held by the cashier more than the allowed change fund should be collected daily. The only exception to this is cash received from meals sold on weekends or holidays. This cash may be retained in the personal custody of the cashier provided adequate facilities exist for the security of such funds. Separate and adequate facilities should be either a secured safe with a three-tumbler combination lock or a locked container within a safe of this type. At the close of each meal period cashiers are personally responsible for the security of all funds in their possession. Cashiers remain responsible for such funds until depositing them with the authorized collection agent.

The FSO appoints collection agents and authorized custodians. GM cashiers and the FSO cannot be designated as collection agents. Each individual responsible for funds must be provided with his or her own safe or a separate locked compartment in a larger safe.

Overages and Shortages.— The cashier records overages and shortages in cash received from the sale of GM meals on the DD Form 1544. During the daily audit, the collection agent verifies the difference during the weekly DD Form 1544 inspection. The agent determines the cause of cumulative cash differences in excess of \$1 or .05 percent (whichever is larger) per cashier for the week. The collection agent then acts as warranted by the circumstances to prevent a recurrence.

Any cash discrepancy involving possible fraud or criminal act, regardless of value, should be recorded as outlined in the *Navy Comptroller Manual*. Total overages and shortages exceeding 10 dollars should be reported as part of line 5 on the NAVSUP Form 1357. This line is for undeposited sales that exist at the end of the month or patrol cycle. A letter should be prepared and submitted with the NAVSUP Form 1357 explaining the circumstances involved with the gain or loss. This letter also serves to request authority to reduce accountability by deposits (gains) or expenditures (losses) reported on line 5.

Credit Sales.— If the sale of meals from the GM has been authorized and is considered quite practical, the CO may authorize the sale of meals on a credit basis.

This authorization is for officers, enlisted, and other categories subsisting daily.

When meals are sold on a credit basis, the Sale of General Mess Meals, NAVSUP Form 1046 (fig. 13-7), is used to record these credit sales in the following manner:

<u>Captions</u>	<u>Explanations</u>
Name	The full name, grade or rate, and branch of service of the person receiving the meal should be filled in by the FSO.
Meal	B - breakfast L - lunch D - dinner
Month and Year	The individual receiving the meal initials in the appropriate block opposite his or her name to acknowledge receipt of the meal except for full days at sea when members are charged for three meals. (See fig. 13-7.)
Total Sales Rate Values Total Value	The FSO should complete these blocks at the time payment is received. The FSO should acknowledge receipt of payment on the date payment was received.
Certification Total Cash Collected Date	At the end of the month and upon detachment, the FSO should complete this portion of the form.

When the CO determines that it is impractical and uneconomical to subsist a small number of officers in the established wardroom during in-port periods, weekends, and holidays, he or she may authorize officers to purchase meals from the GM.

At the option of the CO, a GM MS may be assigned the duty of maintaining the NAVSUP Form 1046. The MS should place a check mark or maintain a running total in the appropriate block opposite each name to show consumption of a meal. The form should be posted in a noticeable location where it can be seen by the wardroom mess members. At the end of each month, each mess member signs in the Name block to acknowledge approval of the meal tally.

The payment for all meals sold on a credit basis is required no later than 15 days following the month in

SALE OF ENLISTED DINING FACILITY MEALS

NAME	MEAL	MONTH: JANUARY YEAR: 1993																															TOTAL SALES			RATE	VALUES	TOTAL VALUE
		1	2	3	4	5	6	7	8	9	10	11	12	13	14	15	16	17	18	19	20	21	22	23	24	25	26	27	28	29	30	31	B	L	D			
ERIC T. HOLMES LT, USN <i>Eric T. Holmes</i>	B							X	X	X																X	X		X	X	18			95	17.10	76.00		
	L							X	X	X																X			X	X	17			190	32.30			
	D								X	X															X	X						14			190		26.60	
TOM B. REMELY LT, USN <i>Tom B. Remely</i>	B						X								X	X	X									X			X		17			95	16.15	84.55		
	L						X								X	X									X	X		X	X	23			190	43.70				
	D								X											X						X					13			190	24.70			
DOUG R. FRIESEMAN LT, USN <i>Doug R. Friese</i>	B						X	X	X						X											X					15			95	14.25	80.75		
	L						X		X	X					X	X									X	X				18			190	34.20				
	D							X	X						X						X	X	X								17			190	32.30			
SEAN K. O'KEEFE LTJG, USN <i>Sean K. O'Keefe</i>	B						X								X	X										X					16			95	15.20	74.10		
	L						X		X						X	X									X			X		18			190	34.20				
	D							X							X										X						13			190	24.70			
MIKE A. WORLEY LTJG, USN <i>Mike A. Worley</i>	B	AT SEA	AT SEA	AT SEA	AT SEA	AT SEA	X	X	X	X					X										X	X				17			95	16.15	73.15			
	L	AT SEA	AT SEA	AT SEA	AT SEA	AT SEA	X	X	X	X					X	X								X	X				17			190	32.30					
	D	AT SEA	AT SEA	AT SEA	AT SEA	AT SEA	X	X							X									X						13			190	24.70				
WILLIAM B. ELLIS ENS, SC, USN <i>W.B. Ellis</i>	B	AT SEA	AT SEA	AT SEA	AT SEA	AT SEA	X	X						X											X	X				13			95	12.35	65.55			
	L	AT SEA	AT SEA	AT SEA	AT SEA	AT SEA	X	X	X					X										X	X				16			190	30.40					
	D	AT SEA	AT SEA	AT SEA	AT SEA	AT SEA	X							X										X						12			190	22.80				
BILL C. LANSFORD ENS, USN <i>Bill C. Lansford</i>	B						X								X										X	X				15			95	14.25	86.45			
	L						X	X	X						X	X									X	X	X		X	23			190	43.70				
	D							X							X										X	X	X			15			190	28.50				
CASH SALES	B																													111			95	105.45	540.55			
	L																													132			190	250.80				
	D																													97			190	184.30				
TOTALS										32	258	58	215	193	113.8	540.55																						

Figure 13-7.-Explanation of the Sale of General Mess Meals, NAVSUP Form 1046.

which the meals were sold. Individuals concerned should make payment before detachment. The FSO furnishes a receipt for the cash paid. The Cash Receipt Certificate, NAVCOMPT Form 2114, maybe used as a receipt form. This is done by marking out the line "for which I hold myself accountable to the Treasurer of the United States of America."

Deposit of Funds.- When practical, finds in excess of the change fund should be deposited daily with the disbursing officer. When impractical to make daily deposits, the cash should be deposited at least twice weekly. Any exceptions to this must be authorized by the Naval Supply Systems Command. When it is impractical for the collection agent to deposit cash daily, it should be retained in the collection agent's personal custody or turned in to the FSO.

Accountability File

The FSO must maintain files of accounting records and substantiating documents required for audit of subsistence, supply, and GM operations. Records and documents must be retained and disposed of according to *Navy and Marine Corps Records Disposition*

Manual, SECNAVINST 5212.5. See also appendix B of the NAVSUP P-486, volume 1.

RESPONSIBILITY.- The accountability file must be established by the FSO on the first day of the accounting period.

SECURITY.- The accountability file must be kept under lock and key by the accountable officer to maintain security of all accountable transactions and substantiating accountable documents.

At the end of the quarter, the documents in this file become the ship's retained returns for the period, except the rough inventory. The rough inventory should be retained in the accountability file until the next rough inventory is made.

SANITATION

Sanitation was discussed in detail in chapter 1. This chapter addresses sanitation from the management position.

The FSO is held directly responsible for any foodborne illness that may result from improper or

careless preparation, serving, or storage of food. Consequently, he or she must ensure the following accomplishments:

- Frequent inspections of equipment and personnel are conducted.
- Formal and informal training is carried out as dictated.
- All foodservice personnel receive physical examinations as prescribed in SECNAVINST 4061.1 and NAVMEDP-5010-1.

As the most senior MS, you will be directly responsible to the FSO for the maintenance and sanitary conditions of all foodservice spaces, equipment, and utensils.

In this position, you must prescribe and enforce the rules and regulations regarding the general cleanliness and sanitation of equipment, utensils, and working uniforms of foodservice personnel. Additionally, you are responsible for the proper storage of food equipment and for the use of sanitary procedures in the preparation and service of food.

Frequency of Inspections

To make sure all foodservice section rules and directed procedures are being followed, the FSO and the senior MS should make both routine daily inspections and thorough weekly inspections of all foodservice personnel, spaces, and operations.

Training

Foodservice personnel play an important role in the prevention of foodborne illness by adhering to good personal hygiene procedures. For foodservice personnel to understand these practices and procedures and appreciate their importance in preventing foodborne illness, they must receive formal training as prescribed in SECNAVINST 4061.1 in addition to their regular, supervised on-the-job instruction. Chapter 1 discusses the types, degrees, and frequencies of all required training necessary for all foodservice personnel.

Physical Examinations

Physical examinations are a means of medically screening personnel for evidence of communicable disease before initial assignment in foodservice. They are conducted to, at a minimum, detect evidence of diseases that may be transmitted by food. To this end,

you must make sure all personnel receive an initial physical examination before they are assigned foodservice duties. The specific regulations governing physical examinations are discussed in chapter 1. Additional guidance can be found in chapter 1 of the NAVMED P-5010.

Monitoring Temperatures

Foodservice personnel must exercise special and continuous close surveillance over all food items, foodservice spaces, and foodservice equipment to make sure prescribed temperatures are constantly maintained. You must make sure this action is taken to prevent the following conditions:

- Damage to food items
- Heat stress conditions in food preparation spaces
- Improper preparation of food
- Inadequate holding temperatures for prepared food items
- Inadequate temperatures in the dishwashing and sanitizing process

Consequently, you must develop and carry out a system for monitoring the temperatures of these items.

FOOD ITEMS.— You should supervise the length of time that foods are held at room temperatures during handling and preparation. This will aid in making sure contamination does not occur. Hand preparation not only increases the likelihood of contamination but increases the time foods are at room temperature. The following are some objectives you want to accomplish when regulating temperatures of food items from the time the food is broken out until it is consumed or discarded:

- Make sure food is always refrigerated except during actual preparation or serving.
- Keep time between preparation and consumption to a minimum.
- Keep frozen foods frozen until removal for preparation.
- Thaw food at temperatures between 36°F and 38°F.
- Never thaw food by exposure to heat or in water.
- Once thawed, never refrigerate food.

- Food items that will not be served immediately should be handled in the following manner:

Place in shallow pans (food depth not more than 3 inches) and cover

Label the product with the time and date of preparation, name of product and person storing product, and expiration date of product

Then immediately refrigerate at temperatures below 40°F

Leftovers should be avoided if possible. However, if unavoidable, they should be handled in the manner just described.

NOTE: Do not hold any hand-prepared item as a leftover.

FOOD PREPARATION AREAS.– Food preparation areas must be monitored to ensure proper ventilation. Proper ventilation allows for a net flow of air into the spaces reducing excessive temperatures that may cause heat stress. Temperatures in foodservice spaces should not exceed 78°F. For additional information on heat stress monitoring, see chapter 3 of the NAVMED P-5010.

STORAGE SPACES.– Storage spaces must be monitored to prevent the deterioration of perishable food items resulting from improper temperatures.

The following are causes of deterioration of perishable food items:

- Bacteria, yeasts, and molds. They are the primary causes of spoilage. Usually an objectional odor indicates spoilage by bacteria. Yeast induces spoilage for items of high sugar content, particularly if stored between 77°F and 90°F. Mold can be detected by visible threadlike filaments growing on the surface of food items.

- Age. All foodstuffs will spoil if kept in storage too long. This type of spoilage is prevented by issuing the oldest items first.

Storerooms for semiperishable items should be clean, cool, dry, lighted, and well ventilated.

You must maintain temperature logs for all refrigerated spaces. Temperatures of bulk refrigerated spaces must be taken from thermometers inside each space at least twice daily. These temperatures are recorded in a log and maintained by the jack-of-the-dust. The engineering department must maintain a separate log with temperatures taken from remote sensors. Temperature problems should be immediately reported to the FSO.

It is important that fresh and frozen food items should be stored in three separate food categories. The following are the categories and associated requirements for proper temperature maintenance:

- Fresh fruit and vegetables. Air circulation is important—containers should be raised off the deck. This is accomplished by using pallets. The use of a fan helps maintain air circulation in all parts of the room. Proper temperatures must be maintained at 32°F to 35°F. Humidity should be from 85 to 95 percent.

- Dairy products and eggs. Air circulation may be accomplished for these items by storing on pallets that are raised off the deck. Additionally, there should be a fan capable of keeping the air circulating. Proper temperatures must be maintained at 32°F to 34°F.

- Meat and other frozen products should not be stored on bare decks. The use of pallets to raise items off the deck permits air to circulate under the items. Temperatures for frozen products must be maintained at 0°F or below.

Acceptable temperature ranges for chilled and frozen storage or holding spaces are as follows:

- Dairy: 32°F to 34°F
- Reach-in refrigerators: 34°F to 44°F
- Chill and vegetables: 33°F to 36°F
- Thaw box: 36°F to 38°F
- Freezers: 0°F or below

There should be no frost buildup on the chill or freeze box coils. The chill and freeze boxes should be defrosted and cleaned regularly. This is best accomplished when provisions are low and just before loading out.

The engineering department should be informed when a major onload of stores is going to take place. This allows them to plan ahead and secure the boxes affected. This will prevent high or unnecessary loads on the chill or freeze unit and frost buildup during the loading evolution. Hot gassing operations to defrost may even be planned during this time. Remember to start the reefer units up immediately after the onload and have a qualified person standing by to monitor the first couple hours of reefer operation.

EQUIPMENT.– Equipment such as ovens, griddles, fryers, and dishwashing and sanitizing equipment should be calibrated periodically. This is

done to make sure they can maintain the required temperatures for their respective purposes.

Before calibrating ovens, griddles, fryers, and dishwashing and sanitizing equipment, you should always consult the manufacturer's technical manual before making any adjustment. These procedures are written as general guidelines.

There are three types of thermostatic controls. The two that will not be discussed at length here are those that have a backing plate with the temperatures marked or etched on it and those with a movable toothed sleeve on the back of the knob.

The most common type of thermostat has a removable knob that exposes a hollow shaft with a screw inside. When you turn the screw clockwise on this thermostat, the temperature is lowered. When you turn the screw counterclockwise, it raises the temperature.

A pyrometer with a surface probe is used to calibrate griddles. A wire probe is used for ovens and a needle probe is used for deep-fat fryers, steam lines, sculleries, and so on. Use of pyrometers is explained in the Standard Preventive Maintenance Subsystem Identification Guide (SPMIG).

Dishwashing and sanitizing equipment must be constantly inspected and periodically calibrated. This must be done to make sure the equipment is capable of maintaining the required temperatures for all stages of the dishwashing and sanitizing operation. Dishwashing and sanitizing are the most important steps in breaking the chain of infection. If dishes are not clean and sanitary, germs can grow and reproduce. No matter what method you use—by hand or the preferred machine method—the final results depend upon the operator.

Proper machine washing temperatures are as follows:

- Wash: 150°F to 160°F
- Rinse: 160°F to 180°F
- Sanitize/final rinse: 180°F to 195°F

Manual dishwashing temperatures are as follows:

- Wash: 95°F to 125°F
- Rinse: 120°F to 140°F (do not put hands in this water, use a dip basket)
- Sanitizing rinse: 170°F with a 33-second contact time (do not put hands in this water, use a dip basket)

Allow all items to air dry and store clean dishware and equipment inverted.

Routine operational tests should be conducted to make sure the correct temperatures are maintained for both manual and mechanical dishwashing.

PREVENTIVE MAINTENANCE

It is a fact that a well-maintained galley plays an important role in effective foodservice. This further contributes to labor saving and high morale. Yet, there are no Navy schools that provide training on the proper upkeep of galley equipment. Contrary to this is the fact that galley equipment is often the most used and abused equipment found aboard ships. Engineers may often be preoccupied with other matters such as refresher training (REFTRA) or operational reactor safeguards examinations (ORSEs). For this reason, the role of the senior MS is vital. He or she must conduct frequent equipment inspections as well as monitor required maintenance to make sure it is done properly. If frequent inspections are not conducted to determine needed repairs, equipment deficiencies may go unnoticed and lead to decreased operating efficiency and safety hazards to personnel.

The Navy's planned maintenance system (PMS) maintenance actions are the minimum required to maintain Navy machinery and equipment in a fully operable condition within given specifications. To this end, preventive maintenance is set up for all equipment that may be seriously damaged or affect the safety of the operator if it should break down. The Navy PMS program provides a list of all equipment that requires periodic inspection, adjustment, cleaning, and lubrication.

The senior MS is directly responsible to the FSO for the proper maintenance of all spaces and equipment of the foodservice section. In this position, you must advise the appropriate department or division of all required repairs to foodservice equipment and spaces.

A Machinist's Mate should take care of the oiling of your equipment. However, it is up to you to make sure it is done as scheduled.

Preventive Maintenance Schedules

Proper use of the PMS program ensures maintenance is conducted and completed when required. It provides a simple and standard means for planning, scheduling, controlling, and performing

preventive maintenance. The PMS program uses schedules and documents, some of which areas follows:

- A weekly PMS schedule shows the planned maintenance schedule for accomplishment during a specific week.
- A quarterly PMS schedule shows the planned maintenance schedule for accomplishment during a specific 3-month period.
- A cycle PMS schedule shows the planned maintenance requirements to be performed during the period between major overhauls of a ship.

Routine Maintenance

Each piece of galley equipment has a maintenance requirement card (MRC). This card provides detailed procedures for performing maintenance requirements and tells, who, what, when, how, and with what resources a specific requirement is to be accomplished. It also states safety precautions that reduce the chance of costly or dangerous preventive maintenance errors.

PMS Audit/Spot Check

Individual maintenance requirements are audited to determine the effectiveness of PMS accomplishments. The FSO or other designated person performs a PMS audit on at least one maintenance requirement (MR) per week. The following steps should be taken when conducting a PMS audit:

1. Randomly select from a weekly or quarterly schedule a maintenance requirement that has been crossed off as being completed.
2. Identify and call upon the individual who performed the maintenance requirement.
3. Have this individual pull the MRC (auditor should read the MRC and become familiar with the steps performed). Proceed with the individual to the equipment selected to be checked.
4. Then question the maintenance person. The questioning should be of a general nature and related to the maintenance requirement.

Memorizing the card is not required, but if the maintenance was done, the person should be familiar with the MRC. Inquiries should be made to determine the following information:

- If the person actually did the work. (If not, a scheduling or supervisory problem exists.) If the person did not do the work then the individual who actually did the maintenance should be questioned.
- If all basic parts of the maintenance requirement were done; for example, if parts of the MR required operation of the equipment were they in fact operated.
- If basic safety precautions were observed.
- If the proper tools and materials were used.
- If disassembly was part of the procedure, inspect the equipment for evidence of disassembly, such as mechanical guards or hold-down bolts.

Finally, the work center supervisor should be asked the technical accuracy of the MRC.

Self-Help

Organizational self-help is defined as a unit's personnel working in its own workspaces performing handyman and general maintenance and repair projects.

COs may use self-help to perform projects that reduce critical maintenance backlog identified in the annual inspection summary (AIS).

An organizational self-help program should be established within your foodservice operation for the purpose of improvement through optimal use of available resources. Command support in providing funding, manpower, and material is vital.

Setting up a self-help program within the foodservice division should provide improvement through the best use of available resources. Your command must support such a program for it to be successful. This support should be in the form of providing funding, manpower, and material.

Leading MSs may use self-help to perform projects that reduce critical maintenance overload as well as improve the effectiveness of the foodservice operation. This further enhances morale and cost control.

APPENDIX I

REFERENCES

NOTE: Although the following references were current when this TRAMAN was written, their continued currency cannot be reassured. Therefore, you need to be sure you are studying the latest revision.

Chapter 1

Food Service Management, NAVSUP P-486, Department of the Navy, Naval Supply Systems Command, Washington, DC, April 1993.

Foodservice Operations, NAVSUP P-421, Department of the Navy, Naval Supply Systems Command, Washington, DC, November 1990.

Manual of Naval Preventive Medicine, NAVMED P-5010-1, Department of the Navy, Bureau of Medicine and Surgery, Washington, DC, June 1991.

Chapter 2

Federal Supply Catalog, Group 89, Subsistence, Department of the Navy, Naval Supply Systems Command, Washington, DC, October 1989.

Food Service Management, NAVSUP P-486, Department of the Navy, Naval Supply Systems Command, Washington, DC, April 1993.

Foodservice Operations, NAVSUP P-421, Department of the Navy, Naval Supply Systems Command, Washington, DC, November 1990.

Manual of Naval Preventive Medicine, NAVMED P-5010-1, Department of the Navy, Bureau of Medicine and Surgery, Washington, DC, June 1991.

Veterinary Food Inspection Specialist, FM 8-30, Headquarters, Department of the Army, Washington, DC, August 1986.

Chapter 3

Food Service Management, NAVSUP P-486, Department of the Navy, Naval Supply Systems Command, Washington, DC, April 1993.

Chapter 4

Naval Ships' Technical Manual, chapter 9340, Department of the Navy, Naval Sea Systems Command, Washington, DC, August 1967.

Food Service Equipment, Military Handbook, MIL-HDBK-1119, Department of Defense, Commander, Naval Facilities Engineering Command, Philadelphia, PA, August 1991.

Chapter 5

Armed Forces Recipe Service, NAVSUP P-7, Department of the Navy, Naval Supply Systems Command, Washington, DC, September 1992.

Foodservice Operations, NAVSUP P-421, Department of the Navy, Naval Supply Systems Command, Washington, DC, November 1990.

Manual of Naval Preventive Medicine, NAVMED P-5010-1, Department of the Navy, Bureau of Medicine and Surgery, Washington, DC, June 1991.

Chapter 6

Armed Forces Recipe Service, NAVSUP P-7, Department of the Navy, Naval Supply Systems Command, Washington, DC, September 1992.

Basic Food Preparation, QM0333, Commandant, U.S. Army Quartermaster School, Fort Lee, VA, 1988.

Foodservice Operations, NAVSUP P-421, Department of the Navy, Naval Supply Systems Command, Washington, DC, November 1990.

Manual of Naval Preventive Medicine, NAVMED P-5010-1, Department of the Navy, Bureau of Medicine and Surgery, Washington, DC, June 1991.

Chapter 7

Food Service Management, NAVSUP P-486, Department of the Navy, Naval Supply Systems Command, Washington, DC, April 1993.

Foodservice Operations, NAVSUP P-421, Department of the Navy, Naval Supply Systems Command, Washington, DC, November 1990.

Nutritional Allowances, Standards and Education, NAVMEDCOMINST 10110.1, Department of the Navy, Naval Medical Command, Washington, DC, May 1985.

Standards of Food Service, NAVSUPINST 4061.11G, Department of the Navy, Naval Supply Systems Command, Washington, DC, April 1992.

Chapter 8

Armed Forces Recipe Service, NAVSUP P-7, Department of the Navy, Naval Supply Systems Command, Washington, DC, September 1992.

Baking Operations, FM 10-22, Headquarters, Department of the Army, Washington, DC, 1987.

Bread Baking, QM0486, Commandant, U.S. Army Quartermaster School, Fort Lee, VA, 1988.

Foodservice Operations, NAVSUP P-421, Department of the Navy, Naval Supply Systems Command, Washington, DC, November 1990.

Manual of Naval Preventive Medicine, NAVMED P-5010-1, Department of the Navy, Bureau of Medicine and Surgery, Washington, DC, June 1991.

Preparation and Serving of Special Food Items, QM0471, Commandant, U.S. Army Quartermaster School, Fort Lee, VA, 1988.

Chapter 9

Foodservice Operations, NAVSUP P-421, Department of the Navy, Naval Supply Systems Command, Washington, DC, November 1990.

Food Service Management, NAVSUP P-486, Department of the Navy, Naval Supply Systems Command, Washington, DC, April 1993.

Manual of Naval Preventive Medicine, NAVMED P-5010-1, Department of the Navy, Bureau of Medicine and Surgery, Washington, DC, June 1991.

Navy Customer Service Manual, NAVEDTRA 10119-B1, Department of the Navy, Chief of Naval Education and Training, Naval Education and Training Program Management Support Activity, Pensacola, FL, 1988.

Personal Qualification Standard, NAVEDTRA 43532-2, Department of the Navy, Chief of Navy Education and Training, Pensacola, FL April 1989.

Chapter 10

Adequacy, Assignment, and Occupancy of Navy Bachelor Quarters, OPNAVINST 11103.1A, Department of the Navy, Chief of Naval Operations, 1 March 1992.

Financial Management Policies and Procedures for Morale, Welfare, and Recreation Programs, NAVSO P-3520, Department of the Navy, Chief of Naval Operations, Washington, DC, July 1990.

Navy Bachelor Quarters Manual, NAVPERS 15606, Department of the Navy, Bureau of Naval Personnel, February 1992.

Navy Customer Service Manual, NAVEDTRA 10119-B1, Department of the Navy, Naval Education and Training Program Management Support Activity, Pensacola, FL, 1988.

Chapter 11

Basic Doctrine for Army Field Feeding, FM 10-23, Headquarters, Department of the Army, December 1991.

Manual of Naval Preventive Medicine, NAVMED P-5010, chapter 5, "Water Supply Ashore," Department of the Navy, Bureau of Medicine and Surgery, Washington, DC, June 1991.

Marine Corps Expeditionary Combat Field Feeding Workbook, P-MCBCL 1179, Marine Corps Service Support Schools, Marine Corps Base, Camp Lejeune, NC, December 1991.

Operator, Organizational and Direct Support Maintenance Manual for Tent, Kitchen; Flyproof; M1948, TM 10-8340-205-13, Headquarters, Department of the Army, August 1972.

Technical Manual Operator, Organizational and Direct Support Maintenance Manual Including Repair Parts and Special Tools List for Range Outfit, Field, Gasoline, Model M59, TM 10-7360-204-13&P, Headquarters, Department of the Army, July 1983.

Chapter 12

Federal Supply Catalog, Group 89, Subsistence, Department of the Navy, Naval Supply Systems Command, Washington, DC, October 1989.

Food Service Management, NAVSUP P-486, Department of the Navy, Naval Supply Systems Command, Washington, DC, April 1993.

Navy Food Service Evaluation Program Ashore, OPNAVINST 5040.1613, Department of the Navy, Chief of Naval Operations, Washington, DC, November 1984.

Chapter 13

Afloat Supply Procedures, NAVSUP P-485, Department of the Navy, Naval Supply Systems Command, Washington, DC, 1991.

Cost Control Manual for Messes and Consolidated Package Stores Ashore, BUPERSINST 7010.13, Department of the Navy, Bureau of Naval Personnel, Washington, DC, April 1978.

Food Service Management, NAVSUP P-486, Department of the Navy, Naval Supply Systems Command, Washington, DC, April 1993.

Navy and Marine Corps Records Disposition Manual, SECNAVINST 5212.5C, Department of the Navy, Secretary of the Navy, December 1990.

Naval Military Personnel Manual (MILPERSMAN), NAVPERS 15560C, change 7, Article 1119-2, Department of the Navy, Bureau of Naval Personnel, Washington, DC, July 1993.

Self-Help Program in Support of the Navy Real Property Maintenance Program, OPNAVINST 11000.8H, Department of the Navy, Chief of Naval Operations, Washington, DC, July 1990.

APPENDIX II

GLOSSARY

- ABSORPTION**—(Baking term) Refers to the property of flour to absorb and hold liquid. (Frying) Refers to fat absorption in food products as they are fried in deep fat.
- ACIDITY**—Sourness or tartness in a food product; a condition indicating excess fermentation in yeast dough; with soda, generates carbon dioxide for leavening in cakes.
- AERATION**—The treatment of dough or batter by charging with gas to produce a volume increase; to induce air so that amass becomes lighter or fluffier.
- AEROBIC BACTERIA**—Those that require the presence of free oxygen, such as found in the air, for growth.
- AGING**—A flavor-enhancing process usually applied to beef. The meat is hung in a temperature-controlled room for a specific period of time. During this time a chemical reaction occurs in the meat; it becomes more tender because of the partial “digestion” of the connective tissue in the meat. Aged flavor is noticeable after 21 days at chill temperatures.
- A LA KING**—Food served with a rich cream sauce usually containing green peppers and pimentos and sometimes mushrooms or onions.
- ALA MODE**—In a fashion or the style of; for example, desserts served with ice cream or pot roast of beef cooked with vegetables.
- ALBUMEN**—Egg white.
- ALMOND PASTE**—A confection ingredient made of finely ground almonds and sugar.
- AMBROSIA**—(Greek mythology) Descriptive term applying to any food or drink exquisitely gratifying in taste or scent; the name of a favorite southern dessert made of oranges, bananas, pineapple, and shredded coconut.
- AMOEBIA**—One of the simplest forms of animal life; grows in water.
- ANAEROBIC BACTERIA**—Those that grow in an absence of free oxygen, deriving oxygen from solid or liquid materials and producing toxic substances.
- ANGLAISE**—(French) English, a la anglaise means “in English style,” as consommé anglaise.
- ANTIPASTI**—(or Antipasto) (Italian) An appetizer, or a spicy first course consisting of relishes, cold sliced meats rolled with or without stuffings, fish, or other hors d’oeuvres eaten with a fork.
- ANTISEPTIC**—An agent that may or may not kill microorganisms, but does inhibit their growth. Peroxide is an example.
- APPETIZER**—A small portion of food or drink before, or as the first course of, a meal. These include a wide assortment of items ranging from cocktails, canapes, and hors d’oeuvres to plain fruit juices. The function of an appetizer is to pep up the appetite.
- ASPIC**—(French) A molded jelly made from different preparations. The base is gelatin which sets the mixture. Various liquids may be used, but tomato juice is most common. Recipes may require chopped vegetables, fish, poultry, or meats in aspic.
- AU GRATIN**—(French) Food creamed or moistened with eggs, milk, or stock, covered with bread crumbs and butter or cheese, and baked until the top is brown.
- AU JUS**—(French) With natural juice. Roast rib au jus, for example, is beef served with unthickened gravy.
- AU NATUREL**—(French) In a natural manner. A dish served in a simple style.
- BACILLI**—Cylindrical or rod-shaped bacteria responsible for such diseases as botulism, typhoid fever, and tuberculosis.
- BACTERIA**—Microscopic, one-celled organisms found in soil, water, and most material throughout nature. Some are responsible for disease and food spoilage, others are useful in industrial fermentation.
- BACTERICIDE**—Any substance that kills bacteria and related forms of life.
- BAKE**—To cook by dry heat in an oven either covered or uncovered. Usually called roasting when referring to meats.

- BARBECUE**—To roast slowly, basting with a highly seasoned sauce.
- BASTE**—To moisten foods while cooking, especially while roasting meat. Melted fat, meat drippings, stock, water and fat, or water may be used.
- BATTER**—A homogeneous mixture of ingredients with liquid to make a mass that is semiliquid.
- BAVARIAN CABBAGE**—(German) Sautéed cabbage with onions and vinegar.
- BAVARIAN CREAM**—(German) A variation of soft custard into which gelatin and whipped cream and sometimes egg whites and flavoring are folded.
- BEAT**—To blend and introduce air by using a rapid over-and-over or rotary motion.
- BECHAMEL SAUCE**—(French) A seasoned cream sauce with meat stock; egg yolks may be added for color and different consistency. Used for vegetables, meat, fish, and poultry.
- BENCH TOLERANCE**—(Baking term) The property of dough to ferment at a rate slow enough to prevent overfermentation while dough is being made up into units on the bench.
- BISQUE**—(French) A thick soup usually made with a white sauce base and containing fish, shellfish, chicken, or cooked meat. Ingredients are pureed. Also, a rich frozen dessert, often containing powdered nuts or macaroons.
- BLANCH**—1. To partially cook in hot, deep fat for a short time until clear but not brown. Used for potatoes. 2. To rinse with boiling water, drain, and rinse with cold water. Used for rice, macaroni, and other pastas to prevent sticking. 3. A method used to remove skins from almonds.
- BLANCMANGE**—(French) Literally, “white food.” A pudding thickened with cornstarch only.
- BLEEDING**—Dough that has been cut and left unsealed at the cut, thus permitting the escape of leavening gas. Also applies to icing that bleeds.
- BLEND**—To thoroughly mix two or more ingredients.
- BOIL**—To cook in a liquid that bubbles actively during the time of cooking. The boiling temperature at sea level is 212°F.
- BOTULINUS**—A deadly bacterium that develops in canned foods that have been improperly canned.
- BOUILLON**—(French) A clear soup made from beef or chicken stock. May be used as a soup or gravy base. Obtainable in cubes or powder for reconstituting.
- BOWL KNIFE**—A spatula or flexible dull-edge knife used to scrape batter or dough from bowl sides.
- BRAISE**—To brown meat or vegetables in a small amount of fat, then to cook slowly, covered, at simmering temperature (185°F to 210°F) in a small amount of liquid. The liquid may be juices from meat or added water, milk, or meat stock
- BRAN**—Skin or outer covering of the wheat kernel.
- BREAD**—To cover with crumbs or other suitable dry coating ingredient; or to dredge in a mixture of flour, seasonings, and/or condiments, dip in a mixture of milk and slightly beaten eggs and then dredge in bread crumbs.
- BROIL**—To cook under or over direct heat; to grill. No liquid is added. Oven—to cook in an oven, uncovered. Griddle—to cook uncovered on a hot griddle, removing grease as it accumulates.
- BROWN**—To seal juices inside a piece of food by searing its surfaces on a hot griddle or pan.
- BRUNSWICK STEW**—A main dish composed of a combination of poultry, meats, and vegetables.
- BUTTERFLY**—A method of cutting double chops (usually pork) from boneless loin strips. The double chops are joined by a thin layer of meat.
- BUTTERHORNS**—Basic sweet dough cut and shaped like horns.
- BUTTERSCOTCH**—A flavor produced by the use of butter and brown sugar.
- BUTTER SPONGE**—Cake made from sponge cake batter to which shortening has been added.
- CACCIATORE**—(Italian) Refers to a chicken cooked “hunter” style. Browned chicken is braised in a sauce made with tomatoes, other vegetables, stock and herbs.
- CAMEBERT**—Soft, full-flavored cheese.
- CANAPE**—(French) An appetizer eaten with the fingers, served either hot or cold. Small pieces of bread, toast, or crackers topped with a tasty spread.
- CANDY**—To cook in sugar or syrup.
- CAPON**—A young male bird that has been castrated at an early age, to improve the flavor, and fattened.

- CARAMELIZE**—To heat sugar or food containing sugar until sugar melts and a brown color and characteristic flavor develops.
- CARAMELIZED SUGAR**—Dry sugar heated with constant stirring until melted and dark in color, used for flavoring and coloring.
- CARBOHYDRATES**—Sugars and starches derived chiefly from fruits and vegetable sources that contain set amounts of carbon, hydrogen, and oxygen.
- CARBON DIOXIDE**—A colorless, tasteless, edible gas obtained during fermentation or from a combination of soda and acid.
- CARDAMON**—Seed of an East Indian spice plant used for flavoring.
- CARRIERS**—Persons who harbor and send out germs without having symptoms of a disease. The individual has either had the disease at one time and continues to excrete the organism, or has never manifested symptoms because of good resistance to the disease.
- CHIFFONADE**—(or Chiffonade) (French) A method of cutting foods into fine strips to be used as garnished. (See Julienne.)
- CHIFFONADE DRESSING**—A salad dressing containing strips of hard-cooked eggs and beets.
- CHIFFON CAKE**—A sponge cake contacting liquid shortening.
- CHIFFON PIE**—A pie shell filled with a rich custard-type filling into which whipped egg whites and/or cream have been folded.
- CHILI**—(Spanish) A pepper or its fruit. Dried chili peppers are ground into chili powder.
- CHILI CON CARNE**—(Mexican) A dish consisting of ground beef and beans seasoned with chili powder.
- CHOP**—To cut food into irregular small pieces with a knife or chopper.
- CHOP SUEY**—A thick stew originating in American-Chinese restaurants, composed of thin slices of pork and various vegetables, among which is a generous amount of bean sprouts, celery, and onions.
- COAGULATE**—To curdle, clot, congeal, or solidify.
- CHOUX PASTE**—A pastry dough interlayered with butter or shortening to attain flakiness; leavened during baking by the internally generated steam; used to make eclairs and cream puffs; also called puff paste.
- CHUTNEY**—A pickle relish originating in India. Many kinds and amounts of different ingredients are used.
- COAT**—To cover entire surface of food with a given mixture.
- COMPOUNDS**—(Baking term) Certain mixtures of fats and oils.
- CONDIMENTS**—Substances that in themselves furnish little nourishment but have stimulating flavor.
- CONGEALING POINT**—Temperature at which a liquid changes to a plastic or solid.
- CONSOMME**—(French) A clear soup made from two or more kinds of concentrated meat stock.
- COOKING LOSSES**—Weight loss, loss of nutrients, and possibly a lowered palatability resulting from cooking finds.
- CORN**—A method of preserving and seasoning with salt brine and other preservatives.
- CREAMING**—The process of mixing and aerating shortening and another solid, such as sugar or flour; to thoroughly blend.
- CREAM PUFFS**—Baked puffs of cream puff dough that are hollow; usually filled with whipped cream or cooked custard.
- CREOLE**—A sauce cooked and used over poultry served with rice or a casserole dish of poultry or seafood and rice cooked in such a sauce.
- CRESCENT ROLLS**—Hard-crust rolls shaped into crescents, often with seeds on top.
- CRIPPLE**—A misshapen, burnt, or otherwise undesirable baked item.
- CROQUETTE**—(French) A product made by incorporating a minced vegetable, fish, poultry, or meat into shaped balls or cones that are rolled in crumbs and fried.
- CROUTONS**—(French) Bread cut into small, cubed pieces and either fried or browned in the oven, depending upon the intended use. They are fried for use as a garnish or baked when used as an accompaniment for soup.

CRULLERS—Long, twisted, baking powder doughnuts.

CRUSTING—Formation of dry crust on surface of doughs due to evaporation of water from the surface.

CUBE—To cut any food into square-shaped pieces.

CURDLE—To change into curd; to coagulate or thicken.

CURRENT—The acid berry of several species of shrubs of the gooseberry family; used primarily for jelly and jam.

CURRY—A powder made from many spices and used as a seasoning for Indian and Oriental dishes (shrimp or chicken curry).

CUT IN—Baking term that means to combine solid shortening and flour with a pastry blender or knife.

DANISH PASTRY—A flaky yeast dough having butter or shortening rolled into it.

DASH—A scant one-eighth teaspoon.

DEMITASSE—A half cup. In this country, the term is applied to after-dinner coffee, which is usually served in half-size cups. Demitasse coffee is usually made stronger than that served with a meal.

DIASTASE—An enzyme possessing the power to convert starches into dextrose and maltose.

DICE—To cut into cubes of approximately one-fourth inch.

DISINFECTANT—A chemical agent that destroys bacterial and other harmful organisms.

DISSOLVE—To mix a solid dry substance with a liquid until solid is in solution.

DIVIDER—(Baking term) A machine used to cut dough into a desired size or weight.

DOCK—To punch a number of vertical impressions in a dough with a smooth round stick about the size of a pencil to allow for expansion and permit gas to escape during baking.

DOUGH—The thickened uncooked mass of combined ingredients or bread, rolls, and cookies, but usually applied to bread.

DRAWN BUTTER—(or Sauce) When salted butter is melted, the salt separates from the oil and settles. The oily portion is poured, or “drawn” off, hence, the name. Drawn butter may be used unthickened, seasoned with a little lemon or a dash of

Worcestershire sauce and a bit of chopped parsley, chives, or mint. Drawn butter sauce is a thickened sauce made from drawn butter and used with fish, shellfish, and green vegetables.

DREDGE—To coat food items with flour, sugar, or meal.

DRESS—As applied to food: to prepare for cooking or for the table, as to dress a chicken.

DRIPPINGS—Fat and juices dripped from roasted meat.

DRY YEAST—A dehydrated form of yeast.

DUCHESS—(or Duchesses) A name given to various mixtures to which beaten whole eggs (or whites only in some dessert items) are added. The mixture is shaped into balls and baked. A method used most often with mashed potatoes.

DUSTING—A light film of flour or starch that is placed on pans or workbench to prevent dough from sticking.

ECLAIR—(French) A small filled pastry made from cream puff batter (or choux paste). The filling varies, but usually is vanilla cream filling or whipped cream injected from a special tube filler. The baked, filled shell is dusted with confectioners’ sugar or covered with a thin layer of chocolate.

EMULSIFICATION—The process of blending together fat and water solutions to produce a stable mixture that will not separate on standing.

ENCHILADAS—(Mexican) A dish popular in many parts of the United States consisting of tortillas topped with a meat sauce and cheese.

ENRICHED BREAD—Bread made from enriched flour and containing federally prescribed amounts of thiamin, riboflavin, iron, and niacin.

ENTRÉE—(French) An intermediary course of a meal, which in the United States is the “main” course.

ENZYME—A substance produced by living organisms that has the power to bring about changes in organic materials.

EXTRACT—Essence of fruits or spices used for flavoring.

FERMENTATION—The chemical change of an organic compound due to action of living organisms (yeast or bacteria), usually producing a leavening gas.

- FIESTA**—(Spanish) Designates a special recipe used on holidays in Spain.
- FILET**—(French) Designates a French method of dressing fish, poultry, or meat to exclude bones and include whole muscle strips. The English term is *fillet*.
- FILET CHATEAUBRIAND**—Extra thick filet mignon, Russian style, baked in the oven.
- FILET MIGNON**—May be tenderloin of beef, mutton, veal, or pork.
- FINGER ROLL**—A bun about 5 inches by 1 inch in size.
- FLOUR:**
- BLEACHED FLOUR**—Flour that has been treated by a chemical to remove its natural color and make it white.
- BOLTING**—Sifting of ground grain to remove the bran and coarse particles.
- CLEAR FLOUR**—Lower grade and higher ash content flour remaining after the patent flour has been separated.
- PATENT FLOUR**—The flour made from the choice, inner portion of the wheat grain.
- STRAIGHT FLOUR**—Flour containing all the wheat grain except the bran, termed 100 percent.
- STRONG FLOUR**—One that is suitable for the production of bread of good volume and quality because of its gas retaining qualities.
- WATER ABSORPTION**—The ability of flour to absorb water. Factors that affect this ability are age of the flour, moisture content, wheat from which it is milled, storage conditions, and milling process.
- FLUFF**—A mass of beaten egg white, air, and crushed fruit.
- FOAM**—Mass of beaten egg and sugar, as in sponge cake before the flour is added.
- FOLD IN**—To combine ingredients very gently with an up-and-over motion, lifting one ingredient up through the others.
- FONDUE**—A dish made of melted cheese, butter, eggs, milk, and bread crumbs. The dish has many variations.
- FOOD INFECTION**—A foodborne illness that is obtained from ingesting foods carrying bacteria that later multiply within the body and produce disease.
- FOOD POISONING**—Food intoxication. A foodborne illness contracted through ingesting food containing some poisonous substance.
- FOO YOUNG**—(Chinese) A dish made with scrambled eggs or omelet with cut Chinese vegetables, onions, and meat. Usually, the dish is served with a sauce.
- FORMULA**—In baking, a recipe giving ingredients, amounts to be used, and the method of preparing the finished product.
- FRANCONIA**—(German) An ancient German territory. In culinary sense, means “browned,” as whole potatoes browned with roast.
- FREEZE DRYING**—Drying method where the product is first frozen and then placed in a vacuum chamber (freeze dehydration). Aided by small controlled inputs of thermal or microwave energy, the moisture in the product passes directly from the ice-crystalline state to moisture vapor and is evacuated.
- FRENCH BREAD**—An unsweetened, crusty bread, baked in a narrow loaf, and containing little or no shortening.
- FRENCHING**—A method of preparing boneless veal or pork chops by flattening with a cleaver.
- FRICASSEE**—To cook by braising; usually applied to poultry or veal cut into pieces.
- FRITTERS**—Originally a small portion of fruit dipped in batter and fried. The term now includes plain fried balls of batter or balls containing chopped meat, poultry, fruit, or vegetables.
- FRIZZLE**—To cook in a small amount of fat until food is crisp and curled at the edges; a meat crimped, frizzed, or curled at the edges, as frizzled dried beef and scrambled eggs.
- FRY**—To cook in hot fat. When a small amount of fat is used, the process is known as panfrying or sautéing; when food is partially covered by the fat, shallow frying; and when food is completely covered, deep-fat frying.
- FUMIGANT**—A gaseous or colloidal substance used to destroy insects or pests.
- FUNGICIDE**—An agent that destroys fungi.

- GARNISH**—To decorate a dish with colorful, savory food items, such as sprigs of parsley placed around fish or potatoes or a colorful bit of fruit added to a dessert.
- GELATINIZE**—The swelling of starch particles in hot water.
- GERM**—A pathogenic, or disease-producing, bacterium; a living substance capable of developing into an animal or plant.
- GERMICIDE**—An agent capable of destroying germs.
- GLAZE**—A thin sugar syrup coating (or a thickened sugar mixture) used for coating pastries, cakes, and meats.
- GLUCOSE**—A simple sugar made by action of acid on starch. It is made chiefly from cornstarch and is usually referred to as corn syrup.
- GLUTEN**—The elastic protein mass that is formed when flour is mixed with water. Composed of two proteins: gliadin for elasticity and glutenin for strength.
- GOULASH**—(Hungarian) A national stew of Hungary, variously made in the United States of either beef, veal, or frankfurters with onions and potatoes. A covering sauce has tomato paste and paprika as ingredients. It may be served with sour cream.
- GRAHAM FLOUR**—Finely ground whole wheat flour.
- GRAINING**—Refers to the formation of crystals in a cooled sugar solution after it has been boiled. If cooling is slow, large crystals will form. Rapid cooling produces small crystals. Small, fine crystallization, desired in making fondant, is accomplished by rapid mixing during cooling.
- GRATE**—To pulverize food items by rubbing on the rough surface of a grater,
- GREASE**—To rub utensil with grease (butter or other fat) preparatory to putting a food material in it to be cooked.
- GRILL**—To cook, uncovered on a griddle, removing grease as it accumulates. No liquid is added.
- GUMBO**—A creole dish, resembling soup, that is thickened with okra, its characteristic ingredient.
- HARD SAUCE**—A dessert sauce made of butter and confectioners' sugar thoroughly creamed. The mixture is thinned or tempered with either boiling water or spirits.
- HASH**—A dish made of chopped or minced meat and/or vegetable mixture in brown stock.
- HEARTH**—The heated baking surface of the floor of an oven.
- HERMITS**—A rich short-flake cookie.
- HOLLANDAISE**—A hot sauce made with egg yolks and butter and served with vegetables.
- HORS D'OEUVRES**—(French) Light snack-type food eaten hot or cold at the beginning of a meal. These foods correspond to the Italian antipasto and the Scandinavian smorgasbord.
- HOST**—Any living animal or plant affording food for growth to a parasite.
- HOT CROSS BUNS**—A sweet, spicy, fruity bun with a cross cut on the top that is usually filled with a plain frosting.
- HUMIDITY**—Usually expressed as relative humidity. The capacity of air to retain moisture varies with its temperature. Thus, relative humidity is the present moisture content related to total moisture capacity for the present temperature and stated as a percent.
- HUSH PUPPIES**—A bread served mostly in the South with fish and is made by deep frying cornbread batter seasoned with onions.
- HYDROGENATED OIL**—A natural oil that has been treated with hydrogen to convert it to a hardened form.
- INCUBATION PERIOD**—That time between entrance of disease-producing bacteria in a person and the first appearance of symptoms.
- INSECTICIDE**—Any chemical substance used for the destruction of insects.
- INVERT SUGAR**—A mixture of dextrose and levulose made by inverting sucrose with acid or enzymes.
- ITALIENNE**—(French) Refers to Italian style of cooking.
- JAMBALAYA**—A creole rice-tomato dish with fish, shellfish, or meat.
- JARDINIERE**—(French) A meat dish or a garnish, "garden" style, made of several kinds of vegetables.
- JELLY WREATH**—A rolled ring of basic sweet dough containing jelly.
- JULIENNE**—(French) A way of cutting vegetables, meat, or poultry into fine strips or shreds.

- KEBAB**—(Turkey) A combination of cubes of meat, usually lamb, and chunks of vegetables or fruit, placed alternately on a skewer and broiled.
- KNEAD**—To alternately press and turn and fold dough with the hands for the purpose of expelling gas and redistributing the yeast.
- KOLACHES**—(Czechoslovakia or Bohemia) A bun made from a soft dough topped with fruit, nuts, fruit-nut, or seed fillings.
- LACTIC ACID**—An organic acid sometimes known as the acid of milk because it is produced when milk sours. Souring is caused by bacteria.
- LACTOSE**—The sugar of milk.
- LADY FINGERS**—A cookie made with a sponge cake batter and baked in special pans.
- LARDING**—To cover uncooked lean meat or fish with strips of fat, or to insert strips of fat with a skewer.
- LASAGNA**—(Italian) A baked Italian dish with broad noodles, or lasagna macaroni, which has been cooked, drained, and combined in alternate layers with Italian meat sauce and two or three types of cheese (cottage, ricotta, parmesan, or mozzarella).
- LEAVENING**—Raising or lightening by air, steam, or gas (carbon dioxide). Usually, the agent for generating gas in a dough or batter is yeast or baking powder.
- LEVULOSE**—A simple sugar found in honey, fruits, and invert sugar.
- LYONNAISE**—(French) A seasoning with onions and parsley originating in Lyons, France. Sautéed potatoes, green beans, and other vegetables are seasoned this way.
- MACAROON**—A rich, chewy cookie made with almond paste and shredded coconut.
- MACEDOINE**—(French) A name derived from the country of Macedonia; refers to a mixture of fruits or vegetables used for garnish or as a cocktail.
- MADRILENE**—(French) A name of a clear soup; other dishes flavored with tomato juice.
- MAGENTA**—(Italian) A purplish shade of red produced by the use of tomato juice as, for example, in soup.
- MAITRE D'HOTEL**—(French) Head waiter; also a butter sauce used on fish.
- MAKEUP**—Manual or mechanical manipulation of dough to provide a desired size and shape.
- MALT EXTRACT**—A syrupy liquid obtained from malt mash; a product obtained as a result of converting the starch to sugar.
- MARBLE CAKE**—A cake of two or three colored batters swirled together so that the finished product retains the separate colors.
- MARBLING**—The intermingling of fat with lean in meat muscles. The presence or absence of marbling can be seen on the surface of meat that has been cut across the grain. The presence of marbling indicates quality and palatability of meat.
- MARINATE**—To cover food with a marinade (a preparation containing spices, vegetables, herbs, and a liquid, usually acid) and let stand for a period of time to enhance its flavor and improve its tenderness.
- MARMALADE**—A thick, pulpy jam or preserve made with crushed fruits. Marmalades made of citrus fruits contain bits of the peel.
- MARZIPAN**—A confection of almonds reduced to a paste with sugar and used for modeling, masking, and torte.
- MASKING**—To cover completely with a sauce, jelly aspic, mayonnaise, cream, icing, or frosting.
- MEAT SUBSTITUTE**—Any food that may be used as an entrée that does not contain beef, veal, pork, or lamb. The substitutes are protein-rich dishes such as eggs, fish, dried beans, and cheese.
- MELBA**—A cornstarch dessert sauce most frequently used with peaches; a very thin toasted bread is called melba toast.
- MELTING POINT**—The temperature at which a solid becomes a liquid.
- MERINGUE**—A white frothy mass of beaten egg whites and sugar.
- MIDLINGS**—Granular particles of the endosperm of wheat that are removed during milling.
- MILANAISE**—(French) Foods prepared a la milanaise contain eggs, parmesan cheese, and bread crumbs. Rice and macaroni products prepared ala milanaise may be formed into different shapes, dipped into egg batter, rolled in bread crumbs, fried, or paned and baked.

- MINCE**—To cut or chop into very small pieces (finer than chopped).
- MINISTRONE**—(Italian) Thickened vegetable soup containing lentils or beans.
- MIXING**—To unite two or more ingredients.
- MOCHA**—A variety of favorable coffee from Mocha (Arabia) but refers to any coffee today, including the instant form. A rich butter cream icing containing cocoa and coffee essence.
- MOLD**—Microscopic, multicellular, threadlike fungi growing on moist surfaces or organic material.
- MORNAY**—A cheese sauce used principally with baked fish.
- MOUSSE**—(French) The word means “froth.” Mousse is a cold entrée (meat, poultry, or seafood mousse) or a frozen dessert. The basic ingredients are beaten eggs, whipped cream, and gelatin.
- MULLIGATAWNY**—(East Indian) A soup with a chicken stock base highly seasoned, chiefly by curry powder.
- MYOCIDE**—An agent that destroys molds.
- NAPOLEON**—A pastry made from choux (or puff paste) rolled very thin, baked, cooled, and layered with cream filling. Usually topped with icing or confectioners’ sugar.
- NEWBURG**—A dish made with a cream sauce containing egg yolks and, sometimes, wine. Customarily used with seafood.
- NORMANDY**—(French) A province of France famous for its cuisine. Dishes prepared “à la normandé or normandie” contain generous amounts of butter and/or cream.
- NUTRIENT**—A substance in food that the human is known to require to support life and health.
- O’BRIEN**—A style of preparing sautéed vegetables with diced green peppers and pimentos. (Corn O’Brien and O’Brien potatoes are examples.)
- OLD DOUGH**—Yeast dough that is fermented for too long a time. It produces a baked loaf that has a dark crumb color, sour flavor, low volume, coarse grain, and tough texture.
- OMELET**—(or French: omelette) Eggs cooked with yolks and whites beaten together or separately and blended, depending upon the type of omelet.
- PANBROIL**—To cook uncovered in a hot frying pan, pouring off fat as it accumulates.
- PARASITES**—Organisms that live in or on a living host that they usually do not destroy.
- PARBOIL**—To boil in water until partially cooked.
- PARE**—To cut away outer covering.
- PARFAIT**—(French) Refers to cookery perfection but is most often associated with variously prepared desserts. The basic foundation is a sugar syrup enriched with eggs and/or cream and stabilized with gelatin. Fruits, liqueurs, or other flavorings are used with the soft mixture or with ice-cream parfaits.
- PARKERHOUSE ROLLS**—Folded buns of fairly rich dough.
- PARMESAN**—(Italian) A very hard cheese originating in the Parma region of Italy.
- PASTA**—(or Paste) (Italian) A term referring to macaroni products, including spaghetti, noodles, and other pastes made from hard wheat (durum or semolina).
- PEEL**—To remove skin, using a knife or peeling machine.
- PEPPER POT**—A highly seasoned soup or stew.
- PETIT FOURS**—Small decorated squares of cake.
- PICKLE**—A method of preserving food by a salt and water (or vinegar) solution.
- PILAF**—(also Pilau) An Oriental or Turkish dish made of rice. The cooking liquid used is beef or chicken stock, mildly flavored with onions.
- PIQUANT**—(French) A tart, pleasantly sharp flavor. A piquant sauce or dressing contains lemon juice or vinegar.
- POACH**—Method of cooking food in a hot liquid that is kept just below the boiling point.
- POLONAISE**—(French) A garnish used on such vegetables as cauliflower, asparagus, or other dishes consisting of chopped egg and parsley. Bread crumbs may also be added.
- PORCUPINES**—A meat dish prepared with ground beef and rice, formed into balls, and baked.
- POULTRY TERMS:**
- DRAWN**—Killed and feathers and intestines removed.
- DRESSED**—Killed and feathers removed.

- EVISцерATED**—Dressed, drawn, and cut up ready to cook.
- FIRST JOINT**—Wing joint next to carcass.
- GIBLETS**—Heart, gizzard, and liver of poultry cooked and chopped for use in gravy. The neck and wingtips may be also used as gIBLETS.
- OYSTER MUSCLE**—Tender, oval dark meat that is found in recess on either side of back, above the wings.
- READY TO COOK**—See Eviscerated.
- SECOND JOINT**—The portion Of the wing between the first joint and the wingtip. Also the thigh portion of the leg.
- PROOF BOX**—A tightly closed box or cabinet equipped with shelves to permit the introduction of heat and humidity. Used for fermenting dough.
- PROOFING PERIOD**—The time during which dough rises between molding and baking.
- PROVOLONI**—(Italian) A cured hard cheese that has a smoky flavor.
- PUFF PASTE**—See Choux Paste.
- PUREE**—To press fruit, vegetables or other solid foods through a sieve, food mill, or blender; also a soup made with pureed foods combined with white sauce, cream, or stock.
- QUAHAUG**—(or Quahog) Indian name for hard clam.
- QUICK BREADS**—Bread products baked from a lean chemically leavened batter.
- RABBIT**—(or Rarebit) A melted cheese dish.
- RACK**—The unsplit rib section of lamb or veal carcass after the breast meat cakes.
- SAFE HOLDING TEMPERATURES**—A range of cold and hot temperatures considered safe for holding potentially hazardous foods including refrigeration temperatures, 40°F or below, and heating temperatures, 140°F or above.
- SALISBURY STEAK**—A ground meat dish cooked with onions and made to resemble steak in shape. Sometimes referred to as hamburger steak.
- SALLY LUNN**—A bread used principally in the southern United States and named for the woman who is said to have first made it. It may be made either as a quick bread or raised with yeast; baked either in muffin tins or in a flat pan and cut into squares.
- SANITIZE**—Effective bactericidal treatment of clean surfaces of equipment and utensils by an established process.
- SATURATION**—Absorption to the limit of capacity.
- SAUERBRATEN**—(German) A beef pot roast cooked in a sour sauce variously prepared with spices and vinegar and sometimes served with sour cream.
- SAUTÉ**—To panfry lightly and quickly in a very little hot fat, turning frequently.
- SCALD**—To heat a liquid to just below the boiling point.
- SCALING**—(Bating term) Apportioning batter or dough according to unit of weight.
- SCALLOP**—To bake food, usually cut in small pieces, with a sauce or other liquid. Topping of crumbs or shredded cheese frequently used.
- SCONE**—A shortcake, containing raisins, that has an egg-milk wash and cinnamon topping to give a colorful, rich crust.
- SCORE**—To cut shallow slits or gashes in surface of food with a knife, fork, or another implement.
- SCOTCH BROTH**—A soup made with lamb stock, barley, and vegetables.
- SCOTCH WOODCOCK**—An egg baked with cheese sauce and a bread crumb topping.
- SEAR**—To brown the surface of meat by a short application of intense heat.
- SHRED**—To cut or tear into thin strips or pieces using a knife or shredder.
- SIFTING**—Passing through a fine sieve for effective blending, to remove foreign or oversize particles, and to aerate.
- SIMMER**—To cook in liquid at a temperature just below the boiling point (190°F-210°F); bubbles will form slowly and break below the surface.
- SINGLE SERVICE**—Refers to disposable articles used for food preparation, eating, or drinking utensils constructed wholly or in part from paper or synthetic materials and intended for one-time use.
- SKEWER**—A wood or metal pin used to hold meat or other foods in shape while cooking.
- SKIM**—To remove floating matter from the surface of a liquid with a spoon, ladle, or skimmer.

- SLACK DOUGH**—Dough that is soft and extensible but which has lost its resiliency.
- SMORGASBORD**—(Swedish) A Scandinavian luncheon or supper served buffet style at which many different dishes are served, including hot and cold hors d'oeuvres, pickled vegetables and fish, assorted cheeses, jellied salads, fish, and meats.
- SMOTHER**—To cook in a closed container or in a close mass as smothered onions.
- SNAPS**—Small cookies that run flat during baking and become crisp on cooling.
- SNICKER-DOODLE**—A coffee cake with a crumb topping.
- SOLIDIFYING POINT**—Temperature at which a fluid changes to a solid.
- SOUFFLÉ**—(French) A delicate, spongy hot dish made principally of stiffly whipped egg whites. Cheese is commonly used, but other soufflés include fish, meat, poultry, and vegetables. Also prepared as a dessert.
- SPORE**—Any of various primitive reproductive bodies (or resistant resting cells), typically one-celled and produced by certain forms of plant life, especially molds and bacteria, and by some animal microorganisms.
- SPRAY DRYING**—A method of dehydrating liquids by spraying them into a drying chamber into which very hot, dry air is circulated. The rapid evaporation causes a minimum of flavor change in the food.
- STARCH WATER**—A mixture of cornstarch and water made by boiling 1 quart of water containing 1 or 2 tablespoons of cornstarch. This mixture brushed on bread dough gives a shine to the crust after baking.
- STEAM**—To cook in steam with or without pressure.
- STEEP**—To let stand in hot liquid (below boiling temperature) to extract flavor, color, or other qualities from a specific food.
- STERILIZE**—To destroy microorganisms by heat, ultraviolet light, irradiation, chemicals, or antibiotics.
- STEW**—To simmer in enough liquid to cover solid foods.
- STIR**—To blend two or more ingredients with a circular motion.
- STROGANOFF**—A la stroganoff is a method of preparing beef with sour cream.
- SUCCOTASH**—A combination dish consisting of whole-grain corn and lima beans.
- SUGAR**—Cane or beet (sucrose)—most common, usually granulated, sweetening agent. Corn (dextrose)—a form of sugar made from cornstarch and readily fermentable. Maltose—a form of sugar obtained by germinating cereal grain. usually supplied as a syrup. In recipes, refers to granulated unless otherwise specified.
- SUKIYAKI**—(Japanese) A popular Japanese dish consisting of thin slices of meat fried with onions and other vegetables, including bean sprouts and served with soy sauce containing seasoning, herbs, and spices.
- TACO**—(Mexican) An open-face sandwich made of fried tortillas shaped like a shell and filled with a hot meat-vegetable mixture.
- TAMALE**—(Mexican) A steamed dish made of cornmeal with ground beef or chicken rolled in the center, usually highly seasoned.
- TARTAR SAUCE**—A rich sauce made with salad dressing, onions, parsley, pickle relish, and sometimes olives and cucumbers, served with seafood.
- TARTS**—Small pastries with heavy fruit or cream filling.
- TEMPER**—To remove from freezer and place under refrigeration for a period of time sufficient to facilitate separation and handling of frozen product. Internal temperature of the food should be approximately 26°F to 28°F.
- TETRAZINNI**—(Italian) A dish with chicken, green peppers, and onions mixed with spaghetti and served with shredded cheese.
- TEXTURE**—The structure, fineness or coarseness, of a baked product when a cut surface is examined.
- THAW**—To remove from freezer and place under refrigeration until thawed. Internal temperature should be above 30°F.
- TORTE**—Cake, especially of a rich variety; contains nuts, fruits, and usually very little or no flour.
- TORTILLA**—(Mexican) A bread made with white corn flour and water. Special techniques are used in handling the dough to roll it thin as a piecrust. It is usually baked on hot iron.

- TOSS**—To mix ingredients with a gentle lifting, circular motion. Usually used for salad ingredients.
- TOXIN**—A waste product given off by a microorganism causing contamination of food and subsequent illness in human beings.
- TRICHINOSIS**—A foodborne disease transmitted through pork containing a parasite, “Trichinella spiralis,” or its larvae, which infects animals.
- TRUSS**—To bind or fasten together. Usually refers to poultry.
- VACUUM DRYING**—Vacuum is applied to food that causes the air and moisture inside it to expand and create bubbles (a puffing effect). The puffed product is then dried leaving a solid fragile mass. This may be crushed to reduce bulk.
- VERMICELLI**—(Italian) A pasta or macaroni product, slightly yellow in color, shaped like spaghetti, and very thin.
- VIENNA BREAD**—A hearth-type bread with heavy crisp crust, sometimes finished with seed topping.
- VINAIGRETTE**—(French) A mixture of oil and vinegar seasoned with salt, pepper, and herbs that is used in sauces and dressings.
- VIRUS**—A group of submicroscopic organisms that grow in living tissue and may produce disease in animals and plants. Viruses are smaller than bacteria and will pass through membranes or filters.
- WASH**—A liquid mixture brushed on the surface of a product either before or after baking. It may be composed of one or more ingredients (water, milk, starch solution, thin syrup, or eggs).
- WELSH RABBIT**—(English) A cheese sauce served with toasted bread or crackers.
- WHEY**—Liquid remaining after the removal of fat, casein, and other substances from milk.
- WHIP**—To beat rapidly to increase volume by incorporating air; a hand or mechanical beater of wire construction used to whip materials such as cream or egg whites to a frothy consistency.
- YEAST**—A microscopic plant that reproduces by budding and causes fermentation and the giving off of carbon dioxide gas; leavening agent.
- YOUNG DOUGH**—Yeast dough that is underfermented. This produces a baked product with a light color, tight grain, and low volume (heavy).
- ZUCCHINI**—(Italian) Slender green squash.
- ZWIEBACK**—A toast made of bread or plain coffee cake dried in a slow oven.

INDEX

A

Accounting systems, general mess, 3-1
 General Mess Operating Statement, preparation of,
 3-1
 retention of records and documents, 3-3
 submission of returns, 3-1

B

Bachelor quarters ashore, 10-5
 Admiral Zumwalt award, 10-17
 BQ management assistance and inspection team,
 10-18
 BQ management organization, 10-6
 BQ management school, 10-18
 care of quarters, 10-16
 classification of personnel assigned duties in BQs,
 10-6
 operational responsibilities, 10-6
 training, 10-17
Breads, 8-1
 biscuits, 8-14
 breadmaking procedures, 8-4
 fillings and finishes, 8-15
 ingredients, 8-1
 leavening agents, 8-3
 pizza, 8-16
 quickbreads, 8-10
 rolls, 8-8
 yeast-raised breads, 8-1
 yeast-raised doughnuts, 8-14

C

Cash Meal Payment Book, DD Form 1544, 12-16

D

DD Form 200, 2-20

DD Form 1149, 2-17

DD Form 1155, 2-10

DD Form 1348m, 12-8

DD Form 1544, 12-16

Defense against radiological, biological, and chemical
agents, 1-17

 biological contamination, 1-20

 biological decontamination methods, 1-20

 defense against biological agents, 1-19

 defense against chemical agents, 1-22

 defense against radiological agents, 1-17

 monitoring to determine extent of radioactivity,
 1-17

 radiological contamination, 1-17

 radiological decontamination, 1-18

Desserts, 8-16

 cake decorating, 8-18

 cakes, 8-16

 cookies, 8-20

 frostings, 8-19

 other desserts, 8-25

 pastry, 8-25

 pies, 8-21

 sauces, 8-27

DOD Single Line Item Requisition System Document
(manual), Form 1348m, 12-8

E

Emergency and disaster feeding, 13-3

Expenditure Log (Loss without Survey), NAVSUP
Form 1334, 2-19

Expenditures, 2-14

 breakouts, 2-14

 inventory, 2-21

 issues, 2-14

- Expenditure—Continued
- maintenance of receipt and expenditure records, 2-20
 - sale of food items, 2-17
 - surveys, 2-19
 - transfers, 2-16
- F**
- Field kitchens, 11-1
- garbage disposal, 11-4
 - pest control, 11-14
 - storage of food, 11-3
- Field kitchen equipment, 11-7
- field ranges, 11-7
 - improvised stoves, 11-10
 - kitchen equipment arrangement, 11-11
 - loading kitchen equipment, 11-15
 - small detachment cooking outfit, 11-9
 - unloading kitchen equipment, 11-11
- Field kitchen sight selection and layout characteristics, 11-1
- planning kitchen layout, 11-3
 - planning the location, 11-1
- Field kitchen tents, 11-4
- setting up the tent, 11-6
 - striking and storing the kitchen tents, 11-7
 - unpacking the tent, 11-5
- Field sanitation, 11-12
- Food guide pyramid, 7-5,7-7
- fats, oils, and sweets, 7-10
 - fruit group, 7-8
 - grain, cereal, rice, and pasta, group, 7-6
 - meat, poultry, fish, dry beans, eggs, and nuts group, 7-9
 - milk, yogurt, and cheese group, 7-8
 - vegetable group, 7-8
- Food preparation, 5-1
- abbreviations, 5-5
- Food preparation—Continued
- Armed Forces Recipe Service, 5-1
 - basic guides, 5-1
 - beverages, 5-26
 - box lunches, assembly, 5-22
 - cereal, 5-25
 - cooking methods, 5-16
 - dressings, 5-25
 - eggs, 5-13
 - fruits and vegetables, 5-14
 - Food-Preparation Worksheet, NAVSUP Form 1090, 5-1, 5-2
 - gravies, 5-24
 - hors d'oeuvres, 5-19
 - pasta, 5-25
 - recipe adjustment, 5-6
 - salads, 5-17
 - sandwiches, 5-19
 - sanitary aspects, 5-11
 - sanitation, general, 1-4
 - sauces, 5-23
 - soups, 5-23
 - relishes, 5-19
 - rice, 5-25
- Food storage, 2-11
- perishable foods, 2-12
 - principles of storage, 2-11
 - refrigeration units, 2-13
 - refrigerator log, 2-14
 - semiperishable food items, 2-11
- Food-Item Request/Issue Document, NAVSUP Form 1282, 2-14
- Food-Item Report/Master Food Code List, NAVSUP Form 1059, 2-14, 2-21
- Foodborne illnesses, 1-1
- animal parasites, 1-3
 - infection, 1-2

Foodborne illnesses-Continued

- intoxication, 1-2
- molds and yeasts, 1-4
- poisoning, natural or chemical, 1-1

Foodservice attendants, 1-4, 9-5

Foodservice cost control, 12-14

- daily food cost computation, 12-14
- operating limits determination, 12-17

Foodservice equipment, 4-1

- cleaning the dishwashing machine, 4-21
- descaling dishwashing machines, 4-22
- operating the dishwasher, 4-21
- precautions, general, 4-1

Foodservice equipment, types, 4-1

- beverage dispenser, noncarbonated, 4-28
- bread slicer, 4-15
- can opener, 4-28
- coffee makers, 4-25
- deep-fat fryer, 4-4
- dishwashing machines, 4-19
- dough proofers, 4-15
- dough trough, 4-15
- food mixer, electric, 4-10
- garbage grinder, 4-22
- griddle, electric, 4-3
- ice-making machine, bulk, 4-28
- ice-dispensing machine, 4-28
- iced tea dispenser, 4-27
- knives, 4-18
- meat chopper, 4-17
- meat saw, 4-17
- meat tenderizer, 4-18
- meat-slicing machine, electric, 4-11
- milk dispensers, refrigerated, 4-24
- oven, convection, 4-6
- oven, electric, 4-5

Foodservice equipment, types—Continued

- ranges, electric, 4-9
- refrigerators, 4-23
- salad bar, refrigerated, 4-24
- scale, even balance, 5-9, 5-12
- shaper potato mix (extractor), 4-23
- soft-serve ice-cream machine, 4-25
- steamers, 4-12
- steam-jacketed kettles, 4-2
- steam table, 4-23
- toasters, electric, 4-23
- tilting skillet, 4-4
- vegetable cutter, electric, 4-16
- vegetable cutter and slicer, 4-16
- vegetable peelers, 4-16
- ventilator hoods, 4-13

Foodservice management efficiency processes, 13-8

- auditing accounting records, 13-18
- inventory control and physical security, 13-16
- leftovers, control and documentation, 13-9
- monitoring food preparation, 13-8
- monitoring sanitation and training, 13-21
- monitoring temperatures, 13-22
- preventive maintenance, 13-24
- standards of foodservice, 13-8

Foodservice suggestions, 13-9

Foodservice organizational and planning policies, 13-1

- assistance, Navy Food Management Team, 13-6
- guidance, Navy Food Service Systems Office, 13-5
- organization of messing facilities, 13-1

G

General mess foodservice, 9-1

- applicable equipment, 9-1
- serving line areas, 9-2
- serving techniques, 9-4

General Mess Control Record, NAVSUP Form 338, 12-15
General Mess Menu, NAVSUP Form 1080,7-24
General Mess Operating Statement, NAVSUP Form 1358, 3-1

H

Head count procedures, 13-12
 afloat, 13-11
 ashore, 13-11

I

Inventory, 2-21

K

Key custody and controls, 13-17

L

Letters of authority, authorization, and appointment, 13-16

M

Meal Signature Record NAVSUP Form 1291, 13-13

Meat carving, 6-13

Meat, forms, 6-1

 beef, 6-1
 lamb, 6-5
 other, 6-6
 pork, 6-4
 rabbit, 6-6
 veal, 6-5

Meat preparation and cooking methods, 6-6

 dry heat methods, 6-9
 frozen and thawed meats, 6-7
 moist heat methods, 6-8
 thawing methods, 6-7

Menu Draft, NAVSUP Form 1092, 7-22

Menu planning, 7-10

 acceptability factors, 7-12

Menu planning—Continued

 cycle menu system, 7-16
 drafting the menu, 7-21
 factors affecting menus, 7-10
 frequency charts, 7-17
 guides, 7-16
 menu boards, 7-20
 menu changes, 7-20
 menu-planning tools, 7-11
 special menus, 7-24
 wardroom menus, 7-25

N

NAVSUP Form 335, 2-8

NAVSUP Form 338, 12-15

NAVSUP Form 340, 12-17

NAVSUP Form 367, 2-10

NAVSUP Form 1046, 13-21

NAVSUP Form 1059, 2-14, 2-21

NAVSUP Form 1080,7-24

NAVSUP Form 1092, 7-24

NAVSUP Form 1282, 2-14, 2-17

NAVSUP Form 1291, 13-13

NAVSUP Form 1292, 13-14

NAVSUP Form 1334, 2-19

NAVSUP Form 1336, 2-20, 2-9

NAVSUP Form 1340, 12-19, 12-20

NAVSUP Form 1343, 13-9

NAVSUP Form 1357, 3-3

NAVSUP Form 1358, 3-1

Nutrition, 7-1

 food content, 7-1

 food guide pyramid, 7-5, 7-7

 food nutrients, 7-2

 vitamins, 7-3

O

Officers' quarters afloat, 10-1

organization, 10-1

quarters, types of, 10-1

registration, 10-2

Order for Supplies or Services/Requisition for
Quotations, DD Form 1155, 12-12

P

Poultry, 6-10

preparation and cooking, 6-12

types, 6-11

Private mess afloat, records and reports, 3-3

accounting procedures, 3-6

accounting records, 3-7

billing from the general mess, 3-4

cash receipts, 3-5

commuted rations/basic allowance for subsistence,
3-5

computation of mess bills, 3-16

computational procedures for determining the cast
of subsistence in messes afloat, 3-15

credit sales, 3-12

determination of meals served, 3-15

determination of value of provisions consumed,
3-15

financial records, 3-4

inventories, 3-5

monthly financial operating statement preparation,
3-11

procurement documents, 3-4

Procurement of food items, 12-1

balanced load, 12-1

extended endurances, 12-3

operating limits, determining, 12-17

provisions requirements, determining, 12-3

purchasing, 12-10

replenishment, underway, 12-13

Procurement of food items—Continued

requisitioning food items, 12-8

stockage objectives, 12-2

Procurement publications, 12-4

R

Ration and Sales Report, NAVSUP Form 1357,
3-3

Recapitulation of Meal Record, NAVSUP Form 1292,
13-14

Receipt, 2-1

discrepancy documentation, 2-3

inspection, 2-2

posting and distribution, 2-7

unload shipment, 2-1

Record of Receipts and Expenditures, NAVSUP Form
367, 2-20, 2-10

Report of Survey, DD Form 200, 2-20

Requisition and Shipping Invoice Document, DD Form
1149, 2-17

Requisition Log, NAVSUP Form 1336, 2-20,
2-9

S

Sale of General Mess Meals, NAVSUP Form 1046,
13-21

Sanitation in food preparation, 1-4, 5-11

bacteria, 1-4

foodservice personnel, 1-4

precautions, 1-7

Sanitation of foodservice spaces, 1-15

garbage and trash disposal, 1-16

insect and rodent control, 1-16

space cleanliness, 1-16

storage areas, 1-15

Seafood, 6-14

preparation and cooking, 6-19

types, 6-14

Situational feeding, 13-3

Special meals, 12-17
 accounting procedures, 12-18
 entitlement certification, 12-17
 issue procedures, 12-17
Special Meal Request/Receipt, NAVSUP Form 340,
 12-17
Special Meals Report, NAVSUP Form 1340,
 12-19
Stateroom service afloat, 10-2
 habitability, 10-3
 stateroom care, 10-2
Storage data, 12-6
Subsistence endurance base, 12-2
Subsistence Ledger, NAVSUP Form 335, 2-8
Suggestion to Food Service Officer, NAVSUP Form
 1343, 13-9

T

Training foodservice personnel, 1-5
Transfer of food items, 2-16

U

Utensils and equipment, cleaning, 1-12

Utensils and equipment, cleaning—Continued

 hand dishwashing, 1-13
 machine dishwashing, 1-13
 removing stubborn soils, 1-12
 types of soil, 1-12

W

Wardroom mess, 9-7
 after the meal, 9-18
 beverage service, 9-13, 9-17
 buffet service, setting up, 9-13
 dining table, 9-11
 dining table center items, 9-9, 9-10
 dining table setting, 9-11
 meal service, 9-8
 meal service formal, 9-8, 9-16, 9-17
 meal service informal, 9-8, 9-15, 9-16
 meal style procedures, 9-15
 meal styles, 9-8
 seating arrangements, 9-14
 sideboard, setting up, 9-13
 special events, setting up, 9-1

Assignment Questions

Information: The text pages that you are to study are provided at the beginning of the assignment questions.

ASSIGNMENT 1

Textbook Assignment: "Sanitation," chapter 1, pages 1-1 through 1-23.

1-1. Which of the following new problems in the prevention of foodborne illness have new types of warfare presented?

1. Protection of food supplies from bacterial agents used as weapons
2. Decontamination of foods subjected to nuclear fallout
3. Decontamination of food supplies affected by chemical warfare agents
4. Each of the above

IN ANSWERING QUESTIONS 1-2 THROUGH 1-5, SELECT THE CLASSIFICATION OF FOODBORNE ILLNESS THAT MATCHES THE DESCRIPTION GIVEN AS THE QUESTION.

1-2. In this type of foodborne illness, the food in its natural state contains elements poisonous to humans.

1. Chemical food poisoning
2. Food infection
3. Natural food poisoning
4. Food intoxication

1-3. Serving lemonade that has stood in metal-plated pitchers for several hours.

1. Chemical food poisoning
2. Food infection
3. Natural food poisoning
4. Food intoxication

1-4. This type of illness is caused by poisonous toxins.

1. Chemical food poisoning
2. Food infection
3. Natural food poisoning
4. Food intoxication

1-5. This type of food illness is caused by microorganisms such as salmonella.

1. Chemical food poisoning
2. Food infection
3. Natural food poisoning
4. Food intoxication

1-6. When you are using unfamiliar foods, which of the following statements is the rule that applies?

1. Prepare according to the instructions that accompany the food item
2. Cook the food to the well-done state
3. Use a local recipe approved by the food service officer
4. Use food only if the medical officer gives approval

1-7. After silverware has been detarnished, which of the following chemical poisonings may result if improperly washed and sanitized?

1. Cyanide poisoning
2. Zinc poisoning
3. Lead and arsenic poisoning
4. Fluoride poisoning

1-8. Which of the following chemical poisonings may result from eating improperly washed raw fruits or vegetables?

1. Fluoride poisoning
2. Lead poisoning
3. Methyl chloride poisoning
4. Zinc poisoning

- 1-9. Most food poisoning is caused by bacteria called staphylococcus. This bacteria is found in which of the following areas?
1. Pimples only
 2. Pimples and nasal discharge only
 3. Pimples, nasal discharge, and throat
 4. Nasal discharge and infected cuts

IN ANSWERING QUESTIONS 1-10 THROUGH 1-13, SELECT THE ILLNESS THAT MATCHES THE DESCRIPTION GIVEN AS THE QUESTION.

- 1-10. May be present in improperly preserved canned food.
1. Trichinosis
 2. Bacillus dysentery
 3. Botulism
 4. Salmonellosis
- 1-11. The main source of this infection is personnel who do not wash their hands after leaving the head.
1. Amoebic dysentery
 2. Bacillus dysentery
 3. Botulism
 4. Salmonellosis
- 1-12. Some fresh fruits or vegetables served chilled and moist may carry this infection.
1. Amoebic dysentery
 2. Bacillus dysentery
 3. Botulism
 4. Salmonellosis
- 1-13. Most likely to occur from serving rare pork.
1. Amoebic dysentery
 2. Bacillus dysentery
 3. Trichinosis
 4. Salmonellosis

- 1-14. The greatest majority of food infection outbreaks is caused by what meat?
1. Turkey
 2. Beef
 3. Ham
 4. Lamb

- 1-15. You can best prevent a case of beef tapeworm infection from occurring in prepared beef products by following what procedure?

1. Cook the beef until well-done
2. Pickle the beef in a 25-percent salt solution for 5 days
3. Freeze the beef at 14°F or below for at least 5 days
4. Use only government-inspected beef

- 1-16. Bacteria is classified in which of the following manners?

1. By the damage they cause
2. By the symptoms they produce
3. By the number of times they multiply
4. By their shape

- 1-17. Under favorable conditions, how many bacteria will be produced by one bacterium in a 2-hour period?

1. 12
2. 18
3. 36
4. 64

- 1-18. Boiling will kill all bacteria and their toxins once they are allowed to form.

1. True
2. False

- 1-19. What temperature range will kill bacteria in the shortest time?

1. 0°F and below
2. 40°F to 140°F
3. 175°F to 180°F
4. 212°F and up

- 1-20. Which of the following carriers of bacteria is/are most likely to transmit disease to food?
1. Flies
 2. Rodents
 3. Soil
 4. Foodservice personnel
- 1-21. You must first receive a personal medical examination and sanitation training before you are permitted to work in food preparation areas.
1. True
 2. False
- 1-22. In addition to the required physical examination, all personnel must be tested for which of the following diseases?
1. Tuberculosis
 2. Hepatitis
 3. Typhoid fever
 4. Shigellosis
- 1-23. All foodservice personnel must repeat medical tests when away from work for what minimum number of days?
1. 30
 2. 45
 3. 60
 4. 75
- 1-24. In cases where environmental health officers or preventive medicine technicians are not available to perform the initial sanitation training, who may conduct the training?
1. An MS3
 2. Any corpsman
 3. Food service officer
 4. Any qualified foodservice sanitation instructor
- 1-25. When you are working in food preparation areas, you should change clothing and aprons at which of the following times?
1. At the end of the meal being prepared
 2. At the end of the day
 3. When returning from the restroom
 4. As soon as clothing or apron gets soiled
- 1-26. The use of tobacco while preparing or serving food is prohibited for which of the following reasons?
1. Smoking contaminates the fingers and hands with saliva
 2. Smoking promotes spitting and coughing
 3. Smoking is a means of transmitting disease organisms to food
 4. Each of the above
- 1-27. Which of the following offices or officials imposes public health ordinances and regulations on the military?
1. Surgeon General
 2. The U.S. Department of Agriculture
 3. The Bureau of Medicine and Surgery
 4. The National Sanitation Foundation
- 1-28. The majority of foodborne disease outbreaks are due to what total number of different factors?
1. Six
 2. Seven
 3. Three
 4. Four

- 1-29. Which of the following types of food should never be saved as leftovers?
1. Meats that are cut or sliced
 2. Unopened individual serving containers
 3. Ground or chopped foods
 4. Cooked pork products
- 1-30. The meat-cutting room should be maintained at what specific temperature?
1. 40°F
 2. 50°F
 3. 60°F
 4. 70°F
- 1-31. After what specific number of hours should protein foods that have been held at temperatures between 40°F and 140°F be considered unsafe for consumption?
1. 5
 2. 2
 3. 3
 4. 4
- 1-32. An MS keeps a leftover roast of beef on a table for 45 minutes one afternoon while cleaning the refrigerator. The MS has it out for another half hour the next day to prepare sandwiches. Exactly how much longer may the roast beef be safely kept out of the refrigerator?
1. 1 hours and 45 minutes
 2. 2 hours and 45 minutes
 3. 3 hours and 45 minutes
 4. 4 hours and 45 minutes
- 1-33. Which of the following statements concerning preparation of food is correct?
1. Hand preparation decreases the chance of contamination
 2. Hand preparation increases the length of time that foods can be held as leftovers
 3. Hand prepared protein foods can only be held as leftovers for 12 hours
 4. Hand prepared protein foods should not be used as leftovers
- 1-34. For which of the following reasons should foods that are to be refrigerated be placed in shallow pans to a depth of not more than 3 inches?
1. To make sure the pan does not spill while in chilled storage
 2. Because more than 3 inches will make the pan too heavy to carry
 3. To allow the food to cool faster
 4. Because 3 inches is the maximum allowable amount of food that you can save as leftovers
- 1-35. Leftover stew will be unsafe for use after being chilled and stored for what minimum number of hours?
1. 12
 2. 24
 3. 36
 4. 48
- 1-36. For which of the following reasons will bacteria spread rapidly through frozen meat that has been thawed?
1. Freezing hardens the tissue
 2. Freezing breaks down the tissue
 3. Freezing strengthens the bacteria
 4. Freezing dries out the tissue

1-37. Which of the following statements is correct concerning foods that are frozen and then thawed?

1. The food must be refrozen immediately
2. The food must be discarded
3. The food must be kept in covered containers at room temperature
4. The food must be stored under 40°F

1-38. Milk should be no more than what maximum temperature at the time of delivery?

1. 40°F
2. 44°F
3. 45°F
4. 50°F

1-39. Green vegetables suspected of being contaminated with pathogenic organisms should be treated in what manner?

1. Washed thoroughly under running water
2. Chemically sanitized and thoroughly rinsed
3. Broken apart and inspected for bugs
4. Cooked by boiling to kill any bacteria present

1-40. A can of molasses that bulges in tropical areas is a dangerous condition and the product should be rejected for this reason.

1. True
2. False

IN ANSWERING QUESTIONS 1-41 THROUGH 1-43, SELECT THE CAN DEFECT THAT MATCHES THE DESCRIPTION GIVEN AS THE QUESTION.

1-41. Both ends of the can bulge outward because of bacterial action and gas production. Ends do not yield to finger pressure.

1. Flipper
2. Springer
3. Pinhole
4. Sweller

1-42. One end or both ends bulge outward because of bacterial action and gas. Ends yield to finger pressure.

1. Sweller
2. Pinhole
3. Springer
4. Flipper

1-43. Both ends of the can are flat, but one end will bulge outward when the opposite end receives pressure.

1. Flipper
2. Springer
3. Pinhole
4. Sweller

IN ANSWERING QUESTIONS 1-44 THROUGH 1-48, SELECT THE TYPE OF SOIL THAT MATCHES THE DESCRIPTION GIVEN AS THE QUESTION.

1-44. The soil that remains immediately after the equipment or utensil has been used.

1. Daily deposit
2. Built-up deposit
3. Freshly deposited soil
4. Cooked deposit

1-45. The soil that remains as the result of ineffective cleaning following a flushing with water.

1. Baked deposit
2. Built-up deposit
3. Rinse deposit
4. Thin film

1-46. The result of repeated ineffective cleaning methods causing a day-by-day accumulation of soil.

1. Daily deposit
2. Built-up deposit
3. Freshly deposited soil
4. Thin film

1-47. An accumulation that results from drying action and formation of a heavy crusty deposit.

1. Baked deposit
2. Built-up deposit
3. Dried deposit
4. Heavy deposit

1-48. The result of being cooked onto equipment and having become difficult to remove.

1. Baked deposit
2. Built-up deposit
3. Cooked deposit
4. Dried deposit

1-49. All EXCEPT which of the following procedures should be followed when washing dishes and utensils?

1. Scrape food residue from all dinnerware
2. Use brushes that can be sanitized
3. Leave the dishes and utensils on the drainboard to air dry
4. Use hard abrasives to remove baked-on foods from pots and pans

IN ANSWERING QUESTION 1-50, REFER TO FIGURE 1-7.

1-50. What are the two methods of manual dishwashing?

1. The standard method and the preferred method
2. The best method and the acceptable method
3. The adopted method and the required method
4. The preferred method and the acceptable method

1-51. On spray-type dishwashing machines, water flow should not be less than how many pounds per square inch for the final rinse?

1. 10
2. 15
3. 25
4. 45

1-52. When you have a problem with insects or rodents, what is the first and most important pest control measure you should take?

1. Destroy breeding grounds
2. Set out insect and rodent traps
3. Notify the medical department
4. Install screens and seal unnecessary openings

1-53. Which of the following foodservice general cleaning methods yields the best results?

1. Clean for 2 hours at the end of each day
2. Clean up your mess as you work
3. Field day once per week
4. Field day twice per week

1-54. Radiological defense includes all such measures used to minimize personnel and material damage from radioactivity. The basic responsibility for this function belongs to what person?

1. Executive officer
2. Damage control officer
3. Food service officer
4. Medical officer

1-55. What type of radiation is considered to be the most hazardous?

1. Alpha
2. Beta
3. Gamma
4. Neutron

- 1-56. Beta particles have poor penetrating ability but their ionizing power is about 100 times that of gamma rays.
1. True
 2. False
- 1-57. When ingested with food, inhaled, or admitted into the body through cuts or open wounds, what specific type of radiation becomes particularly destructive if it is retained in the body for a lengthy time?
1. Neutron
 2. Gamma
 3. Beta
 4. Alpha
- 1-58. Radioactivity can only be removed by using what process?
1. Chemical neutralization
 2. Physical removal
 3. Sterilization
 4. Cooking
- 1-59. Contaminated food items should be monitored in their dry states because dilution with water yields what result?
1. Lowers the beta readings
 2. Raises the alpha readings
 3. Damages the radiac instruments
 4. Provides additional contamination
- 1-60. The method of gross decontamination is limited to removing radioactive material from which of the following sources?
1. Food contact surfaces
 2. The galley deck
 3. Galley personnel
 4. Canned food items
- 1-61. In what case, if any, may you use water already contaminated by radioactivity in the process of decontamination?
1. It can be used only to wash decks
 2. It can be used for all gross decontamination procedures
 3. It can be used to wash surfaces more heavily contaminated than the water
 4. None; it cannot be used for any decontamination purposes
- 1-62. Which of the following cleaning solutions may you use in radiological decontamination if you do not have a cleaning agent specifically designed for decontaminating galley surfaces?
1. Citric acid, trisodium phosphate, and hot water
 2. General-purpose detergent, trisodium phosphate, and hot water
 3. Chlorine bleach, general-purpose detergent, and hot water
 4. Vinegar, general-purpose detergent, and hot water
- 1-63. In what order should the steps used in decontaminating spaces and equipment be performed?
1. Flush with water, scrub with alkaline detergents, rinse with water, and apply acid solution
 2. Flush with water, scrub with alkaline detergents, apply acid solution, and rinse with water
 3. Apply acid solution, rinse with water, scrub with alkaline detergents, and flush with water
 4. Scrub with alkaline detergents, flush with water, apply acid solution, and rinse with water

- 1-64. Cracked and badly scratched glassware and plastic ware should be decontaminated in what manner, if any?
1. Machine washed, rinsed, dried, and each item monitored
 2. Washed with a detergent followed by an acid treatment
 3. Segregated to await natural decay of contamination
 4. None; they should be disposed of immediately
- 1-65. What may be worn in the absence of regulation masks to prevent radioactive particles from gaining entry into the body by ingestion or inhalation?
1. Chemically treated layers of gauze covering the nose and mouth
 2. A filter improvised from wet towels treated with an acid solution
 3. An improvised face shield covered with aluminum foil to reflect radiation
 4. A particulate air filtering respirator
- 1-66. In what manner should you identify an area that has been recontaminated?
1. Draw a chalk line around it
 2. Cover it with canvas
 3. Paint it purple
 4. Rope it off
- 1-67. Weapons of biological agents differ from conventional weapons in that biological weapons act in which of the following ways?
1. Work only in hot climates
 2. Do not work on ships
 3. Are often targeted for small groups
 4. Damage only plants, animals, and people
- 1-68. Which of the following statements pertaining to biological agents is NOT correct?
1. Biological agents destroy both living matter and inorganic matter
 2. Good sanitary and hygienic practices do not defend against biological warfare
 3. Sickness could be caused by contamination that occurred weeks before
 4. Hardier organisms are present in higher levels of contamination
- 1-69. Because of the current difficulties in rapidly detecting biological agents, an incident of biological contamination may likely be detected in what way?
1. Use of radiation monitoring equipment
 2. Knowledge of an impending biological assault
 3. The occurrence of widespread or unusual sickness
 4. The absence of plants and animals
- 1-70. What chemical solution should be used for biological decontamination?
1. Citric acid and water solution
 2. Trisodium phosphate, general-purpose detergent, and water solution
 3. Calcium hypochlorite (bleach) solutions
 4. Lime solutions prepared by the medical department

- 1-71. Which of the following statements is NOT correct regarding secondary aerosols?
1. They may cause recontamination
 2. They are clouds formed from particles (bacteria or other organisms)
 3. They may be suppressed by wetting surfaces with oil or water
 4. They do not recontaminate the air that is breathed
- 1-72. If available, what should you use for the biological decontamination of food packed in impermeable packages?
1. Sodium carbonate
 2. Vinegar
 3. Citric acid
 4. Sodium phosphate
- 1-73. In an emergency when no regular water treatment facilities are available, which of the following methods should be used to render the water supply safe for drinking?
1. Adding ethylene oxide
 2. Boiling the water for 20 minutes or longer
 3. Adding laundry bleach
 4. Filtering the water through wood ashes
- 1-74. Metal and china utensils that have been exposed to light liquid contamination should be immersed in actively boiling water containing an alkaline detergent for what specific number of minutes?
1. 5
 2. 10
 3. 20
 4. 30

ASSIGNMENT 2

Textbook Assignment: Receipt, Inspection, Expenditure, and Storage of Food Items, chapter 2, pages 2-1 through 2-22; and "Accounting," chapter 3, pages 3-1 through 3-17.

- 2-1. When food items are received from commercial sources, what person must sign a statement on the invoice that reads "I accept responsibility for these items and hold myself accountable to the United States Government?"
1. Commanding officer of the receiving activity
 2. Food service officer of the receiving activity
 3. Mess treasurer, having made payment of received food items
 4. Bulk storeroom storekeeper having custody of food items delivered
- 2-2. Under normal conditions, subsistence items received from commercial vendors are inspected at which of the following points?
1. Origin only
 2. Destination only
 3. Origin and destination only
 4. Origin, DPSC supply point, and destination
- 2-3. When food items are received from commercial sources, the supply officer should make sure the vendors are in conformance with the requirements originating from what source?
1. Department of Defense Food Cost Index
 2. Federal Food, Drug, and Cosmetic Act
 3. NAVSUP P-4998
 4. NAVMEDCOMINST 5360.1
- 2-4. Meat, poultry, fish, and their by-products delivered under contract within the United States should be accepted only under what condition?
1. Are received in a frozen state
 2. Are from freshly butchered animals
 3. Bear the appropriate stamps from the respective government agencies
 4. Pass a fitness-for-human-consumption inspection upon receipt
- 2-5. In what manner should food items be classified that do not meet expected or desired standards, but do not constitute a health hazard to personnel if consumed?
1. Satisfactory nonhazardous food items
 2. Satisfactory hazardous food items
 3. Unsatisfactory hazardous food items
 4. Unsatisfactory nonhazardous food items
- 2-6. An example of a nonhazardous food item received under unsatisfactory conditions is described by which of the following cases?
1. Chicken wings in a box labeled breasts
 2. Ice cream received on a hot day
 3. Fresh fish packed in ice
 4. A case of jarred pickles with loose lids and seepage

- 2-7. What publication describes the procedures regarding the reporting and handling of nonhazardous and hazardous food items?
1. NAVSUP P-476
 2. NAVSUP P-486, volume I
 3. NAVSUP P-486, volume II
 4. NAVSUP P-580
- 2-8. When reporting a shortage in shipment due to transportation discrepancies, you should refer to what source?
1. NAVSUPINST 4061.8
 2. NAVSUPINST 4061.11
 3. NAVSUPINST 4440.179
 4. NAVSUPINST 4610.33
- 2-9. When a nonsubstantial shortage in shipment of food items occurs, which of the following actions should be performed?
1. Refuse receipt of food items being delivered
 2. Document the actual quantity physically received
 3. Survey the quantity that the shortage represents
 4. Absorb the shortage as part of the stores consumed
- 2-10. When an overage in shipment occurs from a commercial vendor, you should take which of the following actions?
1. Record the actual quantity received on all applicable documents
 2. Record only the requested quantity but accept all items
 3. Prepare a dummy invoice to reflect the actual amount received
 4. Return any excess quantities to the vendor
- 2-11. When you are posting receipts, which of the following pieces of information must be transcribed to the GM records?
1. Date and value of receipt
 2. Source and quantity of receipt
 3. Source and date of receipt
 4. Value and quantity of receipt
- 2-12. The total dollar money value of each receipt document is posted to what GM record?
1. NAVSUP Form 209
 2. NAVSUP Form 335
 3. NAVSUP Form 367
 4. NAVSUP Form 1046
- 2-13. What dollar value does the first entry on the NAVSUP Form 367 represent?
1. Outstanding requisitions
 2. Total of previous quarters' receipts
 3. Total of initial receipts for the period
 4. Inventory carried forward
- 2-14. Which of the following prices should you use to survey, transfer, or sell food items to private messes?
1. The price established by NAVFSSO quarterly
 2. The item price at the time of receipt
 3. The item price plus the applicable surcharge
 4. The price representing the current market value
- 2-15. What form is used to document food items received during an underway replenishment?
1. DD Form 1149
 2. DD Form 1348-1
 3. NAVSUP Form 1059
 4. NAVSUP Form 1282

- 2-16. What form is used to purchase food items from commercial sources?
1. DD Form 1348m
 2. DD Form 1348-1
 3. DD Form 1155
 4. DD Form 1149
- 2-17. Upon receipt of material from a commercial vendor, the inspector should remove what minimum number of copies of the DD Form 1155 from the outstanding purchase order file for receipt documentation?
1. One
 2. Two
 3. Three
 4. Four
- 2-18. When orders are placed for delivery of an item over an extended period, the amount of the delivery is noted on the DD Form 1155 at what time?
1. When the orders are placed
 2. When each order is received
 3. At the end of the week
 4. At the end of the month
- 2-19. What storage principle is used when you place items that are issued most frequently nearest to the breakout area?
1. Orderliness
 2. Accessibility
 3. Cleanliness
 4. Safety
- 2-20. When placing case goods in the storage area so that they can be counted by sight without being moved, you are using what storage principle?
1. Safety
 2. Accessibility
 3. Orderliness
 4. Size
- 2-21. Under normal conditions, you should store semiperishable food items in what manner?
1. In a chill box
 2. In a nonrefrigerated space
 3. In a clean, warm, well-ventilated space
 4. In a clean, cool, nonventilated space
- 2-22. You should base the length of storage for your semiperishable food items upon what factor?
1. The moisture content of the product
 2. The percent of humidity in the storage space
 3. The actual date of receipt of the product
 4. The packing date of the product
- 2-23. At what time may you issue new stock when older stock is still present?
1. When issuing food items to a private mess
 2. When transferring food items to another activity
 3. When preparing for a holiday or special meal
 4. When newer stock shows signs of deterioration or spoilage
- 2-24. What immediate action should you take with food items that have been stored beyond the safe storage limit?
1. Conduct an investigation to determine the cause
 2. Inspect for spoilage, leakage, or other damage
 3. Promptly issue for use
 4. Survey and expend from the records

- 2-25. Food items with an average keeping time of 90 days are stored in a space with the storage temperature maintained at 90°F. What is the resulting keeping time of the food items stored in this space?
1. 45 days
 2. 50 days
 3. 65 days
 4. 70 days
- 2-26. Food items with an average keeping time of 90 days stored at 40°F will have what keeping time?
1. 90 days
 2. 120 days
 3. 180 days
 4. 200 days
- 2-27. When storing fresh fruits and vegetables, you should allow what minimum clearance between the tops of stacks and the openings of air ducts to permit air circulation?
1. 6 inches
 2. 8 inches
 3. 12 inches
 4. 24 inches
- 2-28. When you store fresh fruits and vegetables in a tight compartment at temperatures of 40°F or higher, the concentration of the carbon dioxide produced by respiration may reach a level in which it is unsafe to work.
1. True
 2. False
- 2-29. When you store cases of frozen meats in refrigerated spaces, you should stack them on pallets at least how many inches from the bulkhead or refrigerator coils?
1. 10
 2. 8
 3. 6
 4. 4
- 2-30. Upon receipt of frozen fruit and vegetables, you should take the temperatures of select cartons. What should you do if the temperatures taken are higher than that of the frozen storage space?
1. Refuse receipt of the frozen product
 2. Immediately issue to the galley for use
 3. Scatter the shipping cases loosely about the deck of the freezer
 4. Store items to the back of the freezer near fans
- 2-31. Which of the following statements is NOT correct regarding breaking out frozen food items from refrigerated spaces?
1. Breakouts should be planned for a full day's requirements
 2. All items should be stored temporarily in the chill box if not intended for immediate use
 3. All messes must draw their frozen subsistence items at different times
 4. All messes must draw their frozen subsistence items at a predetermined time
- 2-32. When you load frozen stores, the higher temperature of the food being stored will cause a rise in temperature in the refrigerated space. What should your resulting actions be as the person in charge of this space?
1. Conduct only emergency breakouts until the temperature returns to normal
 2. Place bags of ice in the freezer to help lower temperature
 3. Leave the box closed until the normal temperature level has been reached
 4. Increase the flow of freon to the refrigerated unit

- 2-33. Who should you notify first if a refrigerated unit malfunctions?
1. Duty engineer
 2. Duty supply petty officer
 3. Galley watch captain
 4. Supply officer
- 2-34. Which of the following persons is required to maintain a refrigerator log?
1. An engineering department representative
 2. Each person responsible for maintaining a refrigerated space
 3. The leading MS
 4. Each of the above
- 2-35. Refrigerator temperature log readings are required to be taken at what frequency?
1. Once daily
 2. Every 2 hours
 3. Twice daily
 4. Every 4 hours
- 2-36. Issues of food items from the bulk storeroom, issue room, or combined bulk and issue storerooms are made on either a NAVSUP Form 1059 or a NAVSUP Form 1282.
1. True
 2. False
- 2-37. You are required to prepare issue documents in what manner?
1. Original only
 2. Original and one copy only
 3. Original and two copies only
 4. Original and three copies
- 2-38. What type of inventory involves frequent counting of a small number of fast-moving, high-cost items?
1. Optional
 2. Accountability
 3. Physical
 4. Spot
- 2-39. What persons or organization determines the extent and complexity to which the financial records are maintained in private messes afloat?
1. Supply officer and leading MS
 2. Commanding officer and mess treasurer
 3. The Defense Finance Accounting Service
 4. The Navy Food Service Systems Office
- 2-40. Private mess financial records should be retained for what specific time period?
1. 1 year
 2. 2 years
 3. 3 years
 4. Until after the next audit
- 2-41. All documents that authorize purchases to be paid with mess funds must be signed by what person?
1. Mess president
 2. Supply officer
 3. Disbursing officer
 4. Mess treasurer
- 2-42. Which of the following forms is used by a private mess to purchase food items from approved commercial sources?
1. DD Form 1149
 2. DD Form 1155
 3. NAVCOMPT Form 2213
 4. NAVCOMPT Form 2227
- 2-43. The food service officer should prepare a bill for the amount due for food items issued to a private mess during the previous month at no later than what maximum number of days into the next month?
1. 1
 2. 5
 3. 10
 4. 15

- 2-44. When payment is made for items purchased from the GM, the mess treasurer should obtain a signature from the food service officer on what form?
1. NAVSUP Form 338
 2. NAVSUP Form 340
 3. NAVSUP Form 470
 4. NAVSUP Form 1046
- 2-45. What person is responsible for submitting a monthly list of enlisted personnel subsisting in a private mess to the disbursing officer?
1. Executive officer
 2. Food service officer
 3. Mess treasurer
 4. Leading MS
- 2-46. Payment of meals consumed by enlisted personnel assigned to a private mess is made using what document?
1. Cash Receipt Book
 2. Pay Receipt
 3. Public Voucher
 4. A locally prepared form
- 2-47. For which of the following reasons are rations commuted to a private mess?
1. To compensate for the limited private mess funds
 2. To support the members' mess bills
 3. To increase the value of mess shares
 4. To subsist the enlisted personnel
- 2-48. What person or organization establishes the maximum amount of cash funds a mess treasurer is authorized to have on hand?
1. Disbursing officer
 2. Commanding officer
 3. The Defense Finance Accounting Service
 4. The Navy Food Service Systems Office
- 2-49. When there is more than one private mess aboard a command, a joint bank account may be opened for their mess funds.
1. True
 2. False
- 2-50. The rules concerning the control of safe combinations should be found in what reference?
1. SECNAVINST 5212.5
 2. NAVSUP P-486, volume II
 3. NAVSUP P-421
 4. NAVCOMPT Manual, volume 4
- 2-51. At which of the following times must the combination be changed to the safe that is provided to the person responsible for mess funds?
1. Upon the relief of the supply officer or quarterly
 2. Upon the relief of the mess president or every 6 months
 3. Every 6 months or whenever a new custodian takes over
 4. Every quarter or whenever a new custodian takes over

- 2-52. In the absence of the private mess storeroom custodian, emergency entrance into storerooms and other secured spaces may be accomplished in only what manner?
1. Opened by the mess caterer in the presence of the mess treasurer
 2. Opened by the supply officer in the presence of the mess treasurer
 3. Opened by the mess president in the presence of two witnesses
 4. Opened by the mess treasurer in the presence of two witnesses
- 2-53. An inventory of all provisions procured with private mess funds should be conducted at what specific time intervals?
1. Monthly
 2. Quarterly
 3. Semiannually
 4. Annually
- 2-54. What persons are responsible for conducting inventories of private mess provisions?
1. The food service officer and provisions storeroom custodian
 2. The supply officer and provisions storeroom custodian
 3. The mess treasurer and one member of the audit board
 4. The leading mess petty officer and one member of the audit board
- 2-55. The duplicate copy of the inventory conducted on food items procured with private mess funds is retained by what individual?
1. Mess treasurer
 2. Mess president
 3. Food service officer
 4. Senior audit board member
- 2-56. The first entry on the record of collections represents the dollar value of what item?
1. Inventory brought forward from the preceding month
 2. Cash balance carried forward from the preceding month
 3. Commuted rations received for the current month
 4. Net worth of the mess
- 2-57. The treasurer must submit a statement of accounts to what person at the end of the month?
1. Disbursing officer
 2. Mess president
 3. Supply officer
 4. Commanding officer
- 2-58. What publication prescribes general financial management policies and principles governing the management of private messes afloat?
1. NAVSO P-3520
 2. NAVSUP P-486, volume II
 3. *Navy Regulations*
 4. *Navy Comptroller Manual*, volume 4
- 2-59. Money owed to the mess and money owed by the mess are recorded on which of the following forms?
1. Record of expenditures only
 2. Record of collections only
 3. Records of collections and expenditures
 4. Records of accounts payable and receivable
- 2-60. Which of the following pieces of information is recorded on the record of mess members?
1. The amount each member paid for membership
 2. The value of each member's current mess share
 3. The value of each member's projected mess share
 4. Additional charges to members having guests

- 2-61. Which of the following transactions is NOT recorded on the accounts payable record sheet?
1. Rebates due to mess members
 2. Charges for provisions from the GM
 3. Rations commuted to the mess
 4. Costs of commercially procured provisions owed
- 2-62. Before a private mess can establish a petty cash fund, authorization must first be obtained from what source?
1. Navy Food Service Systems Office
 2. Navy Regional Finance Center
 3. Commanding officer
 4. Disbursing officer
- 2-63. For what condition is the use of a cost control record optional in a private mess?
1. At the commanding officer's discretion
 2. At the mess treasurer's discretion
 3. When the mess has less than 20 members
 4. When the disbursing officer is also the mess treasurer
- 2-64. The Meals Served Record Sheet reflects a monthly summary of all meals consumed in the private mess. What document is used to substantiate this summary?
1. The Food Cost Control Record
 2. The Monthly Financial Operating Statement for Messes Afloat
 3. The NAVSUP Form 1046
 4. The NAVSUP Form 1357
- 2-65. Who is responsible for maintaining the NAVSUP Form 1046 for meals sold from a GM to a private mess?
1. A designated GM MS
 2. The messdeck master-at-arms
 3. The records keeper
 4. The mess treasurer
- To answer questions 2-66 through 2-68, consider the following information. For a given month, the total number of meals consumed in a private mess totaled 1,437. Mess members and their guests consumed 874 meals. Enlisted personnel consumed 563 meals. The total value of provisions consumed in this mess was \$1,863.77. The value of commuted rations totaled \$936.00.
- 2-66. What is the value of the meals consumed by the enlisted personnel?
1. \$594.54
 2. \$631.81
 3. \$711.96
 4. \$730.60
- 2-67. What dollar value of rations commuted must be credited to the Operation and Maintenance, Navy (O&M,N) fund code?
1. \$205.40
 2. \$224.04
 3. \$304.19
 4. \$341.46
- 2-68. What percentage of the meals were consumed by enlisted personnel?
1. 31.9%
 2. 33.9%
 3. 38.2%
 4. 39.2%
- 2-69. Which of the following results will you obtain by subtracting the money value of the closing inventory from the sum of the opening inventory plus the total receipts during the month?
1. The total dollar value of outstanding receipts
 2. The total dollar value of all expenditures
 3. The total value of provisions consumed
 4. The worth of the mess share

- 2-70. If the beginning inventory was \$580.36, total receipts are \$789.53, and the closing inventory is \$475.87, then what is the cost of the food consumed?
1. \$266.70
 2. \$684.02
 3. \$685.04
 4. \$894.02
- 2-71. If for a given month, the average number of officers that subsisted is 29.80 and the average number of enlisted personnel that subsisted is 8.66, and the cost of provisions consumed is \$2,706.93, then what is the cost per person?
1. \$70.38
 - 2* \$71.24
 3. \$73.14
 4. \$73.16
- 2-72. A mess member reports for duty at 0900 on 14 November. The mess bill for November is \$62.00. What will this member's bill be for the month of November?
1. \$29.03
 2. \$29.03 plus December's mess share
 3. \$35.13
 4. \$35.13 plus December's mess share
- 2-73. A mess member is being permanently detached at 1200 on 21 March. The mess bill for March is \$55.00, which the mess member paid on 28 February. What is the rebate due this member?
1. \$12.60
 2. \$15.97
 3. \$17.74
 4. \$19.52
- 2-74. A mess member goes TAD at 0800 on 7 July to 1630 on 15 July. The mess bill for July is \$66.00, which the member paid on 30 June. What is the rebate due this member?
1. \$14.90
 2. \$17.00
 3. \$17.03
 4. \$19.16
- 2-75. A mess member is on leave from 0001 on 20 September to 0730 on 5 October. The mess bill for September is \$51.00, which the member paid on 30 August. The mess bill for October is \$48.00. What is the member's net mess bill owed for the month of October minus his or her rebate?
1. \$18.70
 2. \$23.11
 3. \$24.59
 4. \$48.00

ASSIGNMENT 3

Textbook Assignment: "Foodservice Equipment," chapter 4, pages 4-1 through 4-28.

- 3-1. You should observe which of the following general precautions before attempting to operate any foodservice equipment?
1. Know the telephone numbers and methods of reporting emergencies
 2. Know the location of all safety and emergency switches
 3. Determine the location of the fire extinguishers
 4. Each of the above
- 3-2. As a general precaution, how should nonessential equipment operation be handled in the event of continuous ship movement?
1. Caution should be exercised during operation
 2. Rings and watches should be removed and any loose clothing eliminated
 3. Equipment should only be operated if it is permanently mounted
 4. Machine operation should be discontinued and equipment turned off
- 3-3. You are required to perform which of the following tasks before any major cleaning evolution involving electrical equipment?
1. Tag-out the equipment according to the tag-out bill
 2. Notify the medical department so that they can supervise the evolution
 3. Notify your supervisor of the scheduled evolution
 4. Attend safety training provided by the ship's safety officer
- 3-4. Undue health hazards may be avoided when using foodservice equipment by carrying out which of the following measures?
1. Follow correct operating procedures
 2. Adhere to proper cleaning schedules
 3. Give equipment adequate preventive maintenance
 4. Each of the above
- 3-5. You should use what type of water to recharge the vacuum system of the electrical steam-jacked kettle?
1. Mineral
 2. Regular tap
 3. Distilled
 4. Condensed
- 3-6. The size of steam-jacketed kettles varies over what specific gallon capacity range?
1. 4 to 45
 2. 4 to 80
 3. 5 to 45
 4. 5 to 80
- 3-7. When you are operating a steam-jacketed kettle, which of the following actions can have dangerous consequences?
1. Filling the kettle three-fourths full
 2. Closing the safety valve when you are turning on the steam
 3. Cleaning the kettle with boiling water
 4. Using the faucet at the bottom of the kettle to remove gravies or sauces

- 3-8. The safety valve on the steam-jacketed kettle is installed to accomplish what purpose?
1. Add more heat to the kettle during cooking
 2. Remove residual water from the steam within the kettle
 3. Prevent the kettle from overheating
 4. Keep the kettle from exploding by releasing excess steam pressure
- 3-9. What does the signal light that is provided for each thermostat on the electric griddle indicate when it flashes on and off?
1. The grill is still warming up and has not reached the desired temperature
 2. The grill is maintaining the correct temperature while in use
 3. The grill is overheating and should be turned down or off
 4. The grill has just warmed beyond the preset temperature
- 3-10. Before starting griddle cleaning procedures, you must perform which of the following preparation tasks?
1. Use a cellulose sponge to dry up any liquid
 2. Remove grease traps and empty any grease
 3. Get a container of hot soapy water for cleaning
 4. Secure electrical power at the main source of power
- 3-11. After the grill has been thoroughly cleaned, you must preheat it to 400°F. Once this temperature is reached you should spread a light film of cooking oil over the surface of the grill. You should then wait 2 minutes, wipe the surface clean of excess oil, then repeat. What is this procedure called?
1. Blueing
 2. Browning
 3. Seasoning
 4. Glazing
- 3-12. The tilting skillet has a secondary thermostat that acts as a high-limit cutoff. It disables the power circuit when the temperature exceeds what level?
1. 400°F
 2. 425°F
 3. 450°F
 4. 460°F
- 3-13. What does the size of a deep-fat fryer indicate?
1. The number of pounds of french-fried potatoes that can be prepared per minute
 2. The number of pounds of french-fried potatoes that can be prepared per hour
 3. The number of pounds of french-fried potatoes that can be prepared in 5 minutes
 4. The total number of french-fried potatoes that can be prepared at one time

- 3-14. When it is necessary to melt solid fat in the deep-fat fryer, you should follow which of the following procedures?
1. Set the thermostat at the temperature prescribed in the *Armed forces Recipe Service*
 2. Check the temperature of the fat frequently during the melting process with a hand thermometer
 3. Make sure the fat covers the uppermost coil at all times and the temperature is no more than 200°F while the fat is melting
 4. Have a person standing by with a PKP extinguisher
- 3-15. The temperature of a deep-fat fryer should never exceed what maximum level?
1. 380°F
 2. 400°F
 3. 425°F
 4. 450°F
- 3-16. Frying foods containing excess moisture in a deep-fat fryer will produce which of the following results?
1. Cause the grease to overheat
 2. Cause the grease to smoke heavily
 3. Cause the grease to boil over
 4. Cause the grease to become rancid
- 3-17. How should you extinguish a fire in the deep-fat fryer when the automatic fire extinguisher fails to set off automatically or manually?
1. Use water
 2. Smother the fire with the deep-fat fryer cover
 3. Use a CO extinguisher
 4. Use a PKP extinguisher
- 3-18. Which of the following statements is NOT correct regarding the operation of convection ovens?
1. Overall, cooking temperatures are higher than in conventional ovens
 2. The amount loaded into the oven at one time will influence the cooking time
 3. A blower fan circulates hot air throughout the oven, eliminating cold spots
 4. Overall, cooking time is shorter than in conventional ovens
- 3-19. Which of the following actions is the major cause of nonuniform baking and roasting?
1. Opening the oven door too frequently
 2. Overloading the oven
 3. Improper placement of food in the oven
 4. An insufficient preheat period
- 3-20. When baking, you should determine the desired cooking times in both convection and conventional ovens by using which of the following resources?
1. The AFRS
 2. Oven manufacturer's operating manual
 3. A thermometer
 4. Visual examination
- 3-21. What cleaning agent should you use to clean Teflon oven panels?
1. Oven cleaner
 2. Scouring powder
 3. Concentrated lemon juice
 4. Hot sudsy water

IN ANSWERING QUESTIONS 3-22 THROUGH 3-25, SELECT FROM COLUMN B THE TYPE OF ELECTRIC RANGE THAT MATCHES THE DESCRIPTION IN COLUMN A.

	<u>A. FEATURES</u>	<u>B. TYPES</u>
3-22.	Griddle on left side, hot plate on right, and a two-compartment oven	1. S 2. C 3. F
3-23.	A compact galley range found on board submarines	
3-24.	Single griddle on top and a single oven	
3-25.	Griddle on left side, hot plate on right, and a single oven	
<hr/>		
3-26.	Which of the following attachments for the electric food mixer should you use for lightweight mixing?	
		1. Wire whip 2. Flat beater 3. Churn paddle 4. Dough hook
3-27.	When mixing ingredients, you should never fill the mixing bowl beyond what level?	
		1. 3/8 full 2. 1/2 full 3. 2/3 full 4. 3/4 full

- 3-28. The wheel crank control on a large electric mixer controls what mixer function?
1. The tightening of the beater in the beater shaft
 2. The speed of the mixer
 3. The lowering of the beater to the proper position for beating
 4. The raising of the mixing bowl to the proper position for beating
- 3-29. When you mix ingredients too long after they are already properly blended, you risk obtaining what result?
1. Excessive moisture due to the breakdown of the ingredients
 2. A higher finished temperature than the desired temperature
 3. Blended ingredients becoming separated
 4. Excessive heat from mixing that reduces the moisture content of the blended ingredients
- 3-30. Which of the following procedures should you perform first when operating the automatic feed meat-slicing machine?
1. Set the dial for the desired thickness
 2. Set the machine on automatic
 3. Place the meat in the carriage and adjust the clamp
 4. Turn on the power to the machine
- 3-31. All EXCEPT which of the following statements describe a safety feature of the meat-slicing machine?
1. It is hard wired
 2. It has a backup electric switch
 3. It has a revolving disk knife
 4. It should not be operated without the blade guard

- 3-32. When the steam supply to the steamer in your galley is controlled separately, in what manner should you turn on the steam?
1. By opening the exhaust valve only
 2. By closing the compartment door and opening the exhaust valve
 3. By slowly turning the valve wheel counterclockwise
 4. By closing the steamer compartment door securely
- 3-33. The steam in a steamer at 7 pounds per square inch will reach what maximum temperature?
1. 211°F
 2. 222°F
 3. 233°F
 4. 244°F
- 3-34. If there is no safety valve to relieve steam pressure after cooking has been completed, what procedure should you follow before opening the steamer door?
1. Wait until the pressure gauge reads 2 pounds per square inch
 2. Wait until no condensate appears in the drainpipe
 3. Unlatch the door and wait 1 minute
 4. Wait 2 minutes before opening the door
- 3-35. When you examine the drainpipe for steam-condensate drip after a few minutes of steamer operation and none appears, which of the following conditions will NOT be the cause?
1. There is stoppage in the trap
 2. There is stoppage in the strainer
 3. There is stoppage in the drainpipe
 4. There is stoppage in the steam gauge
- 3-36. How often should the steamer be scrubbed clean and rinsed with hot water at 170°F?
1. After each meal
 2. Twice daily
 3. Once a week
 4. Every evening
- 3-37. Filters for the filter-type ventilator hood must be cleaned at what minimum frequency?
1. Once a day
 2. Once a week
 3. Twice a week
 4. Once a month
- 3-38. What is the main function of the Gaylord ventilator hood?
1. To supply fresh air
 2. To extract grease from the air
 3. To cool the area
 4. To filter fumes from the air
- 3-39. In later model ventilator hoods equipped with automatic cleaning capabilities, the thermostat switch located in the exhaust ductwork operates a magnetic trip inside the fire damper control box when the temperature reaches 250°F. When this occurs, what will the resulting actions be?
1. The fire damper slams shut and the blower shuts down only
 2. The fire damper slams shut and PKP is released only
 3. The fire damper slams shut, the blower shuts down, and PKP is released
 4. The fire damper slams shut, the blower shuts down, and water is released

- 3-40. Which of the following sources provide(s) engineering personnel with complete technical information on airflow, electrical characteristics, and other data of primary use concerning ventilator hoods?
1. Material safety data sheets (MSDSs)
 2. Planned maintenance system (PMS) cards
 3. *NAVSEA Technical Manual*
 4. *Shipboard Foodservice Equipment Catalog*
- 3-41. You should use a dough trough to perform what purpose?
1. To mix dough
 2. To knead dough
 3. To ferment dough
 4. To proof dough
- 3-42. Dough troughs are of various lengths and are designed to hold approximately how many pounds of dough per foot of space?
1. 50
 2. 70
 3. 90
 4. 100
- 3-43. How much time is required for a dough proofer to attain the proper atmosphere for proofing?
1. 15 minutes
 2. 30 minutes
 3. 45 minutes
 4. 60 minutes
- 3-44. Steam pressure passing through the steam coils of the proofer should never be allowed to exceed what maximum pounds per square inch?
1. 15
 2. 25
 3. 35
 4. 45
- 3-45. For what reason is the platform on the bread slicer where the bread is placed angled at 45 degrees?
1. So that bread will not be torn while being sliced
 2. To guard your fingers from the blades
 3. To allow half of the blades to go in the opposite direction
 4. To force the bread down on the cutting blade
- 3-46. The quantity of vegetables loaded into the vegetable peeler should not exceed what percentage of the total hopper capacity?
1. 44
 2. 55
 3. 66
 4. 77
- 3-47. If the abrasive surfaces of the vegetable peeler are kept reasonably clean, a load of vegetables should be satisfactorily peeled in what approximate time?
1. 1 minute
 2. 2 minutes
 3. 30 seconds
 4. 45 seconds

IN ANSWERING QUESTIONS 3-48 THROUGH 3-56,
SELECT THE TYPE OF MACHINE THAT MATCHES
THE DESCRIPTION GIVEN AS THE QUESTION.

- 3-48. The disk has a wavy surface that agitates the vegetables in such a manner that they continually present new surfaces for action by the abrasive material.
1. Vegetable peeler
 2. Vegetable cutter
 3. Vegetable cutter and slicer
 4. Vegetable shaper
- 3-49. Makes three classes of cuts of vegetables—shredded, sliced, and grated--without the use of attachments or removable parts.
1. Vegetable shaper
 2. Vegetable cutter
 3. Vegetable cutter and slicer
 4. Vegetable peeler
- 3-50. The machine may be used to do as many as three different cutting jobs at once.
1. Vegetable shaper
 2. Vegetable cutter
 3. Vegetable cutter and slicer
 4. Vegetable peeler
- 3-51. The machine may be used to cut french fries.
1. Vegetable shaper
 2. Vegetable cutter
 3. Vegetable cutter and slicer
 4. Vegetable peeler
- 3-52. The machine has parts that should be oiled daily to prolong its life and efficiency.
1. Vegetable shaper
 2. Vegetable peeler
 3. Vegetable cutter
 4. Vegetable cutter and slicer
- 3-53. Has seven safety precautions that you must follow when operating.
1. Meat saw
 2. Meat chopper
 3. Meat slicer
 4. Meat tenderizer
- 3-54. Must wash and sanitize this machine properly after every 4 hours of continued use.
1. Meat saw
 2. Meat chopper
 3. Meat slicer
 4. Meat tenderizer
- 3-55. This machine is portable and is used to grind meats.
1. Meat saw
 2. Meat chopper
 3. Meat slicer
 4. Meat tenderizer
- 3-56. Is equipped with a safety device that automatically stops the machine when the cover (shield) is raised.
1. Meat saw
 2. Meat chopper
 3. Meat slicer
 4. Meat tenderizer
- 3-57. For which of the following meat-cutting jobs should you use a knife having a long, wide blade?
1. Boning beef
 2. Slicing raw steak
 3. Carving cooked roasts
 4. Slicing bread

- 3-58. You should use the butcher's steel to accomplish which of the following tasks?
1. To sharpen knives
 2. To keep the edges of knives straight
 3. To remove chips in knives by evening the flat surface of the blade
 4. To keep the blade surface wearing uniform
- 3-59. You must maintain the wash water in single-tank dishwashing machines within what specific temperature range?
1. 95°F to 125°F
 2. 110°F to 125°F
 3. 130°F to 140°F
 4. 140°F to 160°F
- 3-60. For a double-tank dishwashing machine, what are the minimum (a) wash and (b) rinse time intervals?
1. (a) 20 seconds: (b) 10 seconds
 2. (a) 20 seconds: (b) 20 seconds
 3. (a) 40 seconds: (b) 10 seconds
 4. (a) 40 seconds: (b) 20 seconds
- 3-61. What operating feature(s) other than an extra tank is/are added to a triple-tank dishwashing machine to differentiate its capabilities from those of a double-tank machine?
1. A prewash feature
 2. Different temperature requirements for the wash and rinse cycles
 3. Both 1 and 2 above
 4. Different temperature requirements for the sanitizing cycle
- 3-62. The majority of dishwashing machines in service in the Navy are what type?
1. Single-tank
 2. Double-tank
 3. Triple-tank
 4. Manual, three-sinks
- 3-63. You should inspect the interior of the dishwashing machine and the manifold(s) for accumulation of calcium or lime deposits at what specific time intervals?
1. Semiweekly
 2. Weekly
 3. Monthly
 4. Quarterly
- 3-64. Steam tables most commonly found in most general and private messes today are what type?
1. Those with water compartments heated by steam coils at 40 pounds of pressure or less
 2. Those with steam-heated water compartments and dish warmers
 3. Those with water compartments heated by immersion-electric heating elements
 4. Those with water compartments and dish warmers
- 3-65. For what reason should the water temperature in the steam table not exceed 200°F?
1. The steam table compartments will warp
 2. The steam table will shut down from overheating
 3. The food in the steam table will continue to cook
 4. Water will be added automatically to lower the temperature
- 3-66. Potato shapers are used to accomplish which of the following tasks?
1. To make french fries from whole potatoes
 2. To make hashbrowns from whole potatoes
 3. To make potato balls from whole potatoes
 4. To reconstitute dehydrated potatoes into formed french fries

- 3-67. To keep a refrigerator operating at maximum efficiency, you must observe which of the following rules?
1. Keep it clean
 2. Do not overload it
 3. Defrost it regularly and properly
 4. Each of the above
- 3-68. You are required to defrost the refrigerator at which of the following times?
1. Before receiving a major breakout
 2. When you notice a bad odor
 3. When ice formation reaches three-sixteenths of an inch thick
 4. When ice formation reaches one-fourth of an inch thick
- 3-69. Select the acceptable method for speeding up the process of defrosting the refrigerator.
1. Applying hot water to the coils using a hose
 2. Applying heat to the coils using an electric heat gun
 3. Pouring hot water on the cooling unit
 4. Placing pans of hot water in the freezer
- 3-70. What is the specific holding temperature range for the refrigerated milk dispenser?
1. 38°F to 44°F
 2. 36°F to 45°F
 3. 32°F to 45°F
 4. 32°F to 40°F
- 3-71. You should sanitize the soft-service ice-cream machine at what specific time(s)?
1. After each use only
 2. After each use and at the end of the day
 3. Before and after each use
 4. Each day
- 3-72. You should remove the automatic twin coffee urn brew basket containing spent coffee grounds what number of minutes after brewing?
1. 60
 2. 30
 3. 3
 4. 5
- 3-73. After a night or weekend shutdown, the proper brewing temperature in the automatic twin coffee urn requires what specific number of minutes to be obtained?
1. 30
 2. 45
 3. 50
 4. 55
- 3-74. Which of the following methods should you use to aid in chilling beverages served from a noncarbonated beverage dispenser?
1. Add ice to chill the beverage at the time of preparation
 2. Add ice to the beverage as it is being dispensed
 3. Prepare the beverage in advance and prechill
 4. Turn on the refrigerated beverage dispenser 1 hour before adding the beverage
- 3-75. You should take which of the following measures regarding the operation of the bulk ice-making machine?
1. Allow only authorized personnel access to the machine
 2. Secure the machine during nonmeal hours
 3. Never secure the machine during the hot months of the year
 4. Store the ice scoop inside the bin below the maximum ice level

ASSIGNMENT 4

Textbook Assignment: "Food Preparation," chapter 5, pages 5-1 through 5-27.

- 4-1. The use of standardized recipes by all branches of the military accomplishes which of the following objectives?
1. Prevents variation in food quality and quantity
 2. Accommodates the use of government provisions
 3. Promotes uniformity in food costs throughout the military
 4. Facilitates transfer of food items from one activity to another
- 4-2. Each recipe in the AFRS is designed to yield 100 portions; however, the yield of some recipes may be given in numbers of the product or volume.
1. True
 2. False
- 4-3. Ingredients are listed on each recipe card in which of the following orders?
1. From dry to liquid
 2. From liquid to dry
 3. From the largest to the smallest quantity
 4. From the first needed to the last
- 4-4. Under what circumstance are the quantities of dry ingredients on a recipe card usually given as both weights and measures?
1. When the recipe is for a bakery item
 2. When the recipe calls for a large amount of liquid
 3. When the recipe includes a small amount of dry ingredients
 4. When the quantities of dry ingredients weigh more than one-half of an ounce
- IN ANSWERING QUESTIONS 4-5 THROUGH 4-8, SELECT THE SECTION OF THE AFRS RECIPE CARD THAT IS DESCRIBED BY THE QUESTION.
- 4-5. Explains how the ingredients are to be combined and cooked and represents the best accepted cooking procedures.
1. Yield
 2. Method
 3. Notes
 4. Variations
- 4-6. Contains supplemental information such as possible substitutions for ingredients.
1. Abbreviations
 2. Notes
 3. Variations
 4. Ingredients
- 4-7. Includes specific techniques to supplement information contained in the Method column.
1. Notes
 2. Variations
 3. Ingredients
 4. Yield
- 4-8. Constitutes a major addition to the total number of recipes contained in the AFRS.
1. Variations
 2. Ingredients
 3. Method
 4. Notes
- 4-9. The abbreviation A.P. in the AFRS represents what meaning?
1. A portion
 2. As prepared
 3. As purchased
 4. As planned

IN ANSWERING QUESTIONS 4-10 THROUGH 4-12, SELECT THE AFRS RECIPE SUPPLEMENT THAT IS DESCRIBED BY THE QUESTION.

4-10. Located in some of the recipe sections as directions for preparing a basic type of food.

1. Index of recipes
2. General information cards
3. Guideline cards
4. Index cards

4-11. Used as a valuable reference for menu planners.

1. Index cards
2. General information cards
3. Guideline cards
4. Index of recipes

4-12. You should become familiar with this section first. It provides basic information.

1. Index of recipes
2. General information cards
3. Guideline cards
4. Index cards

4-13. The M section of the AFRS contains what category of recipes?

1. Soups
2. Sandwiches
3. Sauces, gravies, and dressings
4. Salad dressings and relishes

IN ANSWERING QUESTIONS 4-14 THROUGH 4-16, SELECT THE TYPE OF RECIPE ADJUSTMENT THAT MATCHES THE DESCRIPTION GIVEN AS THE QUESTION.

4-14. Used to increase or decrease a recipe to obtain the desired number of portions.

1. Volume
2. Serving size
3. Yield
4. Quantity

4-15. Used to adjust a recipe based upon the amount of an ingredient to be used.

1. Volume
2. Serving size
3. Yield
4. Quantity

4-16. Used to adjust recipes to yield a specific number of portions of a specific size.

1. Volume
2. Serving size
3. Yield
4. Quantity

4-17. Thirty pounds of ground beef is required to prepare 100 portions of chili and 150 portions must be prepared. Fifty-five pounds of ground beef was mistakenly thawed for this purpose. You are instructed to adjust the recipe based upon the amount of meat thawed. How many additional pounds will you have to make extra portions?

1. 10
2. 33
3. 34
4. 45

4-18. You are preparing Salisbury steak for 320 people and are instructed by the leading MS to make 3-ounce portions. What specific amount of ground beef is required to make these 3-ounce portions if the recipe calls for 30 pounds per 100 4-ounce portions?

1. 22 pounds
2. 22 pounds 8 ounces
3. 72 pounds
4. 72 pounds 8 ounces

- 4-19. If a recipe calls for 4 gallons of water per 100 portions, how much water would be needed to prepare 333 portions of this recipe?
1. 13 gal, 1 qt, 1 cup, 1 1/2 tbsp
 2. 13 gal, 2 qt, 1 cup, 1 tbsp, 2 3/4 tsp
 3. 13 gal, 1 qt, 1 cup, 1 tbsp, 2 3/4 tsp
 4. 13 gal, 2 qt, 1 cup, 2 tbsp
- 4-20. You are measuring water needed to prepare minestrone soup and you only have a 8-ounce measuring cup. What specific number of cups is equal to 3 1/2 gallons?
1. 54
 2. 56
 3. 58
 4. 60
- 4-21. When you are not using any counterweights, what is the maximum capacity of the basic scale?
1. 1 pound
 2. 2 pounds
 3. 5 pounds
 4. 4 pounds
- 4-22. Reconstituted egg mix must be handled in what manner if you do not use it immediately?
1. Discarded after being at room temperature for 1 hour
 2. Discarded 4 hours after preparation
 3. Refrigerated in a tightly covered container and discarded after 24 hours
 4. Refrigerated in a tightly covered container and used within 1 hour
- 4-23. When properly refrigerated, eggs that have been treated with processing fluids will have what maximum storage life?
1. 1 month
 2. 2 months
 3. 6 months
 4. 4 months
- 4-24. When using frozen eggs, you may thaw them using which of the following methods?
1. Place the eggs at room temperature until thawed
 2. Place the container in a sink and cover it with warm water
 3. Keep the eggs at 40°F to 45°F until thawed
 4. Keep the eggs at 36°F to 38°F until thawed
- 4-25. Which, if any, of the following food items are you authorized to prepare using raw (fresh) eggs?
1. French toast batter
 2. Mayonnaise
 3. Salad dressings
 4. None of the above
- 4-26. When fresh eggs are used in preparing scrambled eggs, you should comply with all EXCEPT which of the following requirements?
1. Do not use egg breaking machines
 2. Prepare 5-quart batches to meet excess demands
 3. Cook until there is no liquid egg visible
 4. Cook in small batches

4-27. When you are paring fresh fruits, discoloration can be prevented by which of the following actions?

1. Dipping the fruit in vinegar
2. Dipping the fruit in a solution of baking soda and water
3. Covering the fruit with water
4. Covering the fruit with lemon juice

4-28. Which of the following procedures should you use to wash leaf-type vegetables such as spinach?

1. Wash in several changes of cold water draining the water each time
2. Wash in several changes of cold water using a strainer
3. Wash in several changes of cold water lifting out the vegetables each time
4. Soak vegetables in cold salt water for a least one-half hour

4-29. You should cook canned vegetables using which of the following methods?

1. Discard the liquid and steam the vegetables for 10 minutes
2. Boil for 5 minutes in the liquid that was in the can
3. Simmer in a covered stockpot for 20 minutes
4. Bring to a boil just before they are to be served

IN ANSWERING QUESTIONS 4-30 THROUGH 4-33, SELECT THE METHOD FOR COOKING VEGETABLES THAT MATCHES THE DESCRIPTION GIVEN AS THE QUESTION.

4-30. This method is faster than other methods and helps to preserve the fresh appearance and nutritive value of the vegetables.

1. Baking
2. Simmering
3. Steaming
4. Roasting

4-31. Use of dry heat with the addition of little or no water.

1. Deep-fat frying
2. Simmering
3. Baking
4. Oven frying

4-32. The vegetables should be tender and cut in uniformly sized pieces.

1. Oven frying
2. Deep-fat frying
3. Stir-frying
4. Baking

4-33. This method of cooking is also referred to as sauteing.

1. Searing
2. Stir-frying
3. Deep-fat frying
4. Panfrying

4-34. Progressive vegetable cookery accomplishes all EXCEPT which of the following objectives?

1. Ensures a continuous supply of freshly cooked vegetables is available
2. Helps control waste
3. Diminishes the flavor of vegetables
4. Allows cooking of several small batches

4-35. For which of the following reasons is it better for you to undercook vegetables rather than overcook them?

1. To preserve color
2. To maintain the crisp or crunchy texture
3. To shorten the cooking time
4. To conserve the nutrient content

- 4-36. Which of the following vegetable salads would be suitable for you to serve as a main course for lunch or dinner?
1. Potato
 2. Garden
 3. Chef's
 4. Waldorf
- 4-37. Commercial salad dressing is different from mayonnaise in which of the following ways?
1. Cooked starch paste is added to mayonnaise
 2. Tomato paste is added to mayonnaise
 3. More oil is used to prepare mayonnaise
 4. Less oil is used to prepare mayonnaise
- 4-38. What is the basic rule that you should follow when preparing salad dressings?
1. Prepare immediately just before serving
 2. Prepare well in advance
 3. Add the seasoning just before serving
 4. Use only fresh herbs
- 4-39. When you are preparing mayonnaise, what element of the preparation process will cause it to curdle?
1. Not adding enough egg whites
 2. Not adding enough oil
 3. Adding the oil too fast
 4. Adding the oil too slow
- 4-40. What type of eggs are you authorized to use in galley-prepared mayonnaise or salad dressings?
1. Fresh eggs
 2. Frozen pasteurized eggs
 3. Frozen egg whites
 4. Dehydrated egg mix
- 4-41. At the end of the meal, what should you do with salad dressings that were served in separate containers?
1. Place them back into the original container and refrigerate
 2. Discard them only
 3. Label, refrigerate, then discard, if not used by the end of the day
 4. Label, refrigerate, and discard, if not used within 36 hours
- 4-42. All raw vegetables used to prepare relishes, except leafy varieties, should be refrigerated in icy cold water for at least how many minutes?
1. 15
 2. 20
 3. 30
 4. 60
- 4-43. When serving hors d'oeuvres, you will normally serve them at which of the following times?
1. During formal meals after each course
 2. Before formal or informal meals
 3. After formal or informal meals
 4. Between lunch and dinner as an appetizer
- 4-44. When you prepare sandwiches to be the primary item of a meal, what requirement should you meet?
1. An assortment of bread should be provided
 2. The sandwich should be served with a soup
 3. The type of sandwich must be a hot one
 4. The sandwich should be substantial

4-45. When you are preparing sandwiches, which of the following types of bread is preferable?

1. Day-old
2. Freshly baked
3. Commercial
4. White

4-46. You should NOT store bread in a chilled space for what reason?

1. To prevent the absorption of odors and flavors
2. To prevent the absorption of moisture
3. To prevent the moisture loss
4. To prevent the bread from rapidly becoming stale

4-47. You may use all EXCEPT which of the following types of fillings to prepare sandwiches for sandwich meals?

1. Peanut butter and jelly
2. Cold cuts
3. Sloppy Joe's
4. Ham salad

4-48. All EXCEPT which of the following statements describe a sanitary precaution used in preparing sandwiches?

1. Never allow sandwiches to stand at room temperature for more than 4 cumulative hours
2. Keep time between preparation and consumption to a minimum
3. Serve lettuce, tomatoes, and spreads used for sandwiches separately
4. Hold sandwiches containing hand-prepared ground meat below 40°F if not to be consumed immediately

IN ANSWERING QUESTIONS 4-49 THROUGH 4-52, SELECT THE TYPE OF SANDWICH THAT MATCHES THE DESCRIPTION GIVEN AS THE QUESTION.

4-49. Consists of three or more slices of toasted bread and two different fillings, one in each layer.

1. Club
2. Submarine
3. Hot
4. Open-faced

4-50. May be either one or two slices of bread covered with any desired filling including sliced meat, cheese, or tomatoes.

1. Open-faced
2. Submarine
3. Club
4. Grilled or toasted

4-51. Prepared from French bread or a hard roll cut in half lengthwise. Sliced cold meat, cheese, vegetables, and some type of dressing are used as fillings.

1. Grilled or toasted
2. Club
3. Finger
4. Submarine

4-52. Usually served open-faced with sliced meat and gravy. However, it is often served with a soup, a potato, and vegetables.

1. Hot
2. Club
3. Monte Cristo
4. Monte Carlo

4-53. During cold weather, you should place soup on the menu at least how often?

1. Once daily
2. Twice daily
3. Three times a day
4. At least every few days

- 4-54. When you use dehydrated soup and gravy bases to prepare stock for soups, what ingredient should you adjust or eliminate?
1. Water
 2. Meat
 3. Salt
 4. Herbs
- 4-55. What procedure should you use to prepare a warm roux?
1. Mix cornstarch with warm water
 2. Mix flour with warm water
 3. Mix cornstarch with cold water
 4. Mix flour with melted fat
- 4-56. When you check a soup for taste and it is too salty, what should you do to correct this problem?
1. Add more stock and simmer for a few minutes
 2. Add more water and simmer for a few minutes
 3. Add sliced raw potatoes and simmer for a few minutes
 4. Add sugar and simmer for a few minutes
- 4-57. Which of the following sauces should you use to bind the ingredients together in a scalloped dish?
1. Butter
 2. Medium white
 3. Thin cream
 4. Sweet thickened
- 4-58. What thickening agent, if any, should you use to thicken natural pan gravy?
1. Hot roux
 2. Cold roux
 3. Flour paste
 4. None; natural pan gravy is not thickened
- 4-59. Which of the following procedures should you use to remove lumps that may appear in gravy?
1. Add water
 2. Bring to a boil
 3. Add salad oil
 4. Whip vigorously
- 4-60. Stuffing poultry with dressing in GMs is not recommended for which of the following reasons?
1. The loss of the nutritional value if prepared this way
 2. Stuffing requires more moisture and will cause the poultry product to be dry
 3. The possibility of food-borne illness will increase
 4. Enough stuffing cannot be prepared for everyone using this method
- 4-61. Overstirring and overcooking cereal during preparation may produce which of the following results?
1. The cereal becomes sticky and gummy
 2. The cereal loses moisture content
 3. The cereal becomes thick
 4. The cereal becomes lumpy
- 4-62. In which of the following ways does vermicelli differ from spaghetti?
1. Vermicelli is thicker
 2. Vermicelli contains eggs
 3. Vermicelli is made from hard wheat flour
 4. Vermicelli cooks quicker
- 4-63. Which of the following types of rice is preferable as an accompaniment to oriental dishes because it will clump together when cooked?
1. Parboiled
 2. Medium-grained
 3. Long-grained
 4. Wild

- 4-64. What reference lists the characteristics and recommended use of each type of milk procured by the Navy?
1. NAVSUP P-421
 2. NAVSUP P-476
 3. NAVFSSNOTE 7330
 4. NAVMED P-5010-1
- 4-65. You can prevent bitterness in brewed coffee by taking which of the following measures?
1. Storing the coffee grounds in an airtight container
 2. Using the proper proportion of water in relation to coffee grounds
 3. Cleaning the coffeepot daily with hot soapy water
 4. Making sure the coffee is not brewed too long
- 4-66. To prevent deterioration of flavor and loss of aroma, coffee brewed in an automatic urn should not be held for more than what maximum number of minutes?
1. 20
 2. 30
 3. 45
 4. 60
- 4-67. What should you use to clean the urn of coffee-making equipment at the end of the day?
1. Hot water and urn cleaner
 2. Hot soapy water
 3. Vinegar and water
 4. Baking soda and water
- 4-68. The quality of brewed tea depends on how fast the flavor and color are extracted from the tea leaves. All EXCEPT which of the following factors influence this process?
1. The degree of softness of the water used
 2. The holding time used
 3. The amount of brewing time
 4. The brewing temperature used
- 4-69. For what reason is a stronger brew required for iced tea than for tea served hot?
1. To help preserve the flavor of the tea if it is to be chilled for a undetermined duration
 2. Because iced tea tastes better stronger
 3. Cold temperatures will weaken the brew
 4. Because of the diluting action of the added ice
- 4-70. When using instant concentrated tea, you should prepare the tea mix in which of the following manners?
1. Pour the concentrate into hot water
 2. Pour the concentrate into cold water
 3. Pour hot water into the receptacle containing the concentrated mix
 4. Pour cold water into the receptacle containing the concentrated mix

ASSIGNMENT 5

Textbook Assignment: "Meat, Poultry, and Seafood," chapter 6, pages 6-1 through 6-20;
"Nutrition and Menu Planning," chapter 7, pages 7-1 through 7-25.

- 5-1. The form of meat classified as fabricated is correctly described by which of the following statements?
1. Artificial meat products fabricated from other foods
 2. Meats that have been either partially or completely boned, trimmed, and portion-cut
 3. Meat that does not conform to the specifications of the armed forces
 4. Meat not requiring inspection by the Department of Agriculture

IN ANSWERING QUESTIONS 5-2 THROUGH 5-5,
SELECT THE CATEGORY OF BEEF THAT IS
DESCRIBED BY THE QUESTION.

- 5-2. Beef originating from a young male that is castrated.

1. Stag
2. Bull
3. Steer
4. Calf

- 5-3. Beef originating from a fully developed male.

1. Stag
2. Bull
3. Steer
4. Bronco

- 5-4. Beef originating from a young female that has not borne a calf.

1. Calf
2. Cow
3. Mare
4. Heifer

- 5-5. Beef originating from a mature male that is castrated.

1. Steer
2. Bull
3. Stag
4. Stallion

- 5-6. Cows, bulls, and stags are most suitable for use in Navy messes; whereas steers and heifers are usually found in canned products.

1. True
2. False

- 5-7. The USDA stamp is placed on the carcasses of meat to indicate which of the following conditions?

1. Meat originated in the United States
2. Meat delivered under contract met all the terms of the contract
3. Meat is graded as being prime or choice
4. Meat is free of disease and meets sanitary requirements

- 5-8. Beef roasts procured by the Navy are what grade of meat?

1. Choice
2. Good
3. Utility
4. Standard

- 5-9. Which of the following pork products is/are served with the highest frequency?

1. Loin
2. Chops
3. Spareribs
4. Bacon

- 5-10. Each pound of canned precooked bacon is equivalent to how many pounds of raw bacon?
1. 1 1/2
 2. 2
 3. 3
 4. 2 1/2
- 5-11. You may serve canned ham without first cooking it because it has undergone what process?
1. Curing
 2. Smoking
 3. Pasteurization
 4. Pickling
- 5-12. Veal is a product of which of the following animals?
1. Corn-fed lamb
 2. Immature beef less than 1 year old
 3. Immature sheep less than 1 year old
 4. Immature swine less than 1 year old
- 5-13. What cut of lamb is used in Navy GMs?
1. Loin chops
 2. Shoulder roast
 3. Boneless leg roast
 4. Boneless shank roast
- 5-14. For which of the following reasons should you use the preferred method of slowly thawing frozen meats, whenever possible?
1. Meat thawed this way yields a more palatable cooked product
 2. Meat thawed this way has less nutrient loss
 3. The preferred method decreases the chance of bacterial contamination
 4. Each of the above
- 5-15. When you are using an alternate thawing method, all EXCEPT which of the following procedures are required?
1. Obtaining approval from the Bureau of Medicine and Surgery
 2. Notifying the medical department representative
 3. Thawing in the original sealed wrapper or container below 80°F
 4. Thawing in the original unopened container at 50°F or lower
- 5-16. Approximately twice the cooking time is required when you cook roasts in their frozen state?
1. True
 2. False
- 5-17. For meat to be properly tempered, it should have what specific internal temperature range?
1. 12°F to 15°F
 2. 16°F to 18°F
 3. 23°F to 26°F
 4. 26°F to 28°F
- 5-18. What criteria determine the method you should use to cook meat?
1. The types of cooking equipment in your GM
 2. The preferences of the food service officer
 3. The kind of meat and the tenderness of the cut
 4. The cost of the meat and the occasion
- 5-19. What method is most often used to cook the least tender cuts of meat?
1. Stewing
 2. Frying
 3. Braising
 4. Boiling

- 5-20. What cooking method is used when you brown meat in a small amount of fat, cover, then cook slowly in the juices from the meat or in a small amount of liquid that is added?
1. Simmering
 2. Stewing
 3. Braising
 4. Steaming
- 5-21. You should use which of the following methods to cook tender cuts of meat that have little connective tissue?
1. Braising
 2. Stewing
 3. Simmering
 4. Roasting
- 5-22. When grilling is the cooking method, you should not use a fork to turn meat for what reason?
1. A fork is a heat conductor
 2. A spatula is more manageable
 3. Using a fork allows the juices of the meat to escape
 4. A fork may damage the grill surface
- 5-23. At which of the following times should you apply the seasoning when you are grilling meat?
1. Before placing the meat on the grill
 2. Before you turn the meat over
 3. After you turn the meat over
 4. After the meat has been completely cooked
- 5-24. When roasting meat, you should place the roasts fat-side-up for what reason?
1. To avoid oven frying the food
 2. To eliminate having to trim the fat after the meat is done
 3. To prevent searing the meat which causes excessive shrinkage
 4. To eliminate the need to baste the meat during cooking
- 5-25. What factor affects the cooking time of a roast?
1. The amount of liquid used
 2. The oven capacity
 3. The type of seasoning used
 4. The degree of doneness desired or required
- 5-26. Turkeys weighing more than 16 pounds will require what range of days to thaw in a thaw box?
1. 1 to 2
 2. 2 to 3
 3. 3 to 4
 4. 5 to 6
- 5-27. You are NOT required to rub which of the following poultry products with salad oil before roasting?
1. Cornish hen
 2. Duck
 3. Turkey
 4. Chicken
- 5-28. Roasted turkey has reached the required stage of doneness when the internal temperature registers what specific temperature range?
1. 160°F to 165°F
 2. 170°F to 175°F
 3. 180°F to 185°F
 4. 190°F to 195°F
- 5-29. Navy nutrition is concerned with achieving all EXCEPT which of the following objectives?
1. Preservation of nutrients
 2. What components are needed and how much is required by the body
 3. How foods are altered in processing, storage, and preparation
 4. Producing the least expensive menus

5-30. The body's needs for the various nutrients are influenced by which of the following factors?

1. Age
2. Gender
3. Occupation
4. Each of the above

5-31. A well-balanced meal is only obtained by including a specific portion from each of the various food groups. What total number of nutrients should this balanced meal provide?

1. Eight
2. Six
3. Five
4. Four

IN ANSWERING QUESTIONS 5-32 THROUGH 5-34, SELECT THE FOOD NUTRIENT(S) THAT MATCH(ES) THE DESCRIPTION GIVEN AS THE QUESTION.

5-32. The chief suppliers of tissue-building material.

1. Proteins
2. Minerals
3. Vitamins
4. Carbohydrates

5-33. Provides the highest amount of calories.

1. Carbohydrates
2. Proteins
3. Fats
4. Minerals

5-34. Stored in the muscles as glycogen.

1. Water
2. Carbohydrates
3. Minerals
4. Vitamins

5-35. Which of the following minerals is the most abundant in the human body?

1. Phosphorus
2. Iron
3. Iodine
4. Calcium

5-36. Which of the following minerals is responsible for carrying oxygen to the blood?

1. Phosphorus
2. Calcium
3. Iron
4. Iodine

5-37. Which of the following foods is the best source of iron?

1. Collard greens
2. Milk
3. Liver
4. Bread

5-38. A deficiency of what mineral can cause swelling (goiter) of the thyroid gland?

1. Salt
2. Iodine
3. Iron
4. Calcium

5-39. A person that does not perspire much needs what minimum number of teaspoons of salt per day?

1. 1
2. 2 to 3
3. 3 to 4
4. 4 to 5

5-40. Which of the following groups of vitamins are all fat soluble?

1. A, B, C, and K
2. A, B, D, and K
3. A, B, E, and K
4. A, D, E, and K

5-41. What vitamin plays a very important role in eye function and in keeping the skin and mucous membranes resistant to infection?

1. A
2. C
3. E
4. K

5-42. Sunlight enables your body to produce what vitamin if it has a chance to shine directly on the skin?

1. B₆
2. B₁₂
3. D
4. K

IN ANSWERING QUESTIONS 5-43 THROUGH 5-46, SELECT THE VITAMIN THAT MATCHES THE DESCRIPTION GIVEN AS THE QUESTION.

5-43. Needed in order to use calcium and phosphorus to build strong bones and teeth.

1. B₁₂
2. C
3. D
4. K

5-44. Presently being explored as an antioxidant that may retard some aspects of the aging process.

1. B₁
2. B₂
3. E
4. K

5-45. Essential for the manufacture of a substance that helps blood to clot.

1. A
2. B₁
3. B₁₂
4. K

5-46. Deficiency causes beriberi, a disease that is now almost nonexistent in the United States.

1. B₁
2. B₂
3. B₆
4. B₁₂

5-47. Strict vegetarians are likely to be deficient in what vitamin?

1. B₆
2. B₁₂
3. Niacin
4. Folic acid

5-48. You should use the food guide pyramid for daily food choices on menus to accomplish what objective?

1. To eliminate the need for menu review boards
2. To determine the foods that have the highest acceptability
3. To quickly and reliably judge the nutritional adequacy of the menu
4. To give a detailed analysis of the cost of the menu

5-49. Nursing mothers require what specific number of servings daily from the milk-cheese group?

1. Five
2. Two
3. Three
4. Four

5-50. Fortified low-fat or skim milk products have essentially the same calories as whole milk products but less fat content.

1. True
2. False

- 5-51. Foods from the meat group are valued primarily for providing which of the following substances?
1. Calcium
 2. Carbohydrates
 3. Protein
 4. Fiber
- 5-52. Which of the following foods from the meat-poultry-fish-dry beans-egg-nuts group is/are a good source of zinc?
1. Oysters
 2. Tuna
 3. Egg yolks
 4. Dry beans
- 5-53. Which of the following publications lists all the food items procured by the Navy?
1. *Afloat Shopping Guide*
 2. *Federal Supply Catalog*
 3. *Consolidated Afloat Requisitioning Guide Overseas (CARGO)*
 4. *Atlantic Fleet Requisitioning Guide*
- 5-54. When planning menus, you should include all EXCEPT which of the following considerations in determining the choice of menu items?
1. The type and capacity of the galley equipment
 2. The number of personnel to be fed
 3. The number of workers in the galley
 4. The planner's personal preferences
- 5-55. The acceptability of a food item can be determined by using all EXCEPT which of the following methods?
1. Dividing the number of portions served by the number of portions prepared
 2. Averaging the figures obtained for a particular menu item over a period of time
 3. Monitoring tray waste
 4. Dividing the number of portions served by the number of patrons attending the meal
- 5-56. A 42-day menu with valid acceptability factors can be used to estimate the requirements for a 45-day loadout. What fraction of initial requirements must you add for a 60-day period?
1. 3/8
 2. 1/5
 3. 1/3
 4. 1/4
- 5-57. What foodservice guide contains useful information on commodities, equipment for galley use, GM modernization, and suggested special event or holiday menus?
1. *Navy Foodservice*
 2. *Federal Supply Catalog*
 3. *NAVSUPINST 461.11*
 4. *NAVSUP P-486, volume I*
- 5-58. When predicting meal attendance, you should consider all EXCEPT which of the following factors?
1. Proximity to payday
 2. Liberty trends
 3. The weather
 4. GM capacity

ASSIGNMENT 6

Textbook Assignment: "Breads and Desserts," chapter 8, pages 8-1 through 8-27.

- 6-1. When preparing cakes, cookies, quick breads, pastries, and pies, you should use what type of flour?
1. Hard wheat
 2. Soft wheat
 3. General-purpose
 4. Whole wheat
- 6-2. General-purpose flour contains more protein than bread flour.
1. True
 2. False
- 6-3. When combined with water, what food component(s) of wheat flour form(s) gluten?
1. Bran
 2. Proteins
 3. Carbohydrates
 4. Minerals
- 6-4. What food component(s) of wheat flour is/are responsible for absorbing water and giving bulk to dough?
1. Enzymes
 2. Bran
 3. Proteins
 4. Carbohydrates
- 6-5. For which of the following reasons are some types of flour enriched?
1. To increase storage life of the flour
 2. To increase the dough's expansion qualities
 3. To replace the food value lost in milling
 4. To produce fermentation properties needed in baking
- 6-6. Which of the following components of flour is the enzyme that is responsible for converting starch into sugar?
1. Diastase
 2. Protease
 3. Gliadin
 4. Glutenin
- 6-7. Gluten is capable of absorbing what percentage of its own weight in water?
1. 50
 2. 75
 3. 100
 4. 200
- 6-8. When you are making bread, the use of too much salt will produce which of the following results?
1. Accelerated fermentation
 2. Retarded fermentation
 3. A heavy baked product
 4. A coarse baked product
- 6-9. When you use a liquid shortening to prepare a dough product, which of the following criteria must be met?
1. The shortening must be an emulsifier type
 2. The shortening must be hydrogenated
 3. The liquid shortening must be salad oil
 4. The dough must be well formed before the oil is added

- 6-10. When you substitute butter for shortening in a dough or batter recipe, what adjustment should be made?
1. Increase the liquid to be used
 2. Use milk instead of water as the liquid
 3. Use nonfat dry milk in place of liquid milk
 4. Use more butter than the required amount of shortening in the recipe
- 6-11. Before reconstituted egg mix is used in dough preparation, you should remove it from the refrigerator and warm to room temperature for over 1 hour.
1. True
 2. False
- 6-12. Active dry yeast should be suspended for 5 minutes in about seven times its weight of water at what specific temperature range before it is used?
1. 95°F to 100°F
 2. 100°F to 104°F
 3. 105°F to 110°F
 4. 111°F to 115°F
- 6-13. For you to use baking soda as a leavening agent, which of the following ingredients must be present in a recipe?
1. Liquid shortening
 2. Sugar
 3. Salt
 4. Vinegar
- 6-14. As a baker, you would use a friction factor to determine which of the following factors?
1. Temperature rise induced by mixing
 2. Required room temperature
 3. Required flour temperature
 4. Desired dough temperature
- 6-15. Bread dough should range between what specific temperatures when the mixing process is completed?
1. 86°F and 90°F
 2. 82°F and 86°F
 3. 78°F and 82°F
 4. 74°F and 78°F
- 6-16. The length of the fermentation period of a dough depends on all EXCEPT which of the following factors?
1. Amount of yeast used
 2. Strength of the flour
 3. Time needed to mix the dough
 4. Temperature during fermentation
- 6-17. Under which of the following circumstances is dough considered to be old dough?
1. When it is fermented at too high a temperature
 2. When it has already been punched
 3. When it has been mixed too long
 4. When it has been fermented too long
- 6-18. Before you take dough to the bench for makeup, you should allow it to rest for approximately what number of minutes?
1. 10
 2. 15
 3. 20
 4. 30
- 6-19. Which of the following indicators should you use to determine that a loaf of bread has been properly baked?
1. The loaf has split down the center of the top
 2. The loaf has a hollow sound when tapped
 3. The loaf's top has a flat surface
 4. The loaf slopes outward on the top

- 6-20. If freezer storage for bread is impractical, you can best maintain its quality by baking in quantities that will be consumed within what specific number of days?
1. 6
 2. 2
 3. 7
 4. 4
- 6-21. In the event that rope develops in your bakeshop, you should perform which of the following actions?
1. Inform the damage control officer
 2. Increase the humidity in the space to correct the problem
 3. Have a medical department representative inspect all baked products for safety
 4. Dispose of all baked products and baking ingredients in the shop
- 6-22. In addition to water, what other ingredient must you add to canned hot roll mix before mixing it?
1. Baking powder
 2. Baking soda
 3. Yeast
 4. Vinegar
- 6-23. At what temperature must you finish baking brown-and-serve rolls after they have been baked at 300°F for 12 to 15 minutes?
1. 350°F
 2. 375°F
 3. 400°F
 4. 425°F
- 6-24. When you are mixing quick breads and batters, what general rule applies?
1. Limit mixing when the leavening is produced by baking powder
 2. Limit mixing when the product contains a high percentage of fat
 3. Quick breads and batters are mixed in the same manner
 4. Add the dry ingredients to the liquid ingredient while mixing at fast speed
- 6-25. You prepare the batter for which of the following products by mixing the ingredients only long enough to yield a uniform structure?
1. Doughnuts
 2. Dumplings
 3. French bread
 4. Biscuits
- 6-26. What type of mix should you use to prepare quick coffee cake?
1. White cake
 2. Yellow cake
 3. Biscuit
 4. Shortbread
- 6-27. Yankee-style cornbread is a cornbread variation that is prepared without sugar.
1. True
 2. False
- 6-28. The doughnut formula is prepared the same as the basic sweet dough formula in all EXCEPT which of the following ways?
1. Leavening and eggs are decreased
 2. Leavening and eggs are increased
 3. Only cake flour is used
 4. Only general-purpose flour is used

- 6-29. The temperature of doughnut ingredients at the time they are mixed will affect which of the following processes during frying?
1. Proper sizing of the doughnuts
 2. Amount of fat absorbed by the doughnuts
 3. Color of the doughnuts
 4. Ability of the doughnuts to brown
- 6-30. You should cool doughnuts to what specific temperature if they are to be glazed?
1. 72°F
 2. 96°F
 3. 140°F
 4. 160°F
- 6-31. By omitting sugar as an ingredient, you may use which of the following dough formulas to prepare pizza dough?
1. Sweet dough
 2. French bread
 3. Hot rolls, short-time
 4. Biscuit
- 6-32. A sponge cake is considered to be what type of cake?
1. Batter
 2. Angel food
 3. Chiffon
 4. Foam
- 6-33. A cake containing both foam and batter, mixed separately and folded to a single mixture, is classified as what type of cake?
1. Angel food
 2. Chiffon
 3. Pound
 4. Devil's food
- 6-34. Which of the following functions does salt perform as a cake ingredient?
1. Furnishes structure to the other ingredients
 2. Helps the cake retain its moisture
 3. Brings out the flavor of the other ingredients
 4. Acts as a tenderizing agent
- 6-35. When preparing to bake angel food cakes, you should not grease the cake pans for what reason?
1. The fat will keep the cake from rising
 2. The cake will develop an objectionable taste
 - 3* The cake mix already contains enough fat to prevent sticking
 4. The fat will cause the bottom and sides of the cake to brown too quickly
- 6-36. At what stage of the cake baking process does the batter rise to become higher in the center than at the edges?
1. 1st
 2. 2d
 3. 3d
 4. 4th
- 6-37. When you are baking cakes in a conventional oven, what condition may result from opening the oven door before the baking time is completed?
1. The cake will require additional baking time because of the loss of heat
 2. The loss of contained moisture will cause the cake to dry out
 3. The cake may not brown
 4. The cake may fall

- 6-38. When using a convection oven to bake cakes, you should allow them to bake for what specific range of minutes before turning on the blower?
1. 3 to 4
 2. 5 to 6
 3. 7 to 10
 4. 11 to 15
- 6-39. When baking cakes and discovering that the cakes are cooking too quickly, you should take what action?
1. Open the oven door for several minutes
 2. Close the vent for several minutes
 3. Turn off the blower for 15 minutes
 4. Reduce the heat 15°F to 25°F
- 6-40. When baking cakes to prepare jelly rolls, once they are done baking, what step should you perform next?
1. Chill them
 2. Glaze them
 3. Sprinkle them with sugar
 4. Remove them from the pans while they are still hot
- 6-41. Cakes baked in a standard 18- by 26-inch sheet-cake pan should be sliced in what number of portions?
1. 48
 2. 52
 3. 54
 4. 56
- 6-42. You should store cakes that are not to be used immediately at what specific temperature range?
1. 32°F to 34°F
 2. 35°F to 40°F
 3. 50°F to 70°F
 4. 75°F to 95°F
- 6-43. Which of the following publications extensively describes cake decorating techniques?
1. NAVSUP P-421
 2. NAVSUP P-476
 3. NAVSUP P-486
 4. NAVSUP P-530
- 6-44. What frosting will prevent running or weeping when used to decorate a cake?
1. Butter cream
 2. Royal
 3. Caramel
 4. Cooked
- 6-45. Cookies are classified in what manner?
1. By the texture of the finished product
 2. By the properties of the dough ingredients
 3. By the method used to mix the dough
 4. By the dough moisture content
- 6-46. Soft-batter cookie dough requires a greater percentage of what ingredient to give it structure?
1. Flour
 2. Water
 3. Fat
 4. Egg
- 6-47. When you overmix cookie dough, you will encounter what problem during the cooking process?
1. The spreading of the cookies will be retarded
 2. The cookies will spread too much
 3. The cookies will become spotted
 4. The cookies will become brittle and break easily

- 6-48. How many No. 10 cans of cookie mix will you need to prepare 175 oatmeal cookies?
1. Five
 2. Two
 3. Three
 4. Seven
- 6-49. Which of the following characteristics is NOT an indication that a piecrust has been properly made?
1. A golden brown appearance
 2. A rough surface that appears blistered
 3. An elastic or coarse texture
 4. A crust tender enough to cut easily
- 6-50. The shortening used to prepare pie dough should be at what temperature when you are ready to blend it with the other ingredients?
1. 45°F
 2. 50°F
 3. 60°F
 4. 80°F
- 6-51. You should use bakery emulsifier shortening, melted shortening, or salad oil to prepare piecrust if a general-purpose shortening compound is not available.
1. True
 2. False
- 6-52. Which of the following factors is important in making a tender piecrust?
1. The quantity of water
 2. The method of mixing the water with the other ingredients
 3. The temperature of the water (40°F to 50°F)
 4. Each of the above
- 6-53. When you are mixing pie dough by machine, the water is added in what manner?
1. Placed in the bowl first, then the dry ingredients are gradually added while mixing
 2. Half all at once and the other half when the dough starts to form
 3. Added gradually while mixing
 4. Added all at once while mixing
- 6-54. The dough sections for the bottom crust of a two-crust pie should be cut into pieces weighing what specific number of ounces?
1. 7
 2. 7 1/2
 3. 8
 4. 8 1/2
- 6-55. After you place the pie dough in the pie pan and form the edges for a one-crust pie, the dough should be pricked with a fork to allow the steam formed during baking to escape. What is this procedure called?
1. Fluting
 2. Docking
 3. Scoring
 4. Aerating
- 6-56. To eliminate shrinkage and cracking in pumpkin pie during baking, the mixture for the filling must set for how many minutes before you add the eggs?
1. 20
 2. 30
 3. 40
 4. 60

6-57. When preparing lemon pie filling according to the AFRS, you should use what ingredient as the required liquid?

1. Water
2. Milk
3. Lemon juice
4. Cream

6-58. You may use all EXCEPT which of the following ingredients to prepare a chiffon pie?

1. Whipped topping
2. Meringue topping
3. Fruit gelatin
4. Fresh fruit

6-59. When adding fruit to a gelatin, you should observe what rule?

1. Use only canned fruit
2. Decrease the amount of water used
3. Never add uncooked fresh pineapple
4. Never substitute the liquid from canned fruit as part of the water

6-60. Ambrosia is a fruit cup to which what ingredient has been added?

1. Pecan
2. Coconut
3. Whipped topping
4. Cinnamon

ASSIGNMENT 7

Textbook Assignment: "Foodservice," chapter 9, pages 9-1 through 9-18.

- 7-1. To provide good foodservice in any foodservice operation, it is necessary to employ all EXCEPT which of the following tools?
1. The ability to properly prepare and serve food
 2. The ability to properly train foodservice personnel
 3. Good customer relations
 4. An unlimited budget
- 7-2. The guidelines for attractive food presentation and serving techniques in the GM are geared to elaborate restaurant operations.
1. True
 2. False
- 7-3. Which of the following meat items should you serve in a shallow insert?
1. Fried chicken
 2. Breaded veal cutlets
 3. Beef stroganoff
 4. Pork chop suey
- 7-4. To make sure customers receive an appetizing, palatable portion of french-fried eggplant, you should serve it in what manner?
1. Stacked in a deep insert only
 2. Stacked in a deep insert containing a strainer
 3. Spread loosely in a shallow insert
 4. Stacked in a shallow insert
- 7-5. Which of the following food items is prepared in full-sized shallow steam table pans?
1. Baked Cornish hen
 2. Swiss steak
 3. Baked lasagna
 4. Meat loaf
- 7-6. By ensuring the proper serving tool is used for each dish served, you will accomplish which of the following objectives?
1. A reduction of food waste
 2. A maintenance of the food's appetizing appearance
 3. Proper portion control
 4. Each of the above
- 7-7. What person is responsible for determining the portion size appropriate for each meal?
1. Galley supervisor
 2. Galley watch captain
 3. Leading MS
 4. Food service officer
- 7-8. You should use the portion size shown on a recipe card in what manner?
1. As a fixed standard
 2. As a weight control device
 3. As a foodservice rule
 4. As a general guide
- 7-9. For better portion control, you should serve mashed potatoes, rice, bread dressings, and baked beans using what serving utensil?
1. Dipper
 2. Scoop
 3. Nonperforated spoon
 4. Basting spoon

IN ANSWERING QUESTIONS 7-10 THROUGH 7-13, SELECT THE SERVING UTENSIL USED TO SERVE THE FOOD ITEM THAT IS GIVEN AS THE QUESTION.

7-10. Scrambled eggs.

1. Tongs
2. Food turner
3. Basting spoon
4. Scoop

7-11. Peas or cabbage.

1. Ladle
2. Basting spoon
3. Perforated spoon
4. Scoop

7-12. Asparagus or broccoli.

1. Food turner
2. Perforated spoon
3. Basting spoon
4. Tongs

7-13. Salad dressings.

1. Small ladle
2. 1-ounce scoop
3. Tablespoon
4. 2-ounce dipper

7-14. What type of light will make foods appear more attractive on the serving line?

1. Red
2. Bright
3. Natural
4. Yellow

7-15. In what order is it recommended that you arrange hot foods on the serving line?

1. Main entrée, sauce or gravy, potatoes or potato substitute, vegetables, and soup
2. Main entrée, soup, sauce or gravy, potatoes or potato substitute, and vegetables
3. Soup, main entrée, sauce or gravy, potatoes or potato substitute, and vegetables
4. Soup, potatoes or potato substitute, main entree, sauce or gravy, and vegetables

7-16. When possible, you should place the dessert bar in what section of the messing area?

1. At the end of the main serving line
2. After the salad bar
3. Between the main serving line and the salad bar
4. In the center of the messing area

7-17. In what manner should noncream puddings and similar desserts be served?

1. Portioned as the patrons approach the dessert bar
2. Spooned neatly into bowls and dishes for the patron to choose
3. Kept inside the chill box until requested
4. Self-served

7-18. You may serve bulk cold drinks and juices in all EXCEPT which of the following manners?

1. From a milk dispenser
2. From a noncarbonated beverage dispenser
3. From glass or plastic pitchers
4. In their original containers

- 7-19. If the physical setup of the mess allows, in what location should you place the salad bar?
1. Where the patron can choose a salad first
 2. Next to the chill box
 3. After the main serving line
 4. In the center of the messing area
- 7-20. A GM gains all EXCEPT which of the following benefits by using both a normal and a speed line?
1. A reduced waiting line
 2. A more pleasant atmosphere
 3. The need for a cycle menu
 4. An easier prepared menu
- 7-21. You should classify a meal consisting of pot roast, mashed potatoes, brown gravy, peas, celery sticks and sweet pickles, hot rolls, and blueberry pie as what type of meal?
1. An expensive meal
 2. A low-calorie meal
 3. A built-in garnished meal
 4. A holiday meal
- 7-22. When you are garnishing food items, which of the following practices is encouraged?
1. The use of food coloring to supply color contrast
 2. The use of restraint
 3. The use of inedible garnishes
 4. The use of elaborate garnishes
- 7-23. When preparing to slice a roast, you should first cut one slice across the top of the roast for what purpose?
1. To provide a surface to place the meat fork
 2. To allow the meat to become firm
 3. To permit the meat to be sliced with greater ease
 4. To determine the direction of the grain of the roast
- 7-24. When you control sliced meat portions by weight rather than by the number of slices, you can satisfy the patron's preference for thick or thin meat slices.
1. True
 2. False
- 7-25. What person sets the hours for the serving of meals?
1. Executive officer
 2. Food service officer
 3. Officer of the day or duty officer
 4. Commanding officer
- 7-26. As a general rule, you should set up the serving line what specific number of minutes before the regular meal?
1. 10
 2. 15
 3. 30
 4. 45
- 7-27. Before dishing out stew, chili con carne, or any similar item to a patron, you should stir the item for what reason?
1. To conceal the grease content
 2. To ensure the hottest portion possible
 3. To maintain the foods appetizing appearance
 4. To distribute the solid particles and the liquid evenly
- 7-28. Salt and pepper shakers should be emptied, prewashed, and put through the dishwashing machine at what frequency?
1. Daily
 2. Weekly
 3. Twice weekly
 4. Twice monthly

- 7-29. In a messing facility, what is the recommended location to place silverware?
1. At the beginning of the main serving line
 2. At the end of the main serving line
 3. After the dessert bar
 4. Before the salad bar
- 7-30. You should conduct an inventory of all dinnerware at what frequency to make sure there is enough to last an entire meal?
1. Daily
 2. Weekly
 3. Twice weekly
 4. Twice monthly
- 7-31. The type of meal service used in a wardroom is determined by which of the following factors?
1. Specific wardroom design
 2. The number of mess members
 3. The desires of the mess caterer
 4. Each of the above
- 7-32. What is the maximum number of courses that may be served during a formal meal?
1. Six
 2. Seven
 3. Eight
 4. Nine
- 7-33. What foodservice element distinguishes the semiformal meal style from the informal meal style?
1. The individual place settings
 2. The occasion for the meal
 3. The method of food preparation
 4. The method of meal service

IN ANSWERING QUESTIONS 7-34 THROUGH 7-37, SELECT THE STYLE OF MEAL SERVICE THAT IS DESCRIBED BY THE QUESTION.

- 7-34. The food is attractively arranged in the pantry or galley in the proper serving dishes, then placed on the table with the proper serving utensils.
1. American
 2. A la carte
 3. Cafeteria
 4. Family
- 7-35. The style of meal service that is often combined with other traditional forms of service.
1. American
 2. A la carte
 3. Family
 4. Cafeteria
- 7-36. The style of meal service that is usually provided at breakfast.
1. Family
 2. Cafeteria
 3. A la carte
 4. American
- 7-37. The style of meal service that can be used for both formal and informal meals.
1. American
 2. Buffet
 3. Cafeteria
 4. A la carte
- 7-38. You should provide a set of standard center items for what number of diners?
1. Every eight
 2. Every six
 3. Every five
 4. Every four

- 7-39. During an informal-style lunch or dinner meal, you should place the bread on the table at what specific time?
1. After all the courses have been served
 2. After the main course is served
 3. As soon as the diners are seated
 4. 5 minutes before the meal
- 7-40. When, if ever, during wardroom service, can you use linen that is worn, yet clean and without stains?
1. Only at breakfast meals
 2. Only when used for the buffet table
 3. Only when used for the sideboard
 4. Never
- 7-41. What term is used to describe the dishes, silver, glasses, and napkin that are placed in front of each person?
1. Space
 2. Placing
 3. Spread
 4. Cover
- 7-42. You should place the silverware what number of inches from the edge of the table?
1. 1
 2. 2
 3. 3
 4. 4
- 7-43. Normally, what is the maximum number of pieces of silverware that are placed at a cover?
1. Eight
 2. six
 3. Five
 4. Four
- 7-44. When used, the bread and butter plate should be placed in what location on the table?
1. To the left of the dinner plate, above the points of the forks
 2. To the right of the dinner plate, above the tips of the knives
 3. To the upper right of the outer spoon
 4. To the left of the forks or on the dinner plate
- 7-45. You should serve breakfast juice in what type of glass?
1. Short 10-ounce glass
 2. Tall, narrow 10-ounce glass
 3. Small 6-ounce glass
 4. Tall, narrow 6-ounce glass
- 7-46. When place cards are used, you should set them in what location on the table?
1. Centered at the top of the dinner plate
 2. Centered on top of the dinner plate
 3. Laid flat on top of the napkin
 4. Placed in front of the napkin
- 7-47. When setting up the beverage service for 36 diners, you should prepare what number of pots of coffee?
1. 6
 2. 9
 3. 3
 4. 12

- 7-48. At what time should you have water available during a wardroom meal?
1. During formal meals when wines are being served
 2. During informal meals when another beverage is being served
 3. Only when coffee is not being served
 4. Water should always be available

IN ANSWERING QUESTION 7-49, REFER TO FIGURE 9-6.

- 7-49. When the commanding officer has his or her own mess and is invited to the wardroom for a meal, what seat number does he or she occupy at the table?

1. 1
2. 2
3. 3
4. 10

- 7-50. Seating arrangements for officers with the same date of rank are determined in what manner?

1. By the mess caterer
2. By job title
3. By use of the buck
4. By lineal numbers

- 7-51. When officers of more than one staff corps have the same running mate, which of the following corps takes precedence over the others?

1. Supply corps
2. Chaplain Corps
3. Medical Corps
4. Civil Engineering Corps

- 7-52. What person normally approves the wardroom seating arrangements when several guests are to be present?

1. Commanding officer
2. Mess president
3. Mess caterer
4. Food service officer

- 7-53. During wardroom meal service, what specific situation will require you to serve from the right?

1. Serving wardroom meals aboard a submarine
2. Serving breakfast a la carte style
3. When it is the commanding officer's preference
4. When you are serving beverages

- 7-54. When you are using the cafeteria style of service, which of the following methods may be used to refill water glasses?

1. Leaving water pitchers on the table
2. Placing water pitchers on the sideboard
3. Having the diners refill their glasses from the drink dispenser
4. Having the wardroom attendant stand by to refill glasses upon request

- 7-55. When no guest of honor is present and more than one officer has guests, what person is served first?

1. Mess president
2. Senior host officer
3. Senior line officer present
4. Guest of the senior host officer

- 7-56. During a formal meal, the service plate remains in front of each diner until immediately after what course has been served?

1. Appetizer
2. Salad
3. Soup
4. Main course

7-57. At what point in a formal meal should you use a folded napkin and a tray to remove crumbs from a dining table?

1. After the main course dishes are cleared only
2. Before the salad is served only
3. Before the dessert is served only
4. Whenever any course is completed

7-58. During a formal meal, you should serve coffee at which of the following times?

1. Whenever it is requested
2. When the dessert is served
3. Both 1 and 2 above
4. Upon completion of the main course

7-59. During an informal meal, what procedure should you use to refill a diner's glass?

1. Let the diner hold the glass up for you
2. Have the diner tilt the glass toward you
- 3* Pick up the diner's glass and pour
4. Pour the beverage while the glass remains in place on the table

7-60. You should never fill pitchers used to serve beverages to more than what maximum level?

1. 1/2 full
2. 5/8 full
3. 2/3 full
4. 3/4 full

ASSIGNMENT 8

Textbook Assignment: "Quarters Afloat and Ashore," chapter 10, pages 10-1 through 10-19; and "Field Kitchens," chapter 11, pages 11-1 through 11-15.

- 8-1. Directives and letters of guidance for the operation of officers' quarters afloat originates from what activity?
1. BUPERS
 2. COMNAVSUPSYSCOM
 3. DPSC
 4. NAVFSSO
- 8-2. What person is responsible to the mess president for the service, care, and maintenance of quarters afloat?
1. Leading mess petty officer
 2. Mess caterer
 3. Stateroom supervisor
 4. Messdeck master-at-arms
- 8-3. As an MS working in officer's quarters afloat, you should make sure linen and towels are changed at what frequency?
1. Daily
 2. Every other day
 3. Semiweekly
 4. Weekly
- 8-4. In addition to being used to register officers, the reverse side of the Registration Record, NAVCOMPT Form 2104, may be used at afloat activities to perform what other function?
1. List an officer's required stateroom services
 2. List an officer's personal effects
 3. Record an officer's lineal number
 4. Record financial transactions
- 8-5. When you find an item of an official or personal nature left in sight while cleaning an officer's stateroom, what action(s) should you take?
1. Place the item in a drawer and inform the officer
 2. Examine the item to determine if it should be left out
 3. Take the item immediately to the officer
 4. Immediately report the situation to the officer
- IN ANSWERING QUESTIONS 8-6 THROUGH 8-9, SELECT THE REQUIRED FREQUENCY THAT THE STATEROOM CLEANING TASK GIVEN AS THE QUESTION SHOULD BE PERFORMED.
- 8-6. Clean washbasin, mirror, soap container, and toothbrush holders.
1. Daily
 2. Weekly
 3. Monthly
 4. Quarterly
- 8-7. Scrub and wax deck or spot-check carpet and remove stains as scheduled.
1. Daily
 2. Weekly
 3. Monthly
 4. Quarterly
- 8-8. Turn mattress over and vacuum underneath.
1. Daily
 2. Weekly
 3. Monthly
 4. Quarterly

- 8-9. Send draperies, curtains, chair covers, and bedspreads for dry cleaning.
1. Daily
 2. Weekly
 3. Monthly
 4. Quarterly
- 8-10. At what paygrade does an officer become entitled to bed-making services?
1. O-1
 2. O-3
 3. O-5
 4. O-4
- 8-11. Which of the following services is considered personal in nature and is the responsibility of individual officers?
1. Delivering and picking up officer's laundry
 2. Replacing soiled hand and bath towels
 3. Sorting and storage of officer's laundry
 4. Replacing stripped linens with fresh ones
- 8-12. What person or organization assigns responsibility for providing administrative and technical guidance for operating Navy BQs?
1. BQ MAIT
 2. BUPERS
 3. CNO
 4. CNP
- 8-13. The BQ management organization headquarters has which of the following responsibilities?
1. Development and implementation of local rules and regulations
 2. Evaluating the habitability, occupancy criteria, and design of BQs
 3. Setting up a continuing training program for all operating personnel
 4. Approval of all authorizations for payment of basic allowance for quarters (BAQ, single)
- 8-14. BUPERS works with what organization in establishing and improving BQ management training?
1. CNET
 2. DPSC
 3. NAVFSSO
 4. NAVSUP
- 8-15. What organization actually inspects BQ operations to ensure compliance with NAVPERS 15606 and other applicable directives?
1. CNET
 2. MAIT
 3. NAVFSSO
 4. NFMT
- 8-16. Information and requirements concerning BQ civilian employees that are paid with nonappropriated funds are provided by which of the following references?
1. NAVPERS 15606
 2. SECNAVINST 5300.22
 3. *Federal Personnel Manual*
 4. *Custodial Services Manual*
- 8-17. The use of a centralized management system within a BQ accomplishes which of the following results?
1. Better financial accountability
 2. Greater occupancy of quarters
 3. Savings in resources
 4. Each of the above

- 8-18. The BQ advisory committee performs which of the following duties?
1. Reviews all reports containing BQ information
 2. Gives residents direct line of communication to management and command
 3. Develops BQ requirements surveys
 4. Authorizes work requests for BQ preventive maintenance
- 8-19. The BQ advisory committee members are appointed by the commanding officer based on the number of BQ occupants.
1. True
 2. False
- 8-20. In a BQ operation, what person maintains and is accountable for nonappropriated funds?
1. Host commanding officer
 2. Tenant commanding officer
 3. Supply petty officer
 4. BQ officer
- 8-21. In what manner should BQ residents be first informed of their responsibilities while living in quarters?
1. Welcome aboard package
 2. Personal interview with BQ officer
 3. By the front desk clerk at the time of arrival
 4. During command indoctrination
- 8-22. The front desk clerk should read and become familiar with which of the following publications to be an effective contact point for a BQ operation?
1. *Custodial Services manual*
 2. *DOD Housing Management Manual*
 3. *Navy Customer Service Manual*
 4. *Shore facilities planning Manual*
- 8-23. Which of the following information is NOT required to be included in a welcome aboard pamphlet?
1. Command letter of welcome
 2. Base map
 3. applicable service charges for rooms
 4. List of all services provided by the base
- 8-24. When suggestion boxes are located in each BQ building, what individual(s) should maintain the key to open the boxes?
1. BPO
 2. BQ officer
 3. Commanding officer
 4. Front desk clerk
- 8-25. When the cashier being relieved turns over the change fund to the relieving cashier, what type of change fund is this called?
1. Satellite
 2. Turnover
 3. Revolving
 4. Orbiting
- 8-26. When closing out a cash register, what person is responsible for filling out lines 11 through 18 of the Daily Activity Record?
1. Cashier
 2. Person verifying the charges and cash received
 3. Person designated to read the cash register
 4. BQ officer
- 8-27. What BQ staff member should have sole possession of the key to the baggage storeroom?
1. BPO
 2. SPO
 3. BEQ or BOQ officer
 4. Front desk clerk

- 8-28. Who normally determines the general area in which the personnel will be fed in a field kitchen operation?
1. Supply officer
 2. Medical representative
 3. Shore party commander
 4. Senior MS
- 8-29. When you are selecting a site for a field kitchen, which of the following factors is desirable if possible?
1. Ground that is high and dry
 2. A good water supply
 3. Ample distance from heads
 4. An access road for kitchen traffic only
- 8-30. When you are using water from field sources, the water is considered potable only under what condition?
1. When a bacterial analysis has been made
 2. When you observe animals drinking it
 3. When the sediment has been filtered out
 4. When the source is either a well or a spring
- 8-31. When you are planning to use groundwater in a field mess operation, which of the following sources of groundwater is considered better than surface water?
1. A brook
 2. A spring
 3. A lake
 4. A pond
- 8-32. When given a choice of water sources, you should choose the clearest water possible for which of the following reasons?
1. It provides the most minerals
 2. It has a better taste
 3. It is easier to disinfect
 4. It is a guarantee of safety
- 8-33. You should include what chemical in the cleaning process of water receptacles?
1. Caustic soda
 2. Potassium permanganate
 3. Fluorine
 4. Tincture of iodine
- 8-34. A head or latrine should be located what minimum distance from the field kitchen?
1. 75 feet
 2. 75 yards
 3. 100 feet
 4. 100 yards
- 8-35. All EXCEPT which of the following storage methods provides temperature protection for perishable foods?
1. Suspended food box
 2. Root cellar
 3. Watertight container set in a cool stream
 4. Underground food box
- 8-36. The best location for you to construct a root cellar is in what type of terrain?
1. Flat
 2. Rocky
 3. Hilly
 4. Sandy

- 8-37. The insulation used for a double-walled food box should consist of which of the following materials?
1. Ice
 2. Grass
 3. Dirt
 4. Gravel
- 8-38. The area used to bury garbage should be dug to what minimum number of feet deep?
1. 6
 2. 2
 3. 8
 4. 4
- 8-39. Excess moisture should be removed from garbage when it is to be handled in which of the following manners?
1. Burned
 2. Ground
 3. Buried
 4. Crushed
- 8-40. A cross-trench incinerator functions best under what condition?
1. When the ground surface of the entire trench is uniformly 12 inches deep
 2. When the bottom of each trench tapers downward at their ends
 3. When the trench is made to use gasoline for fuel
 4. When the one end that is open faces the wind
- 8-41. When cans and jars are no longer needed, you should handle them in all EXCEPT which of the following manners?
1. Flattening or breaking them
 2. Burying them with the garbage
 3. Establishing a central refuse pile for them
 4. Washing them and then using them for cooking or eating utensils
- 8-42. A soakage pit should be located at least what minimum number of feet from the kitchen area?
1. 15
 2. 25
 3. 50
 4. 75
- 8-43. What size is the general-purpose tent that is designed for field kitchen use?
1. Small
 2. Medium
 3. Large
 4. Jumbo
- 8-44. All EXCEPT which of the following actions should be performed during the component and maintenance check you do before erecting and after disassembling a tent?
1. Inspect the tent body for abrasions and mildew
 2. Check the tent lines for frayed or raveled ends
 3. Check tent pins for sharpness
 4. Inspect slide fasteners for damage and freedom of movement
- 8-45. What specific number of M59 field ranges will you need to feed 99 people?
1. 1
 2. 2
 3. 3
 4. 4
- 8-46. The gasoline field range can be used for all EXCEPT which of the following cooking methods?
1. Baking
 2. Roasting
 3. Broiling
 4. Frying

- 8-47. All EXCEPT which of the following actions is a step in lighting the M2 burner unit?
1. Filling the tank until fuel can be seen at the base of the filler cap
 2. Pumping until the gauge reads 20 to 30 pounds
 3. Allowing the preheater burner head to burn for 30 seconds
 4. Setting the air shutter handle in a half-open position
- 8-48. Which of the following statements is a safety precaution you should observe when operating the M2 burner unit?
1. Periodically vent air pressure
 2. Use only kerosene as fuel
 3. Do not operate beyond 10 pounds of pressure
 4. do not refuel a hot unit
- 8-49. The small detachment cooking outfit is designed to prepare rations for what maximum number of people?
1. 25
 2. 40
 3. 65
 4. 100
- 8-50. The small detachment cooking outfit is designed for outdoor use and cannot be used indoors under any circumstances.
1. True
 2. False
- 8-51. The immersion-type heater is used primarily to accomplish which of the following tasks?
1. Sterilizing water supplies
 2. Melting snow and ice into water
 3. Heating water used for washing and sanitizing
 4. Fueling an improvised stove
- 8-52. Which of the following statements is a precaution that must be observed if an immersion-type heater is used to heat a tent in an emergency?
1. A carbon monoxide filter must be installed
 2. Only gasoline may be used for fuel
 3. A 30-gallon can must be used
 4. The resulting fumes must be vented outside
- 8-53. What is the prescribed fuel for the immersion-type heater?
1. Gasoline
 2. Fuel oil
 3. Kerosene
 4. Diesel oil
- 8-54. The tank-trailer heater also may be used in emergencies to heat a tent as long as you follow the same provisions that apply to using the immersion-type heater for that purpose.
1. True
 2. False
- 8-55. You can construct a good chimney for an improvised stove by using which of the following materials?
1. Bricks
 2. Hardened mud
 3. A tin can
 4. A hollow log
- 8-56. In cold weather, you should place the field ranges in what location within the tent?
1. In the center
 2. Along the side walls
 3. Near the doors
 4. Next to the serving line

8-57. A corrugated can of boiling water should be placed at the head of the serving line area for which of the following reasons?

1. To hold used serving utensils
2. To partly sanitize eating utensils
3. To keep serving utensils moist in cold weather
4. To reconstitute dehydrated MREs

8-58. When you are using emergency cooking facilities, you may only use galvanized cans for which of the following purposes?

1. To cook, stew
2. To prepare lemonade
3. To store vinegar
4. To store flour

8-59. A field dishwashing unit consists of what specific number of corrugated cans?

1. One
2. Five
3. Three
4. Six

8-60. The field dishwashing battery should be set up to allow you to sanitize field mess eating utensils in what manner?

1. Soaking in a solution of potassium permanganate
2. Immersing in two cans of boiling water for 30 seconds
3. Immersing in a chlorine solution only
4. Dipping into one can boiling water and a second can containing a chlorine solution

IN ANSWERING QUESTION 8-61, REFER TO FIGURE 11--12.

8-61. Wash water used for field dishwashing should be maintained within what specific temperature range?

1. 120°F to 140°F
2. 130°F to 150°F
3. 140°F to 160°F
4. 150°F to 180°F

8-62. What person is responsible for rodent control in a field mess operation?

1. Leading MS
2. Shore party commander
3. Medical officer
4. Galley watch captain

